

Science with Passion



Azura

SMB systems Instructions



Document no. V6775



Note: For your own safety, read the instructions and follow the warnings and safety information on the device and in the instructions. Keep the instructions for future reference.



Note: In case you require this instruction in another language, submit your request including the corresponding document number via e-mail or fax to KNAUER.

Support: Do you have questions about the installation or the operation of your instrument or software?

International Support:

Contact your local KNAUER partner for support:

www.knauer.net/en/Support/Distributors-worldwide

Support in Germany

(Austria & Switzerland on case-to-case basis):

Phone: +49 30 809727-111 (workdays 9-17h CET)

Fax: +49 30 8015010

E-mail: support@knauer.net

Publisher: KNAUER Wissenschaftliche Geräte GmbH

Hegauer Weg 38

14163 Berlin

Germany

Phone: +49 30 809727-0

Fax: +49 30 8015010

Internet: www.knauer.net

E-mail: info@knauer.net

Version information: Document number: V6775

Version number: 2.2

Release date: March 03, 2024

Original edition

The information in this document is subject to change without prior notice. For the latest version of the instructions, visit our website: www.knauer.net/library.



Copyright: This document contains confidential information and may not be reproduced without written consent of KNAUER Wissenschaftliche Geräte GmbH.

© KNAUER Wissenschaftliche Geräte GmbH 2024

All rights reserved.

AZURA® is a registered trademark of KNAUER Wissenschaftliche Geräte GmbH.

Table of contents

1. Product information	1
1.1 Intended use	1
1.2 AZURA® SMB system variants	1
1.2.1 AZURA® SMB Lab	1
1.2.2 AZURA® SMB Pilot	2
1.3 System configuration	3
1.3.1 AZURA® SMB Lab	4
1.3.2 AZURA® SMB Pilot	4
2. Scope of delivery	5
2.1 AZURA® SMB Lab System	5
2.2 AZURA® SMB Pilot System	6
3. General	7
3.1 About these instructions	7
3.2 Signal words	7
3.3 Additional typographical conventions	7
3.4 Legal information	8
3.4.1 Liability limitation	8
3.4.2 Transport damage	8
3.4.3 Warranty conditions	8
3.4.4 Warranty seal	8
3.4.5 Declaration of conformity	8
4. Basic safety instructions	9
4.1 Intended use	9
4.1.1 Operating ranges	9
4.1.2 Foreseeable misuse	9
4.2 User qualification	9
4.3 Operator responsibility	10
4.4 Personal safety equipment	10
4.5 Safety features on the device	10
4.6 Working with solvents	11
4.6.1 General requirements	11
4.6.2 Contamination by health-threatening solvents	11
4.6.3 Avoiding leakage	11
4.7 Specific environments	11
4.7.1 Earthquake-endangered areas	11
4.7.2 Explosive environment	12
4.7.3 Cooling room	12
4.7.4 Wet room	12
4.8 Maintenance, care and repair	12
4.9 Service request form and decontamination report	12
4.10 Symbols and signs	13

5. Unpacking and setup	14
5.1 Operating environment	14
5.1.1 Space requirements	14
5.1.2 General requirements	14
5.1.3 Earthquake areas	14
5.2 Storing unopened shipping boxes	15
5.3 Unpacking	15
5.4 Power supply	16
5.5 Connecting the capillaries	16
5.6 Flow charts	17
5.7 Connecting system to computer via LAN	18
5.7.1 Connecting the single devices to the computer	18
5.7.2 Configuring LAN settings	18
5.7.3 Connecting devices with LAN	19
5.7.4 Configuring the switch	20
5.7.5 Integrating LAN into the company network	20
5.7.6 Controlling several systems separately in a LAN	21
5.7.7 Remote control	21
5.7.8 Connecting the pin header	22
6. Start-up	24
6.1 Initial start-up checklist	24
6.2 SOP: SMB power-up and shut-down	24
6.2.1 Power-up	24
6.2.2 Shut down	25
6.3 SOP: SMB start-up	26
6.3.1 Preparation	27
6.3.2 Flushing the system	28
6.3.3 Washing one single column	29
6.3.4 Flushing all columns	30
6.3.5 Washing all columns	31
7. Simulated Moving Bed principle	32
7.1 Introduction	32
7.2 Elution chromatography	32
7.3 True counter-current process	35
7.4 Simulated counter-current process	37
7.5 Efficiency and economic aspects	39
8. Operation	41
8.1 Software operation	41
8.2 Meaning of the LEDs	41
8.3 Connecting the columns	42
8.3.1 AZURA® SMB Lab system	42
8.3.2 AZURA® SMB Pilot system	44
8.4 SOP: AZURA® SMB separation	44
8.4.1 Preparation	45
8.4.2 Starting the system	45

8.4.3	Pausing the separation	46
8.4.4	Stopping the separation	47
8.5	Change Zone configurations	47
8.5.1	From 2:2:2:2 to 1:3:3:1	47
8.5.2	User defined configuration	49
8.5.3	From 2:2:2:2 to 1:1:1:1	50
8.6	Adjusting the flow rate of the pump	50
8.7	Inline sampling valve	51
8.8	Sampling valve	53
9.	Functionality tests	55
9.1	Installation Qualification (IQ)	55
9.2	Operation Qualification (OQ)	55
10.	Troubleshooting	56
10.1	First measures	56
10.2	LAN	56
10.3	Possible problems and solutions	57
11.	Maintenance and care	58
11.1	SOP: Cleaning procedure for pressure release valves and connected tubings for AZURA® Pilot SMB	58
11.2	Maintaining the AZURA® Lab System	58
11.2.1	Pumps	58
11.2.2	Valves	59
11.3	Maintaining the AZURA® Pilot system	59
11.3.1	Pumps	59
11.3.2	Valves	60
11.4	Decommissioning	60
11.5	Transport	60
11.6	Storage	61
11.6.1	Disconnecting the power supply	61
12.	Technical data	62
12.1	General system parameters	62
12.2	Technical parameters	62
12.3	Wetted materials	63
13.	Reorders	64
13.1	Heating and column organisation	64
13.2	System and process control	64
13.3	Services	65

14. Chemical compatibility of wetted materials	66
14.1 General	66
14.2 Plastics	66
14.3 Non-metals	68
14.4 Metals	69
15. Disposal	70
15.1 AVV-Marking Germany	70
15.2 WEEE registration number	70
15.3 Eluents and other operating materials	70
16. Checklist	71

1. Product information

1.1 Intended use



Note: Only use the system for applications that fall within the range of the intended use. Otherwise, the protective and safety equipment of the system could fail.

Application	Separation and extraction
Pharmaceutical chemistry	Chiral compound (cis-trans phytol, steroids, peptides, antibiotics, etc.)
Food chemistry	Fatty acids, carbohydrate mixtures (sucrose/molasses, fructose/glucose, etc.)
Biochemistry	Phenylalanine, fermentation/cell culture products (citric acid, sugars, antibodies, enzymes, etc.)
Petrochemistry	C8-Hydrocarbon (xylene/toluene, etc.)

1.2 AZURA® SMB system variants

1.2.1 AZURA® SMB Lab

This SMB system is optimized for separation tasks on a scale of several hundred grams. The standard configuration consists of four AZURA® assistants ASM 2.2L with seven multi-position valves and four AZURA® pumps P 4.1S as well as our user-friendly software PurityChrom® MCC including required IT hardware.

Depending on the specific requirements of each separation, the SMB system can be freely configured. For example an open or closed SMB loop is created by a specific valve switching. Optionally, the SMB can be upgraded with detectors, flowmeters, column holders, leak sensors or temperature control options for the columns.

Individual configuration is available on request.

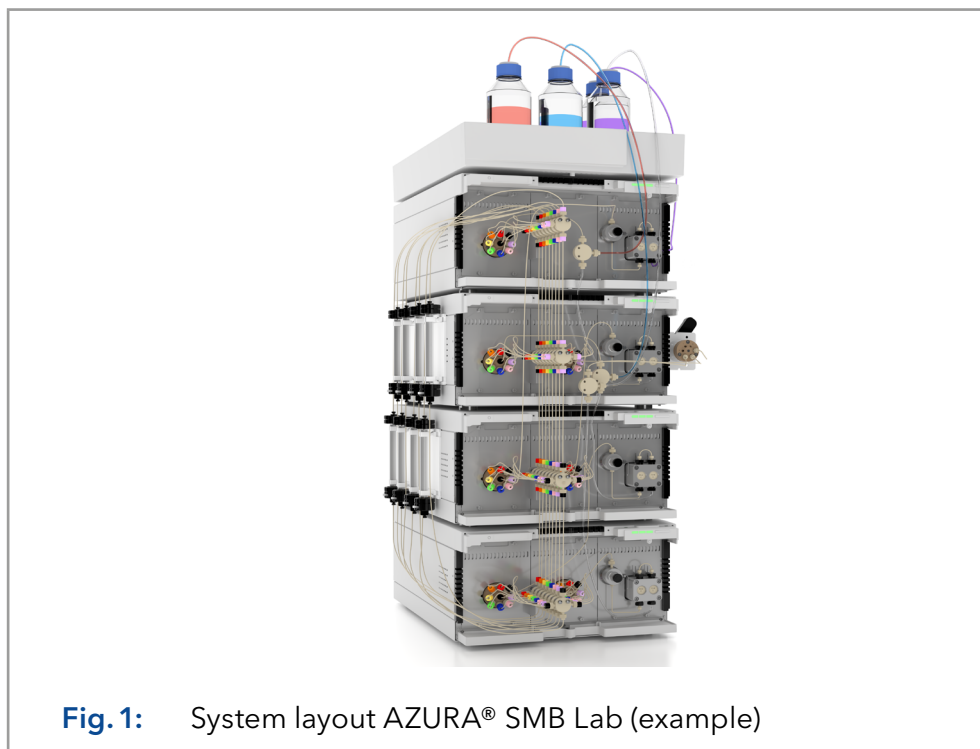

1.2.2 AZURA® SMB Pilot

The AZURA® SMB Pilot is designed for the separation of binary mixtures on a hundred gram to kilogram scale and is typically used with columns up to 50 or 100 mm inner diameter. Its special emphasis is put on the continuous operation mode and highest productivity.

The SMB standard configuration consists of four BlueShadow pumps 80P and seven 8-port multiposition valves integrated into four AZURA® assistants ASM 2.2L. By integrating 4 flowmeters, the flow rates of all pumps are monitored. Our user-friendly software PurityChrom® MCC and the required IT hardware are also included. Depending on the specific requirements of each separation, you can freely configure the SMB system. For example an open or closed SMB loop is created by a specific valve switching. Optionally, you can upgrade the SMB Pilot with detectors, flowmeters, column holders, or temperature control options for the columns.

We offer several variations of the standard system configuration.



Fig. 2: System layout AZURA® SMB Pilot (example)

1.3 System configuration

The standard AZURA® SMB systems consists of four pumps and seven multi-position valves.

The devices are arranged as follows:

- Three pumps (Extract, Raffinate, Eluent) are placed inside the SMB cycle.
- The feed pump is placed outside the SMB cycle.
- Four valves are placed at the pump outlets.
- Three valves are placed at the pump inlets. The feed pump inlet is not connected to a multiposition valve.

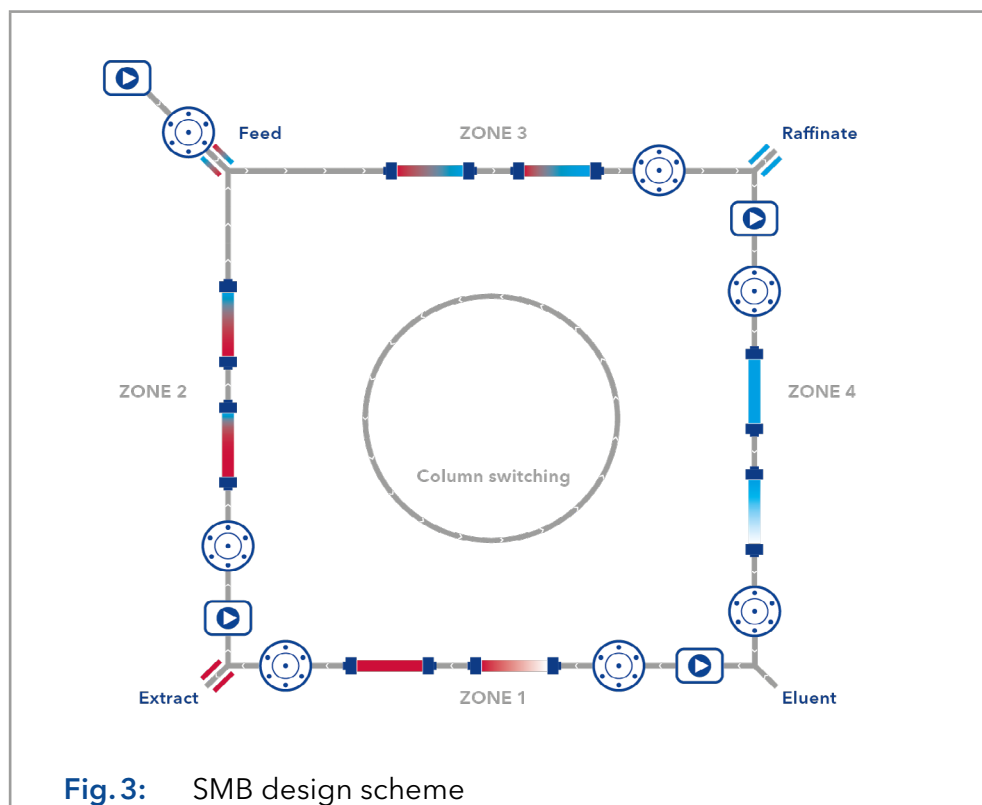

1.3.1 AZURA® SMB Lab

Max. continuous flow rate*		Number of columns	Pressure range	Art. No.	Description
Zone 1	Feed				
30 ml/min	4 ml/min	8	5 - 130 bar	A29100	Biocompatible (PAEK, ceramic)
30 ml/min	4 ml/min	8	5 - 130 bar	A29101	Stainless steel

* The maximum operating parameters for flow and pressure depend on the specific columns and customer application.

1.3.2 AZURA® SMB Pilot

Max. continuous flow rate*		Number of columns	Pressure range*	Art. No.	Description
Zone 1	Feed				
250 ml/min	40 ml/min	8	2 - 100 bar	A29201	Standard (stainless steel)
400 ml/min	100 ml/min	8	2 - 60 bar	A29202	High flow (stainless steel)

* The maximum operating parameters for flow and pressure depend on the specific columns and customer application.

2. Scope of delivery



Note: Only use original parts and accessories made by KNAUER or a company authorized by KNAUER.

2.1 AZURA® SMB Lab System

- 1 x AZURA® Assistant ASM 2.2L with 1 x AZURA® Pump P 4.1S (10 ml pump head) and 1 x 8-Multiposition-valve
- 3 x AZURA® Assistant ASM 2.2L with 1 x AZURA® Pump P 4.1S (50 ml pump head) and 2 x 8-Multiposition-valve
- SMB-Set with 1/16" capillaries, screw connections, T-pieces and connections for the assembly of the system
- Open/Closed Loop Kit
- PurityChrom® MCC control software
- Eluent tray AZURA® E 2.1L
- Chromatography Work station with Mini-PC and 24" monitor
- Switch

Stainless Steel version:

- Pump heads (stainless steel)
- Multiposition-valve-head (stainless steel)
- Capillaries (stainless steel)

Biocompatible version:

- Pump heads (ceramic)
- Multiposition valve head (PEEK)
- Capillaries (PEEK)

Optional:

- Flowmeter
- Oven
- Detectors
- Column holders
- Leak sensors

Valid documents:

- Instructions for AZURA® SMB system (document no. V6775)
- Declarations of conformity for single devices

2.2 AZURA® SMB Pilot System

- 1 x AZURA® Assistant ASM 2.2L with 1 x 8-Multiposition-valve (valve head: stainless steel)
- 3 x AZURA® Assistant ASM 2.2L with 2 x 8-Multiposition-valves (valve head: stainless steel)
- 4 x BlueShadow pump 80P (pump head: stainless steel)
- 4 x flowmeter included
- SMB-set with 1/8" capillaries, screw connections, T-pieces and connections for the assembly of the system (stainless steel)
- Open/Closed Loop Kit
- Inline sampling valve
- PurityChrom® MCC control software
- Chromatography Work station with Mini-PC and 27" monitor
- Switch

Standard version:

- 3 x BlueShadow pump 80P (500 ml pump head)
- 1 x BlueShadow pump 80P (100 ml pump head)

High flow version:

- 3 x BlueShadow pump 80P (1000 ml pump head)
- 1 x BlueShadow pump 80P (250 ml pump head)

Optional:

- Oven
- Detectors
- Column holders

Valid documents:

- Instructions for AZURA® SMB system (document no. V6775)
- Declarations of conformity for single devices

3. General

3.1 About these instructions

These operating instructions enable the safe and efficient operation of the device. The user has to read these operating instructions carefully before starting any work.





The basic prerequisite for safe operation is compliance with all safety instructions (see chapter „4. Basic safety instructions“ on page 9). In addition to the safety and warning instructions in these operating instructions, the local accident prevention regulations and the national industrial safety regulations apply.

These operating instructions are an integral part of the device. It has to be kept in the immediate vicinity of the device and accessible to the user at all times.

You can download these and other instructions from the KNAUER website: www.knauer.net/library

3.2 Signal words

Possible dangers related to the device are distinguished in personal and material damages.

Symbol	Meaning
	DANGER (red) indicates a highly hazardous situation. If not avoided, it will result in death or serious injury.
	WARNING (orange) indicates a hazardous situation. If not avoided, it could result in death or serious injury.
	CAUTION (yellow) indicates a moderate hazardous situation. If not avoided, it could result in minor or moderate injury.
	NOTICE (blue) is used to address issues which are not related to physical injury.

3.3 Additional typographical conventions

Note: Specific information are prefixed with the word “Note” and an information icon.



Note: This is an example.

3.4 Legal information

3.4.1 Liability limitation

The manufacturer is not liable for the following issues:

- Non-compliance of these instructions
- Non-observance of necessary safety precautions
- Improper use
- Operation of the device by unqualified personnel (see chapter „4.2 User qualification“ on page 9)
- Use of non-approved spare parts
- Technical changes by the user such as opening the device and unauthorized modifications
- Violations of General Terms and Conditions (GTC)

3.4.2 Transport damage

The packaging of our devices provides the best possible protection against transport damage. However, check the packaging for transport damage. In case you notice any damage, inform the Technical Support and the shipping company within three workdays.

3.4.3 Warranty conditions

For information on warranty please refer to our general terms and conditions on the website: www.knauer.net/terms

3.4.4 Warranty seal

A blue or orange warranty seal is affixed to some devices.

- A blue seal is used by KNAUER's Manufacturing or Customer Support for devices to be sold.
- After repair, service technicians attach an orange seal onto the identical position.

If unauthorised persons tamper with the device or if the seal is damaged, the warranty will lapse.



3.4.5 Declaration of conformity

The declaration of conformity is enclosed as a separate document with the product and can be obtained online:

www.knauer.net/en/Support/Declarations-of-conformity

4. Basic safety instructions

The device has been developed and constructed in such a way that hazards arising from its intended use are largely excluded. Nevertheless, the following safety instructions have to be observed in order to exclude residual hazards.

4.1 Intended use

Only use the device for applications that fall within the range of the intended use. Otherwise, the protective and safety equipment of the device could fail.

4.1.1 Operating ranges

The device is intended to be used indoors for chromatographic applications.

4.1.2 Foreseeable misuse

Refrain from the use of the device for the following purposes or conditions:

- Medical purposes. The device is not approved as a medical product.
- Operating outdoors. Otherwise, the manufacturer does not guarantee the functionality and safety of the device.
- Operation in potentially explosive areas without special and additional explosion protection. Contact the KNAUER Customer Support for more information.

4.2 User qualification

The users are qualified to handle the device if all of the following points apply:

- They have at least a basic knowledge of liquid chromatography.
- They have knowledge about the properties of the used solvents and their health risks.
- They are trained for the special tasks and activities in the laboratory and know the relevant standards and regulations.
- Due to their technical training and experience, they can understand and carry out all the work described in the operating instructions on the instrument and recognize and avoid possible dangers independently.
- Their ability to react is not impaired by the consumption of drugs, alcohol or medication.
- They have participated in the installation of an instrument or a training by KNAUER or an authorized company.

If users do not meet these qualifications, they have to inform their supervisors.

4.3 Operator responsibility

The operator is any person who operates the device himself or leaves it to a third party for use and who bears the legal product responsibility for the protection of the user or third parties during operation.

The obligations of the operator are listed below:

- Know and follow the applicable work safety regulations
- Identify hazards arising from the working conditions at the place of use in a risk assessment.
- Set up operating instructions for the operation of the device.
- Regularly check whether the operating instructions correspond to the current status of the regulations.
- Clearly regulate and specify responsibilities for installation, operation, troubleshooting, maintenance and cleaning and set clear rules
- Ensure that all personnel who work with the device have read and understood these operating instructions
- Train the personnel who works with the device at regular intervals and inform them about the dangers.
- Provide the necessary safety equipment to the employees working with the unit (see section below).

4.4 Personal safety equipment

The protective measures required in the laboratory must be observed and the following protective clothing worn during all work on the device:

- Safety glasses with side protection
- Protective gloves in accordance with the prevailing ambient conditions and used solvents (e.g. heat, cold, protection against chemicals)
- Lab coat
- Personalised protective safety equipment which is specified in the particular laboratory.

4.5 Safety features on the device

- Power switch: Devices of the AZURA® L series may be switched off using the power switch (toggle switch on the back side of housing) at any time, this causes no damage to the device. To switch off devices of the AZURA® S series, remove the plug from the power socket or use the toggle switch of the power supply unit.
- Front cover: Devices of the AZURA® L series have a front cover as a splash protection for the user
- Leak tray: Devices of the AZURA® L series have a leak tray on the front side. The leak tray collects leaking solvents and protects components from potential damage caused by discharging liquid.
- Lamp: For the detectors AZURA® DAD 2.1L, DAD 6.1L and MWD 2.1L, the lamp switches off automatically when the cover is opened.

4.6 Working with solvents

4.6.1 General requirements

- The user is trained for handling different solvents.
- Note recommended solvents and concentrations in these instructions in order to avoid personal injury or damage to the device. For example, certain chemicals may cause PEEK capillaries to swell or burst (see chapter „14. Chemical compatibility of wetted materials“ on page 65).
- Note that organic solvents are toxic above a certain concentration. For handling hazardous solvents see the following section.
- Mobile phases and samples may contain volatile or combustible solvents. Avoid the accumulation of these substances. Ensure good ventilation of the installation site. Avoid open flames and sparks. Do not operate the instrument in the presence of flammable gases or vapors.
- Only use solvents which do not self-ignite under given conditions. This applies especially to the use of a thermostat where liquids could get onto hot surfaces in the interior.
- Degas solvents before use and observe their purity.

4.6.2 Contamination by health-threatening solvents

- Contamination with toxic, infectious or radioactive substances poses a hazard for all persons involved during operation, repair, sale, and disposal of a device.
- All contaminated devices have to be decontaminated properly by a specialist company or the operating company before they can be recommissioned, repaired, sold, or disposed (see chapter „11.4 Decommissioning“ on page 59).

4.6.3 Avoiding leakage

Risk of electrical shock or short circuit if solvents or other liquids leak into the interior of the device. You can avoid a leakage through the following measures:

- Tightness: Visually check the device or system regularly for leaks.
- Solvent tray: The use of a solvent tray prevents liquids get from the bottles into the inside of the device.
- Eluent lines: Install capillaries and hoses in such a way that, in case of a leak, liquids cannot get into the interior of the devices underneath.
- In case of leakage: Switch off the system. Only take the device into operation if the cause of the leak has been resolved.

4.7 Specific environments

4.7.1 Earthquake-endangered areas

In earthquake-endangered areas, do not stack more than 3 devices on top of each other. Otherwise there is risk of injury due to falling devices or loose parts.

4.7.2 Explosive environment

Never use the system in potentially explosive atmospheres without appropriate protective equipment. For more information, contact the KNAUER Customer Support.

4.7.3 Cooling room

You may operate the device in a cooling room. To prevent condensation, note the following instructions:

- Allow the device to acclimatize for min. 3 hours before taking it into operation.
- After taking into operation, the device should stay switched on.
- Avoid temperature fluctuations.

4.7.4 Wet room

Do not operate the device in wet rooms.

4.8 Maintenance, care and repair









- Avoiding electric shock: Before performing any maintenance and service work, disconnect the device from the power supply.
- Tools: Use only tools recommended or prescribed by the manufacturer.
- Spare parts and accessories: Only use original parts and accessories made by KNAUER or a company authorized by KNAUER.
- PEEK fittings: Use PEEK fittings only for a single port or brand-new PEEK fittings in order to avoid dead volume or not exactly fitting connections.
- Column care: Follow KNAUER or other manufacturer's instructions on caring for the columns (see www.knauer.net/columncare)
- Used capillaries: Do not use any used capillaries elsewhere in the system in order to avoid dead volumes, not exactly fitting connections and spreading contamination.
- Safety features: The device may only be opened by the KNAUER Customer Support or any company authorized by KNAUER (see chapter „3.4.1 Liability limitation“ on page 8).
- For more information visit the KNAUER website: www.knauer.net/hplc-troubleshooting

4.9 Service request form and decontamination report

Devices which are shipped without the completed document "Service request form and decontamination report" will not be repaired. If you would like to return a device to KNAUER, make sure to enclose the completed document: www.knauer.net/servicerequest

4.10 Symbols and signs

The following symbols and signs can be found on the device:

Symbol	Meaning
	High-voltage hazard
	Electrostatic discharge hazard, damages to system, device, or components can occur.
	Obey maximum load for leak tray during transportation, installation and operation.
	A device marked with CE fulfills the product specific requirements of European directives. This is confirmed in a Declaration of Conformity.
	The test seal of TÜV Germany, a nationally recognized testing agency (NRTL) in Canada and the USA. The certified device has successfully passed the tests for quality and safety.
	A warranty seal is affixed to some devices. For more information see Chapter (see chapter „3.4.4 Warranty seal“ on page 8).
	The device complies with the product-specific requirements of the United Kingdom.
	The device is covered by the Waste Electrical and Electronic Equipment Directive (WEEE Directive). It may not be disposed of as unsorted municipal waste and has to be collected separately. For more information (see chapter „15. Disposal“ on page 69).

5. Unpacking and setup

The HPLC system will be set up, installed and commissioned by KNAUER or a company authorized and contracted by KNAUER.



Note: KNAUER recommends inviting future users to be present while setting up and commissioning the module so that they can become familiar with the analyzer and how to handle it.

5.1 Operating environment

Only if the requirements for ambient conditions of the operating environment are met, the intended use can be ensured. Details on the operating conditions can be found in the chapter „Technical Data“.

5.1.1 Space requirements

- Make sure that the power plug on the power supply (wall socket or power strip) is always accessible, so that the device can be disconnected from the power supply.
- Ensure adequate ventilation around the device, otherwise it may overheat and malfunction:
 - Min. 5 cm distance if another device is set on one side.
 - Min. 10 cm distance if further devices are set on both sides.
 - At least 15 cm to the cooler fan on the rear.

5.1.2 General requirements

NOTICE

Device defect

The device overheats at exposure to sunlight and insufficient air circulation. Device failures are very likely.

- ➔ Set up the device in such a way that it is protected against exposure to direct sunlight.
- ➔ Leave room for air circulation: See paragraph “space requirements”.

- Position the device on a level and even surface.
- Protect the device against direct exposure to sunlight.
- Set up the device at a location not exposed to air drafts (A/C systems).
- Do not set up the device near other machines that cause floor vibrations.
- Keep the device away from high-frequency sources. High frequencies may compromise measuring values.

5.1.3 Earthquake areas

If you are located in an earthquake area, use the bore holes ① in the side panels to secure the device. The bore holes are located either on the right or the left side panel.



Fig.4: Bores holes in the side panel

5.2 Storing unopened shipping boxes

In your planning, include following information for immediate storage.

- Sufficient space
- Storage temperatures has to be in the temperature range 4 - 40 °C, 39 - 104 °F

5.3 Unpacking

Prerequisite ■ Check packaging for damage caused by transportation. If necessary, put forward any claim for damages to the carrier.

Tool ■ Utility knife

⚠ CAUTION

Bruising danger

Damage to the device by carrying or lifting it on protruding housing parts. The device may fall and thus cause injuries.

→ Lift the device only centrally on the side of the housing.

Process

- Procedure**
1. Place the packaging in such a way that the lettering on the label is in the correct position. Using the utility knife, cut the adhesive tape and open the packaging.
 2. Remove the foam insert. Take out the accessory kit and the instructions.
 3. Open the accessory kits and check the scope of delivery. In case any parts are missing, contact the Technical Support.
 4. Clasp the device from below, lift it out of the packaging and place it on its feet. Do not hold onto the front cover.

Process

5. Check the packaging, the device and the accessories for signs of transport damage. In case you notice any damage, contact the Technical Support.
6. Place the device in its site of operation and remove protective foil.

- Next steps**
- Keep the included packing list for repeat orders.
 - Keep the original packaging for safe storage or transportation.

5.4 Power supply

- Prerequisite**
- The electrical power supply at the installation site has to be connected directly to the nearest main power line.
 - The power has to be free from ripple, residual current, voltage peaks and electromagnetic interference.
 - The connectors for the mains voltage are grounded accordingly.
 - The device receives sufficient power with reserve capacity.
- Power cable**
- Use only the enclosed power cable to connect the device to the power supply to make sure that the specifications are met which are described in the chapter "Technical Data".
 - Beforehand, make sure to use power cables which are admitted for use in your country.
 - Replace defective power cables only with accessories from KNAUER.
 - Do not replace detachable power cables with different cable types.

NOTICE**Electronic defect**

Electronic hazard when using an identically constructed power adapter from another manufacturer.

- ➔ Only use spare parts and accessories from KNAUER or a company authorized by KNAUER.

- Power plug**
- The device is intended for use with AC power networks of 100 - 240 V.
 - Make sure that the power plug on the power supply (wall mounted socket or power strip) is always accessible, so that the device can be disconnected from the power supply.

5.5 Connecting the capillaries

NOTICE**Component defect**

Damage to components due to excessive tightening possible. Observe the torque of the screw connection.

- ➔ Use 5 Nm torque for stainless steel fittings.
- ➔ Use 1 Nm torque for PEEK fittings.

5.6 Flow charts

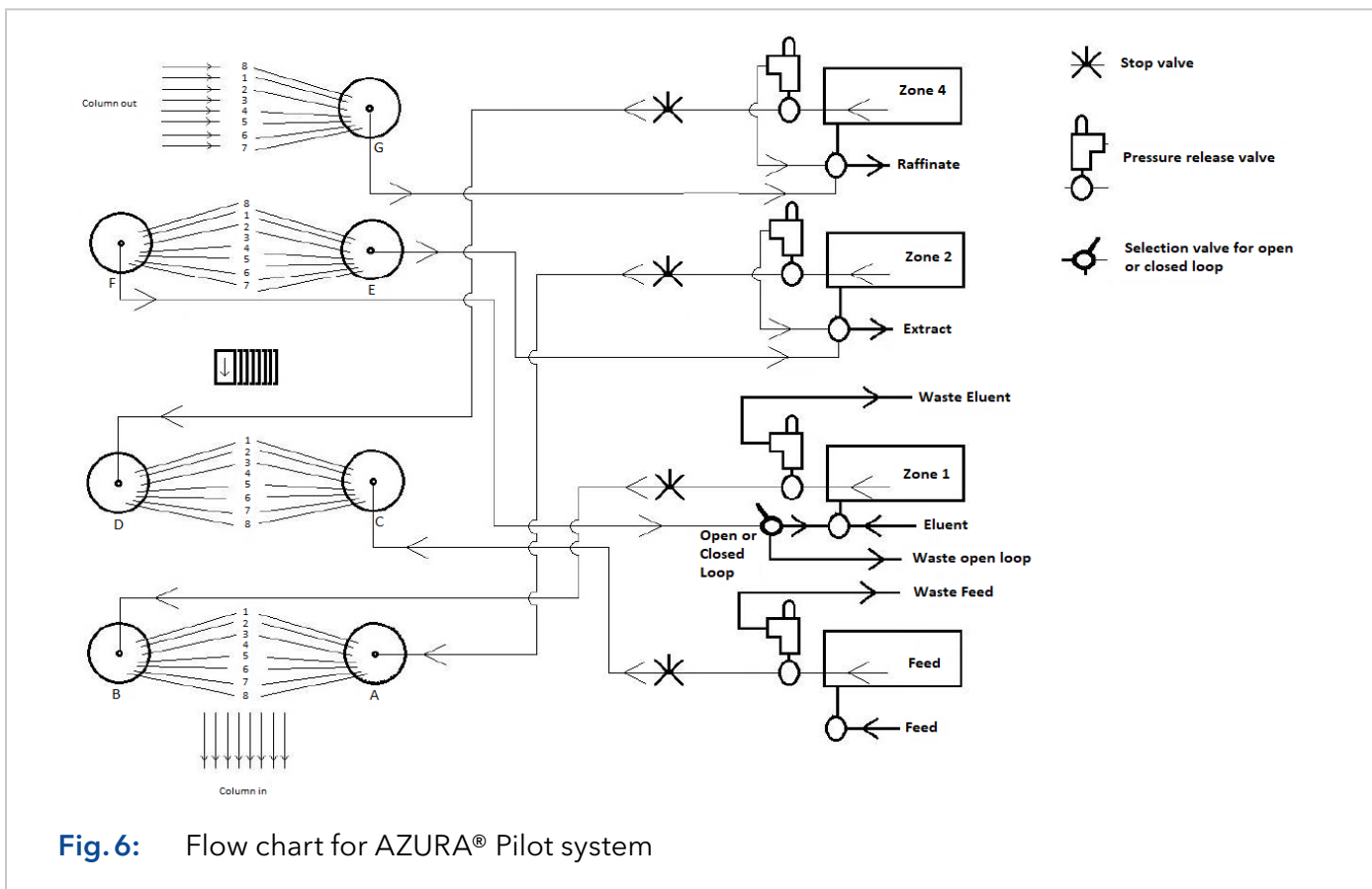
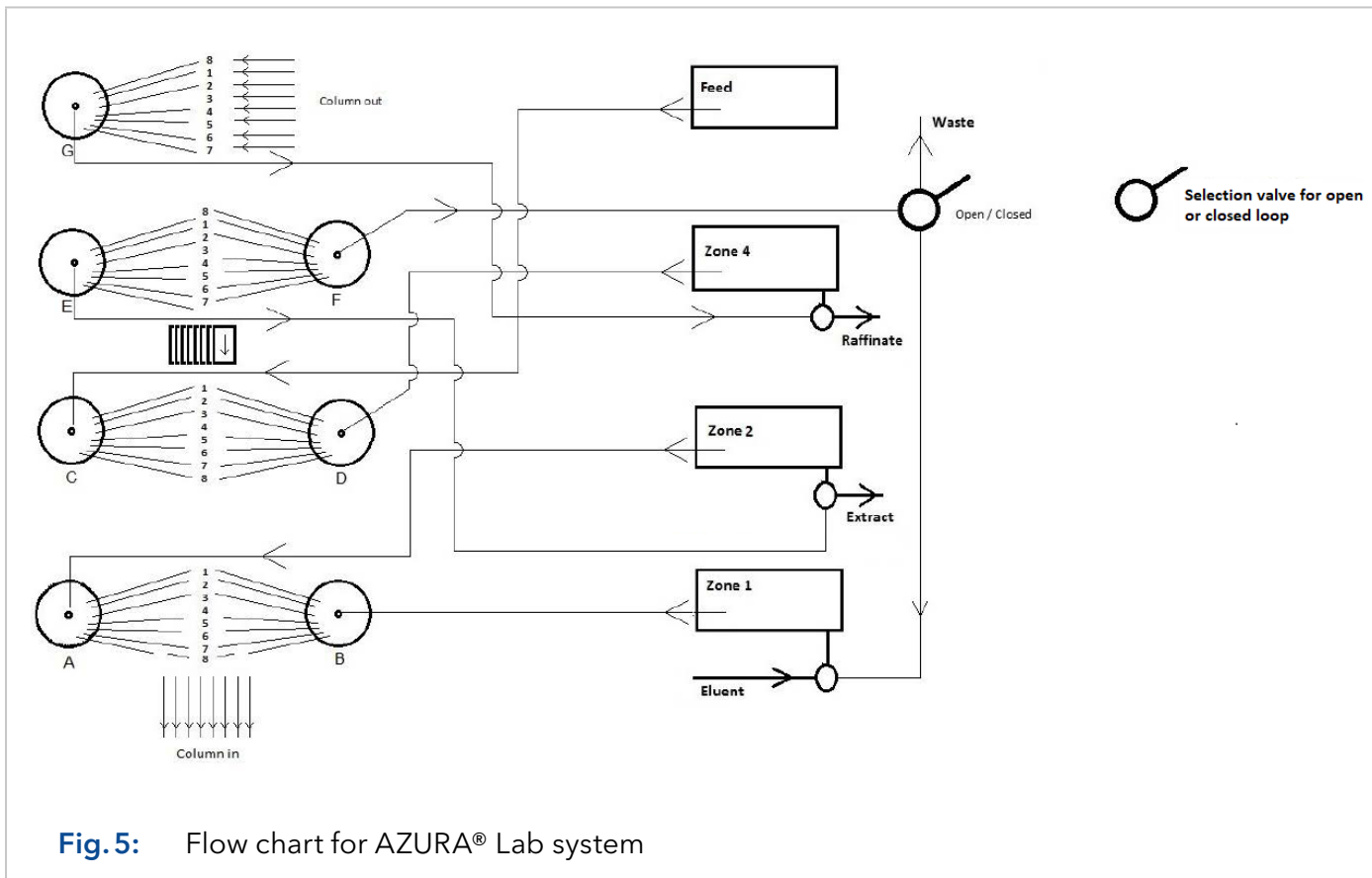

5.7 Connecting system to computer via LAN

The system can be operated in two ways:

- Via remote connector
- As part of a LAN, via the LAN connector of the router

All connectors for external control are located on the back side of the single devices.

5.7.1 Connecting the single devices to the computer



Note: HPLC devices made by KANUER work only with IP addresses which are assigned via IPv4. IPv6 is not supported.

This section describes how to set up an HPLC system in a local area network (LAN) and how a network administrator can integrate this LAN into your company network. The description applies to the operating system Windows and all conventional routers.

To set up a LAN, we recommend to use a router. That means the following steps are required:

Process	
Procedure	<ol style="list-style-type: none"> 1. On the computer, go to the control panel and check the LAN properties. 2. Connect the router to the devices and the computer. 3. Set up the router for the computer network. 4. Install the chromatography software. 5. Switch on the device and run the chromatography software.
Next step	<ul style="list-style-type: none"> ▪ Configure LAN properties (see chapter „1.1.2 Configuring LAN settings“ on page 13).

5.7.2 Configuring LAN settings

The LAN uses only one server (which is normally the router) from that the devices automatically receive their IP address.

Prerequisites	<ul style="list-style-type: none"> ▪ In Windows, power saving, hibernation, standby, and screen saver has to be deactivated. ▪ In case you use an USB-to-COM box, the option “Allow the computer to turn off this device to save power” in the Device Manager has to be deactivated for all USB hosts. ▪ Applies to all LAN devices: Disable the setting for the network adapter in Device Manager “Allow the computer to turn off this device to save power”.
----------------------	---

- Procedure**
- Process**
1. In Windows, open <Network and Sharing Center>.
 2. Double-click on <LAN connection>.
 3. Click on the button <Properties>.
 4. Select <Internet Protocol version 4 (TCP/IPv4)>.
 5. Click on the button <Properties>.
 6. Check the settings in the tab <General>. The correct settings for the DHCP client are:
 - a) Obtain an IP address automatically
 - b) Obtain DNS server address automatically
 7. Click on the button <OK>.
- Next step**
- Connect devices (see chapter „1.1.3 Connecting devices with LAN“ on page 14).

5.7.3 Connecting devices with LAN

A router ② has several LAN ports ③ and one WAN port ④ that can be used to integrate the LAN into a wide area network (WAN), e.g. a company network or the Internet. In contrast, the LAN ports serve to set up a network from devices ① and a computer ⑤. To avoid interference, we recommend operating the chromatography system separately from the company network.



Note: You will find patch cables for each device and the router in the accessories kit. To connect the router to a WAN, an additional patch cable is required, which is not supplied within the scope of delivery.

Legend:

- ① Devices
- ② Router
- ③ LAN ports
- ④ WAN/Internet connection
- ⑤ Computer

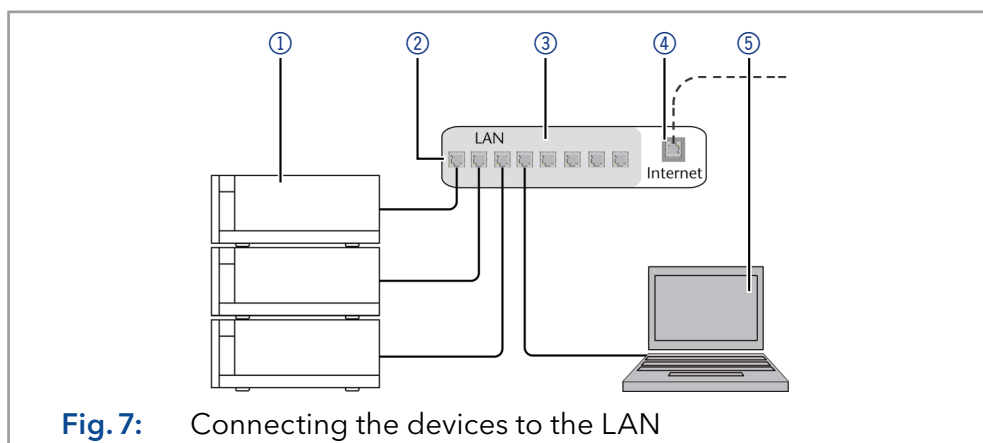

- Prerequisites**
- The computer is switched off.
 - There is a patch cable for each device and the computer.

- | | |
|------------------|---|
| | Process |
| Procedure | <ol style="list-style-type: none"> 1. Use the patch cable to connect the router and the computer. Repeat this step to connect all devices. 2. With additional patch cables, connect all devices individually with the router. 3. Use the power supply to connect the router to the mains power system. |
| Next step | <ul style="list-style-type: none"> ■ Set the router properties (see chapter „1.1.4 Configuring the router“ on page 14). |

5.7.4 Configuring the switch

The switch is preset at the factory. Information about address, user name and password is noted in the router manual: www.knauer.net/PC-hardware.

- | | |
|------------------|--|
| | Process |
| Procedure | <ol style="list-style-type: none"> 1. To open the switch configuration, start your Internet browser and enter the IP address (does not apply for all switches). 2. Enter user name and password. 3. Configure the switch as DHCP server. 4. In the switch configuration, check the IP address range and make changes if necessary. |



Note: If the IP address range has been changed, it is essential to note this information on the switch.

- | | |
|---------------|---|
| Result | <ul style="list-style-type: none"> ■ Once the switch has assigned IP addresses to all devices, the chromatography software can be used to remotely control the system. |
|---------------|---|

5.7.5 Integrating LAN into the company network

A network administrator can integrate the LAN into your company network. In this case you use the WAN port of the router.

- | | |
|----------------------|--|
| Prerequisites | <ul style="list-style-type: none"> ■ There is a patch cable for the connection. |
|----------------------|--|

- | | |
|------------------|---|
| | Process |
| Procedure | <ol style="list-style-type: none"> 1. Make sure that there is no overlap between the IP addresses of the router and the corporate network. 2. In case of an overlap, change the IP address range of the router. 3. Use the patch cable to connect the router WAN port to the company network. 4. Restart all devices, including the computer. |

- | | |
|---------------|---|
| Result | <ul style="list-style-type: none"> ■ The LAN is now integrated into the company network. |
|---------------|---|

5.7.6 Controlling several systems separately in a LAN

Devices connected to a LAN communicate through ports, which are part of the IP address. If more than one chromatography system is connected to the same LAN and you plan on controlling them separately, you can use different ports to avoid interference. Therefore, the port number for each device has to be changed and this same number has to be entered into the device configuration of the chromatography software. We recommend to use the same port number for all devices in the same system.



Note: The port is set to 10001 at the factory. Use the same numbers in the device configuration of the chromatography software as in the device, otherwise the connection fails.

Process

Procedure

1. Find out port number and change it on the device.
2. Enter the port number in the chromatography software.

Result

- The connection has been established.

5.7.7 Remote control

On the rear panel of the single devices an electrical connector socket is located which serves to send or receive signals from other devices. For example start signals from an injection valve or an autosampler can be put to the START input. All voltages have to be mounted between GROUND and the corresponding event.

NOTICE

Electronic defect

Electrostatic discharge can destroy the electronics.

→ Wear a protective bracelet against electrostatic discharge and ground.

For test purposes or in some other cases, it can make sense to enter these signals manually.

- Sending control signals (Events) to external devices
- Opening and closing contacts
- Activating 500 ms pulses

The following remote signals can be received and sent:

- For receiving start, control, and error signals from external devices
- For sending start, control and error signals to external devices



Note: For the specific relation between display and terminal strip, refer to the instructions of the device.

5.7.8 Connecting the pin header

To control one device through another, the pin header is used. To use remote control, you have to connect cables to the pin header. The single ports are used to exchange control signals.

- Prerequisites**
- The device is switched off.
 - The power plug is disconnected from the device.
- Tools**
- Depressor tool

NOTICE

Electronic defect

Connecting cables to the multi-pin connector of a switched on device causes a short circuit.

- ➔ Turn off the device before connecting cables.
- ➔ Pull the power plug.

NOTICE

Electronic defect

Electrostatic discharge can destroy the electronics.

- ➔ Wear a protective bracelet against electrostatic discharge and ground.

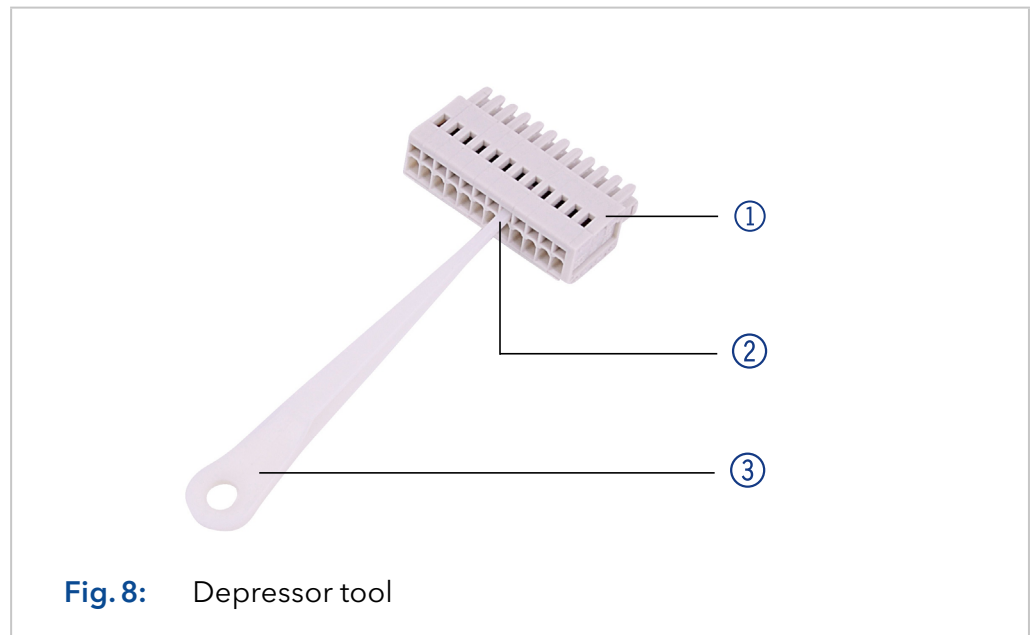

Fig. 8: Depressor tool

Process

1. Insert the depressor tool ③ in an upper small opening at the front of the pin header ① .
2. Insert the cable into the opening ② underneath the inserted depressor tool.
3. Pull out the depressor tool.

Next steps

- Check whether the cables are tightly attached.
- Press the pin header onto the connector.
- Finish the installation.
- Bring the device into operation.

6. Start-up

6.1 Initial start-up checklist

NOTICE

Device defect

Changes of the ambient temperature cause condensation inside the device.

→ Allow device to acclimate for 3 h before connecting to power supply and taking into operation.

Use this checklist to determine if the system is ready for initial start-up:

- Devices are positioned in the correct location.
- The power plugs are connected.
- The network connection to the router is established
- The chromatography software has been installed by KNAUER or a company authorized by KNAUER.
- The capillaries are connected.

6.2 SOP: SMB power-up and shut-down

6.2.1 Power-up

If the assistants are connected via Error in/out, follow this procedure to power up the AZURA® SMB system.

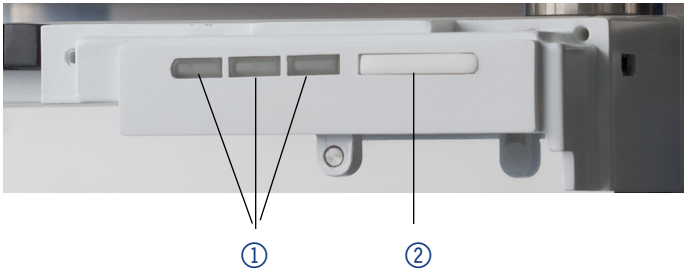
Step	Task
1	Power up the router and wait until the self-test is performed.
2	Power up all instruments and the PC.
3	Shortly press the switch (see picture below no. ②) to deactivate the error message (red flashing of the left LED see picture no. ①) of the assistants.
	<div style="display: flex; align-items: center;"> <div style="margin-right: 10px;">  </div> <div> <p>Note: The red flashing is a normal behaviour and a safety feature, that indicates if one assistant has no power, the other assistants show an error warning.</p> </div> </div>
	
4	If a user management is used on the PC, login with the correct credentials.

Step	Task
5	Start the PurityChrom® software with double click on the desktop icon.

If the assistants are NOT connected via Error in/out, follow this procedure to power up the SMB.

Step	Task
1	Power up the router and wait until the self-test is performed.
2	Power up all instruments and the PC.
3	If a user management is used on the PC, login with the correct credentials.
4	Start the PurityChrom® software with double click on the desktop icon.

6.2.2 Shut down

Follow this procedure to perform an AZURA® SMB shut down.

Step	Task
1	Close the software PurityChrom®.
2	Power up the PC.
3	Turn off all instruments.
	 Note: If the assistants are connected via Error in/out, after shutting one assistant down, the other assistants will show an error message by a red flashing of the left LED. This behaviour is normal and a security feature.
4	Turn off the router.

6.3 SOP: SMB start-up

Follow this procedure to perform an AZURA® SMB system start-up.

Prerequisite ■ Ensure that the eluents are HPLC quality and are filtered by 0.45 µm filter.

In the main flow scheme, only active lines in start position between column loop and multi-position lines are shown. Each connection on the multi-port valves up- and downstream of the pumps is connected to the related connection port between the columns as shown in the figure.

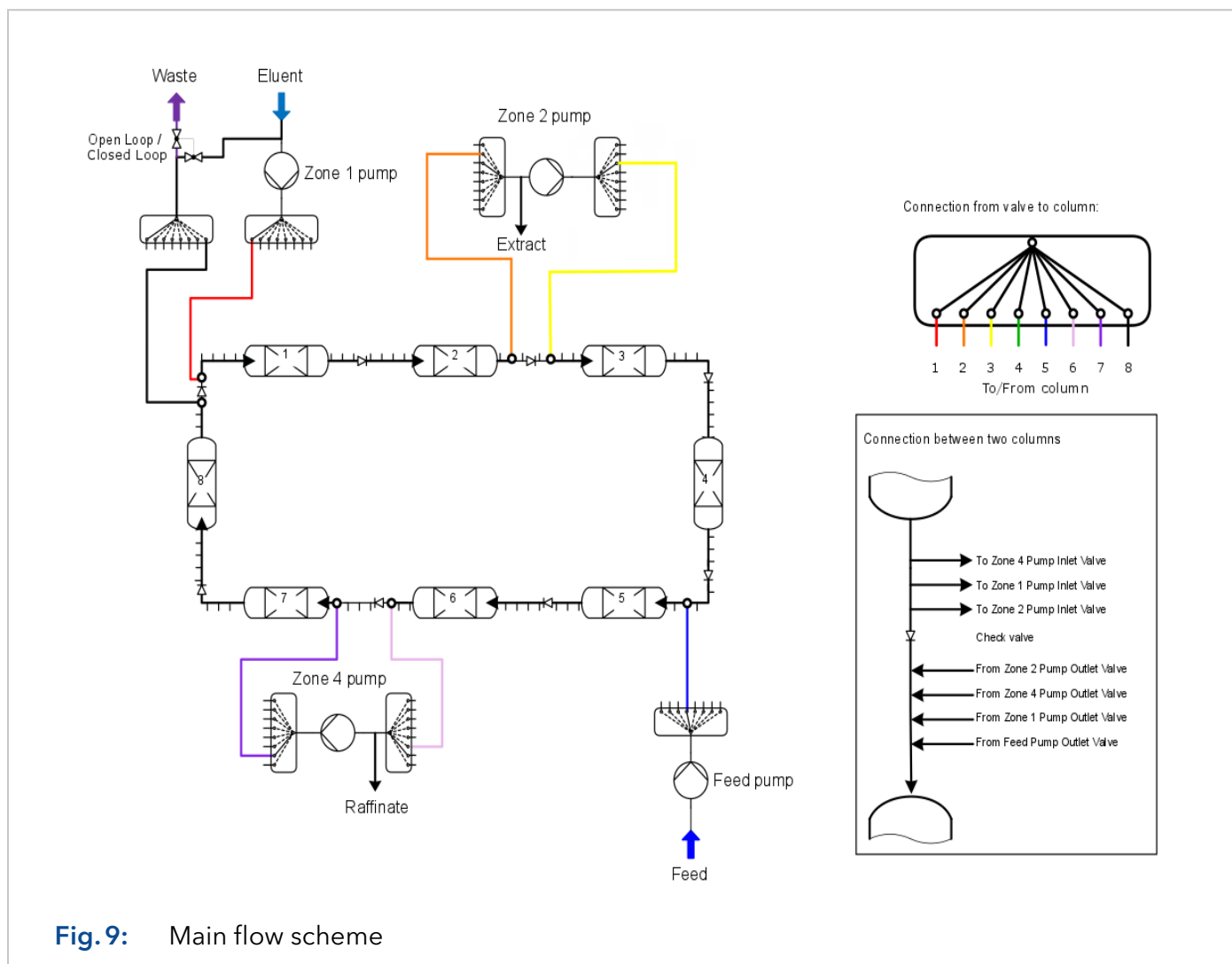

The SOP removes air and impurities from the system. In addition, the cleaning of columns is possible.

The system has to be flushed/cleaned stepwise from Zone 1 to Zone 2, from Zone 2 and 3 to Zone 4 and from Zone 4 to waste.



Note: High flow rates will generate high backpressure. Do not try to flush the system with the highest possible flow rate.

6.3.1 Preparation

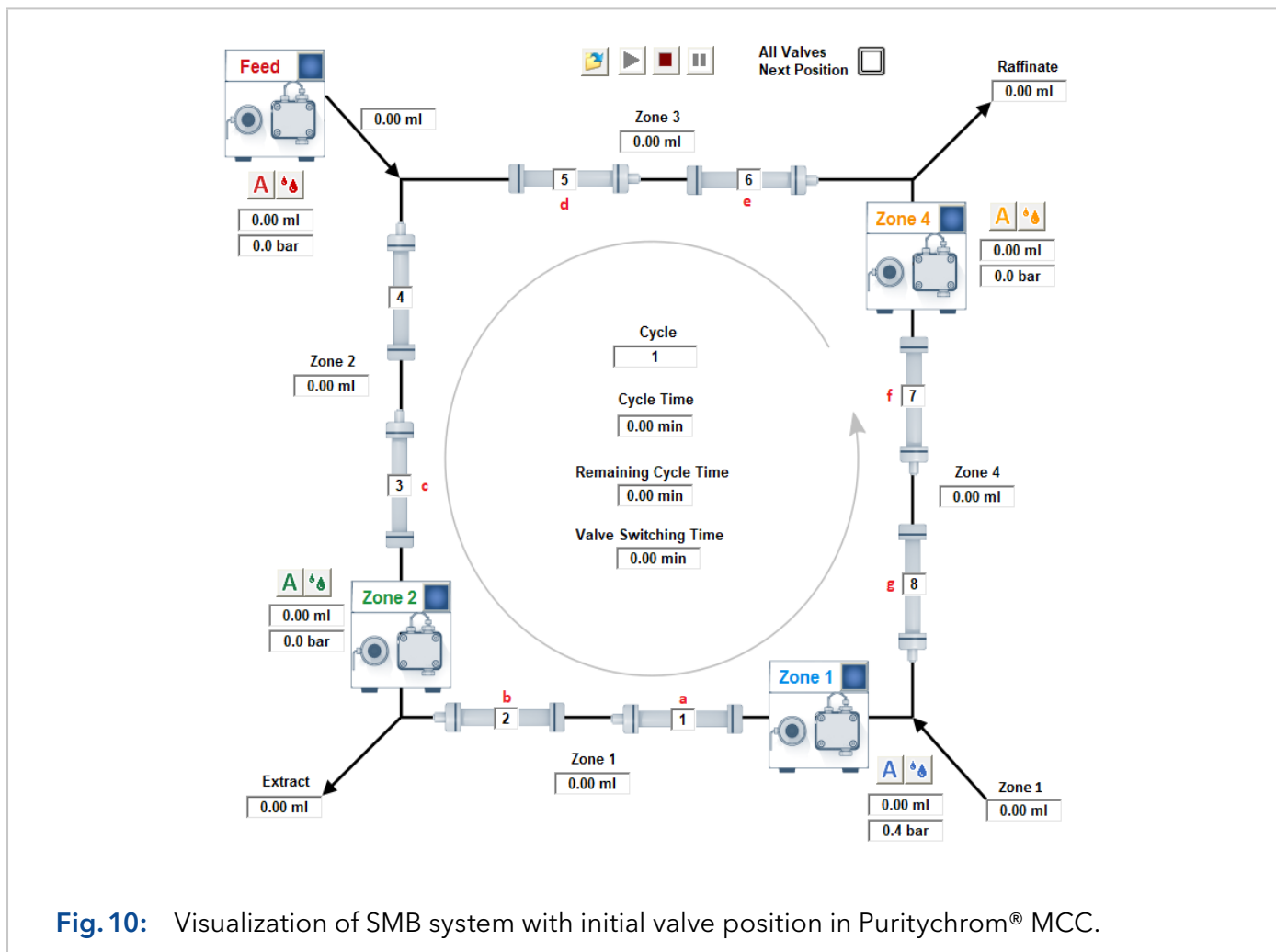



Fig. 10: Visualization of SMB system with initial valve position in Puritychrom® MCC.



Step	Task
1	"Loop valve" is in position "Open Loop". Otherwise the air/contamination will be transferred continuously through the SMB.
2	Set the valves (default values): <ol style="list-style-type: none"> pump "Zone 1 out" to 1 pump "Zone 2 in" to 2 pump "Zone 2 out" to 3 pump "Feed out" to 5 pump "Zone 4 in" to 6 pump "Zone 4 out" to 7 pump "Zone 1 in" to 8
3	Open the purge valve of Zone 1 pump and connect it to a syringe.
4	Set the flow rate at 10 % of the pump heads max. flow.
5	Suck eluent through the pump.
6	When no more air bubbles are visible in the inlet tubing, stop the pump and close the purge valve.

6.3.2 Flushing the system



Note: For flushing the system without column, proceed here. For cleaning the whole system including columns, go to chapter "Flushing all columns".

Step	Task
1	For the Zone 1 pump, set the flow rate at 25 % of the pump heads max. flow.
2	Wait until there is a stable flow rate exiting the extract line and no more air bubbles are visible in the extract outlet. A slow dripping out of the raffinate line can occur. <div style="border: 1px solid black; padding: 5px; margin-top: 10px;"> <p>Note: If the eluent is mainly exiting the raffinate or waste line, proceed with step 3 and 4. Afterwards continue with step 2. If the eluent is still mainly exiting the raffinate or waste line, check the valve positions, flow rates, purge valves and external check valves.</p> </div>
3	Switch all valves to the next position (Valve Control: All Valves, Next Position -> Set)
	
	Wait until no air bubbles leave the extract.
4	Repeat step 3 until you reach the initial valve position.
5	Connect a syringe to the purge valve of the Zone 2 pump and open the purge valve.
6	For the Zone 2 pump, set the flow rate at 15 % of the pump heads max. flow.
7	Suck the eluent through the pump and wait until no more air bubbles leave the pump.
8	Close the purge valve.
9	Wait until there is a stable flow rate exiting the raffinate line and no more air bubbles are visible in the raffinate outlet. A slow dripping out of the waste line can occur. <div style="border: 1px solid black; padding: 5px; margin-top: 10px;"> <p>Note: The flow rate in raffinate should be higher than in extract, otherwise check the valve positions, flow rates, purge valves and external check valves.</p> </div> <p>Ensure that the pumps have been flushed sufficiently. If not, repeat the procedure from step 1.</p>
10	Connect a syringe to the purge valve of the Feed pump and open the purge valve.
11	For the Feed pump, set the flow rate at 25 % of the pump heads max. flow.
12	Suck the eluent through the pump and wait until no more air bubbles leave the pump.
13	Close the purge valve.



Step	Task
14	<p>Wait until there is a stable flow rate exiting the raffinate line and no more air bubbles are visible in the raffinate outlet. A slow dripping out of the waste line can occur.</p> <p> Note: The flow rate in raffinate should be higher than in extract, otherwise check the valve positions, flow rates, purge valves and external check valves.</p> <p>Ensure that the pumps were flushed sufficiently. If not, repeat the procedure from step 10.</p>
15	Connect a syringe to the purge valve of the "Zone 4 pump" and open the purge valve.
16	For the Zone 4 pump, set the flow rate at 10 % of the pump heads max. flow.
17	Suck the eluent through the pump and wait until no more air bubbles leave the pump.
18	Close the purge valve.
19	The "extract" flow should now be equal to the "raffinate" flow. Otherwise, check the valve positions, flow rates, all purge valves and external check valves.
20	Wait until there is a stable flow rate exiting the waste line and until no more air exits the system through the waste tubing plus additional 30 min.
21	<p>Switch all valves to the next position (Valve Control: All Valves, Next Position -> Set)</p>  <p>Wait until no air bubbles leave the extract, raffinate and waste outlet.</p>
22	Repeat step 21 until you reach the initial valve position.

6.3.3 Washing one single column

Prerequisite ■ Check if the correct washing solvent is connected to the eluent inlet.



Note: The back pressure caused by the specific columns may be too high with the recommended flow rates in the SOP. Reduce the flow rates for each pump in the same ratios to reach moderate pressure values (~ < 50 % of p max.).

Step	Task
1	Set the "Loop valve" in position "Open Loop". Otherwise the air/contamination will be transferred continuously through the SMB.
2	Set the valves "pump Zone 1 out" and "pump Zone 1 in" to the number of the column you want to clean up. Set every other column to +4 positions in comparison of the "washing column". e.g.: washing of column 1 a. pump "Zone 1 out" to 1 b. pump "Zone 2 in" to 5 c. pump "Zone 2 out" to 5 d. pump "Feed out" to 5 e. pump "Zone 4 in" to 5 f. pump "Zone 4 out" to 5 g. pump "Zone 1 in" to 1
3	Open the purge valve of Zone 1 pump and connect it to a syringe.
4	For Zone 1 pump, set the flow rate at 10 % of the pump heads max. flow.
5	Suck eluent through the pump.
6	When no more air bubbles are visible in the inlet tubing, stop the pump and close the purge valve.
7	For Zone 1 pump, set the flow rate at 20 % of the pump heads max. flow.
8	Wait until a stable flow in the waste channel.
9	Wash the column with at least ten column volumes.  Note: It might be necessary to use more eluent to clean the columns or to change the eluent, to get the impurities removed.
10	Stop the pump.  Note: Skip the next two steps, if the columns have been washed with the SMB eluent.
11	Change the eluent to the eluent used in the SMB process.
12	Start the pump and flush the column with at least 5 column volumes.

6.3.4 Flushing all columns



Note: If you want to flush your columns with a new solvent, run the procedure "Flushing the system" with five column volumes (whole column volume!).



Note: The back pressure caused by the specific columns may be too high with the recommended flow rates in the SOP. Reduce the flow rates for each pump in the same ratios to reach moderate pressure values (~ < 50 % of p max.).

6.3.5 Washing all columns



Note: If you want to wash your columns, run the procedure "Flushing the system" with ten column volumes (whole column volume!).



Note: The back pressure caused by the specific columns may be too high with the recommended flow rates in the SOP. Reduce the flow rates for each pump in the same ratios to reach moderate pressure values (~ < 50 % of p max.).

7. Simulated Moving Bed principle

7.1 Introduction

Due to the fast development of new compounds and the more precise knowledge about them, there is an increasing demand for purified products. In most cases, chemical syntheses produce a lot of side components. Therefore, different separation steps have to be involved into production processes.

The most established and theoretically described thermal separation processes (e.g. distillation, extraction, crystallization etc.) can not be applied to all separation tasks. Among new separation methods, the adsorption chromatography is a very effective but expensive process. The principle of adsorption chromatography was discovered in the last century. The separation is caused by different affinities of the compounds (dissolved in a liquid) to a useful solid phase.

Applications of adsorption chromatography were limited to analytical scale for a long time. In the analytical scale, the mixtures are very diluted and the distribution of a component between liquid and the solid phase can be described by linear relations.

In the last few decades, adsorption chromatography is more and more applied to the preparative process scale, where higher concentrations are used and the liquid-solid distribution of a component becomes non-linear and concentrationdependent. The peak profile and the retention times are changing, so that modeling is more complicated.

The most established chromatographic process mode is elution chromatography. Due to the theoretical understanding of this mode, it is possible to use it in a very large scale. The regime of elution chromatography is a discontinuous one, i.e. only discrete amounts of a mixture can be separated. For higher amounts, a continuous mode should be favored. For a binary (or pseudo-binary) mixture, the SMB process (Simulated Moving Bed) with conventional chromatographic columns is successful.

Only the general principles of SMB will be explained in these instructions.

7.2 Elution chromatography

Among the established industrial scale separation processes preparative adsorption chromatography is more and more used. Some separation task (e.g. the separation of enantiomers) can be solved only by chromatography. The basic principle of elution chromatography is shown in Fig. 11.

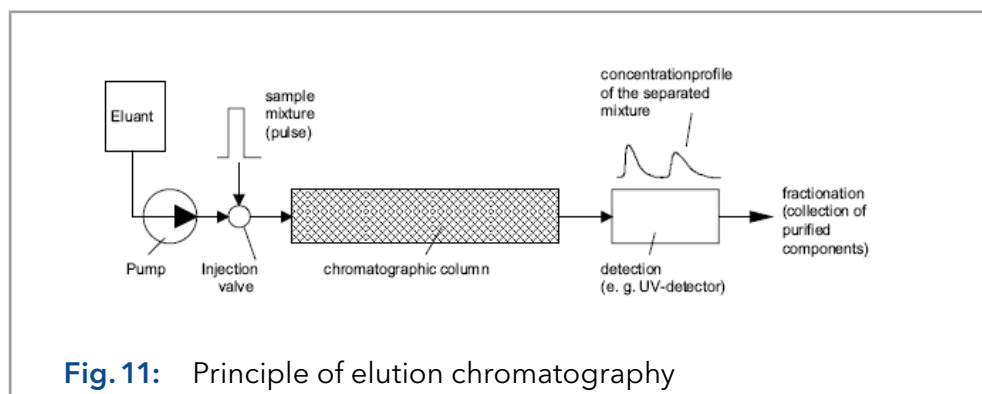

The chromatographic column packed with a solid phase (adsorbent) will be permanently penetrated by a fluid phase (eluent) with a well defined interstitial velocity. At the time t_0 a well defined amount of the sample mixture is injected into the column. Due to different interaction forces of the mixture components and the adsorbent (different migration velocities), a separation of the mixture into the pure components will take place. At the column outlet the purified components can be detected and collected. This is the general principle of chromatography.

In preparative chromatography, the column is highly overloaded and is not sufficient to completely separate the mixture into the pure components. The peaks are overlapping. This is shown in Fig. 12. An unspecific detector would show only the sum of both components, while the single components are detectable in combination with a specific detector.

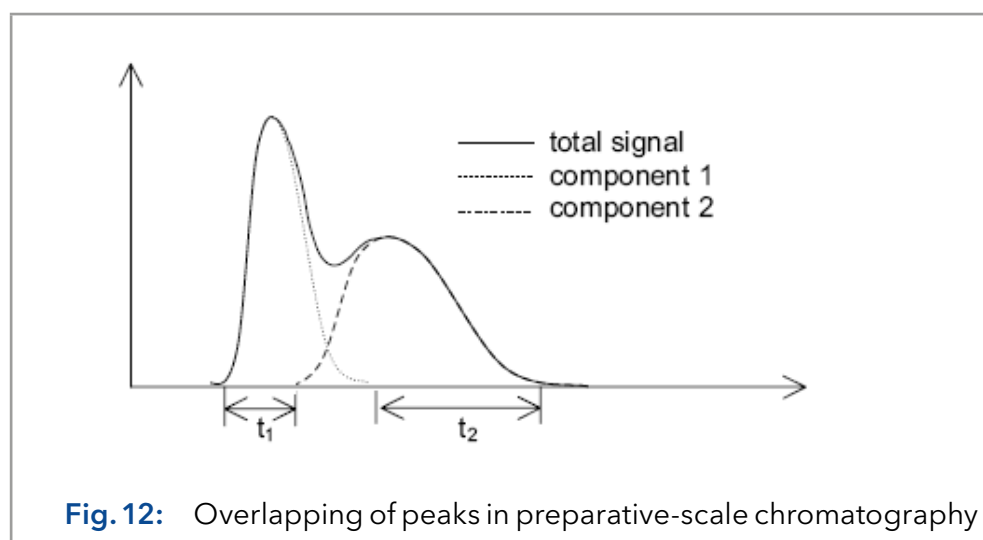

Fig. 12: Overlapping of peaks in preparative-scale chromatography

The reason for overloading the column is, that there are time sections (t_1 , t_2), where the components elute in the required purity with a high concentration. Because of the higher concentrations smaller liquid volumes are necessary to separate equal amounts of the sample, such that the separation of the value added components from the eluent (e.g. in vacuum evaporators) is much simpler and cheaper.

The overlapping part of the concentration profile shown in Fig. 12 with a lower purity than required can be recycled to the column inlet.

In elution chromatography pulses are injected into the column, which are separated in time (left side of Fig. 13).

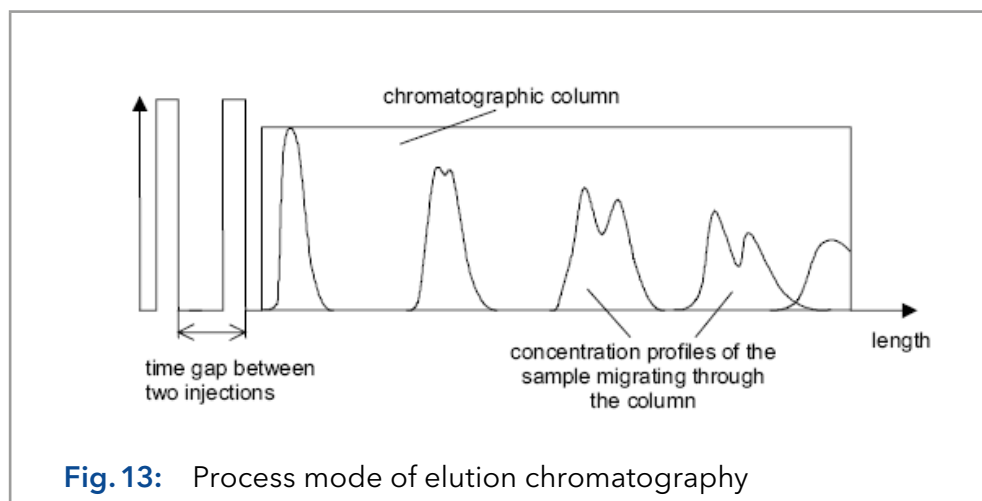

Fig. 13: Process mode of elution chromatography

While migrating through the column, these pulses are broadened, due to axial dispersion and different migration velocities and they are separated into the pure components due to different interaction forces to the adsorbent.

The time between two pulses i and $i+1$ have to be chosen in such a case, that the slowest component of pulse i elutes before the fastest component of pulse $i+1$ or just before they overlap too much, where pulse i is injected before pulse $i+1$ (Fig. 13).

If you would separate the column into small sections, there are parts with two or more components within. Here and only here, the separation process takes place. In other sections there is only pure eluent and the separation capacity of the solid is not used. At the transients between these and the sections containing the components dilution and mixing are taking place. If two peaks are overlapping, because of different migration velocities, there is also mixing.

In the last described sections no separation takes place. These parts causes a lower use of the adsorbent capacity, but can not be avoided in elution chromatography. This is because of the discontinuous or batch regime of the process, i.e. only discrete amounts of the mixture can be injected. Increasing the scale of the column, increases the total amount, but it does not change the discontinuous character, connected with the lower use of the adsorbent capacity and dilution effects.

To separate larger amounts with smaller columns, other process modes than elution have to be used either a true counter-current process or a simulated one.

7.3 True counter-current process

By contacting an up-flowing liquid with a down-flowing solid in a separation column, a true counter-current chromatographic process is realized, called True Moving Bed (TMB). The TMB was first commercialized in the hypersorption process of the Union Oil Company of California in the early 1950th.

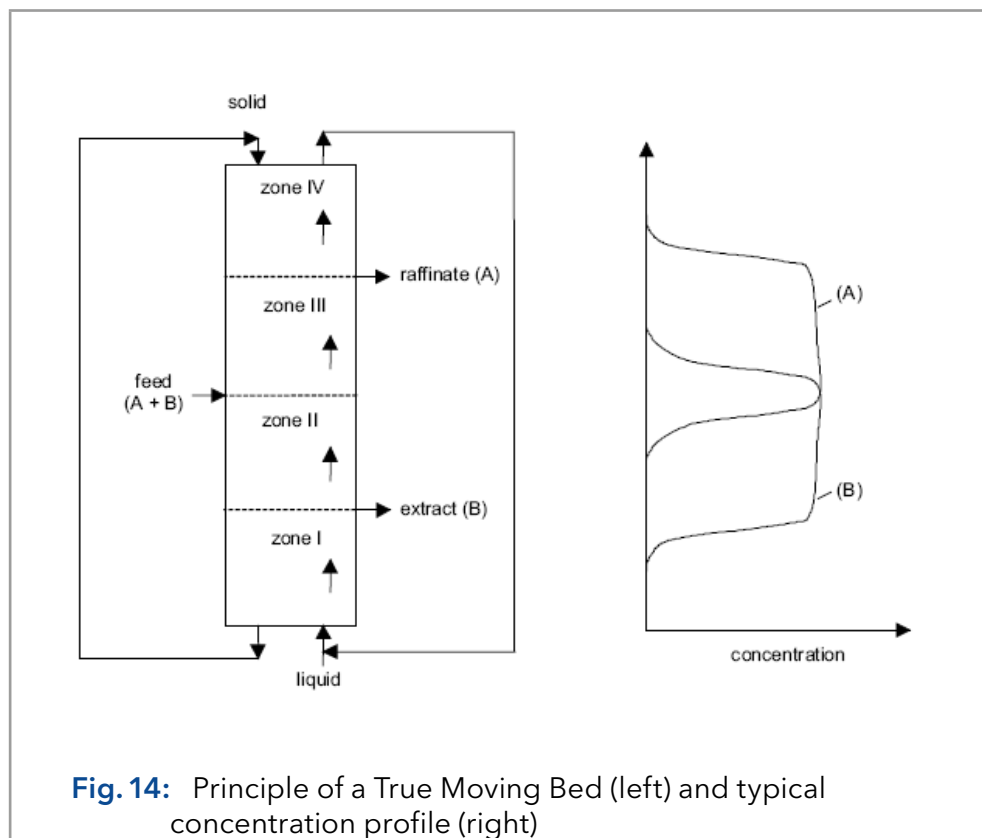

Fig. 14: Principle of a True Moving Bed (left) and typical concentration profile (right)

Unloaded solid (adsorbent) is continuously filled into the upper end of the column, while liquid (eluent) is pumped into the lower one. The binary (or pseudo-binary) feed-mixture is continuously injected in the middle of the column. To separate the components of the mixture, they have to be differently adsorbed on the solid.

The two feed components are called A and B, where A is the less and B the more adsorbed component, respectively. If there is a suitable ratio between the volumetric flow rates of the solid and the liquid phase, component B is adsorbed on the solid and is flowing downwards, while component A is displaced from the solid and is transported upward by the liquid. Pure component B can be withdrawn in the lower and pure A in the upper part of the column. The TMB process is able to separate binary or pseudo-binary mixtures into the two parts, where one part contains the less adsorbed compound, while the more adsorbed compound is in the other one. To achieve more than two fractions, difficult changes are necessary.

The separation column can be divided into four zones or sections shown in Fig. 14. These zones are fulfilling different functions.

Injecting a well defined volumetric flow rate with a well defined concentration of feed into an initially unloaded column at time t_0 all species are transported into zone III. Following the laws of adsorption, the components of the mixture will be distributed between the liquid and the solid phase. The more adsorbed component will be enriched in the solid phase.

Since a high purity of component A is required in the raffinate stream, component B has to be adsorbed in section III in the volume between feed inlet and raffinate outlet. Therefore, the function of zone III is to adsorb component B or to separate it from A, respectively. The inverse problem exists in section II, where component A has to be desorbed from the solid phase and to be pushed back into zone III. Section II has the function to separate component A from B.

Zone I has to clean the solid. All components flowing into this section have to be desorbed, so that only the unloaded solid reaches the lower end of the column and is recycled to the upper end. In zone IV, vice versa, the liquid has to be cleaned. Recycling the pure liquid to the lower end of the column, decreases the desorbent or eluent consumption. Condensed, there are two separation sections (zone II and III) and two cleaning sections (zone I and IV).

If you realize a suitable ratio of the volumetric flow rates of the liquid and the solid phase in each zone, a concentration profile like that sketched on the right side in Fig. 14 is created. The raffinate stream contains nearly no B and the extract stream nearly no A. The most important parameters for properly designing a TMB unit are the volumetric flow rates of the liquid and the solid phase.

The true counter-current chromatographic process has the main drawback that the solid transport is difficult to realize due to back-mixing of the adsorbent particles. Another important point is, that only small flow rates are possible, since otherwise the solid would be pushed back by the liquid. So the separation performance of the process is decreased.

To avoid these problems, different attempts have been made, however they shall not be explained in detail here. The probably best possibility to avoid the TMB drawbacks is explained now.

7.4 Simulated counter-current process

The simulated counter-current process (Simulated Moving Bed - SMB) was developed in the early 60th by the Universal Oil Products Company. It was mainly applied to industrial-scale separations, like the xylene separation or the fructose-glucose separation. The process scheme is shown in Fig. 15.

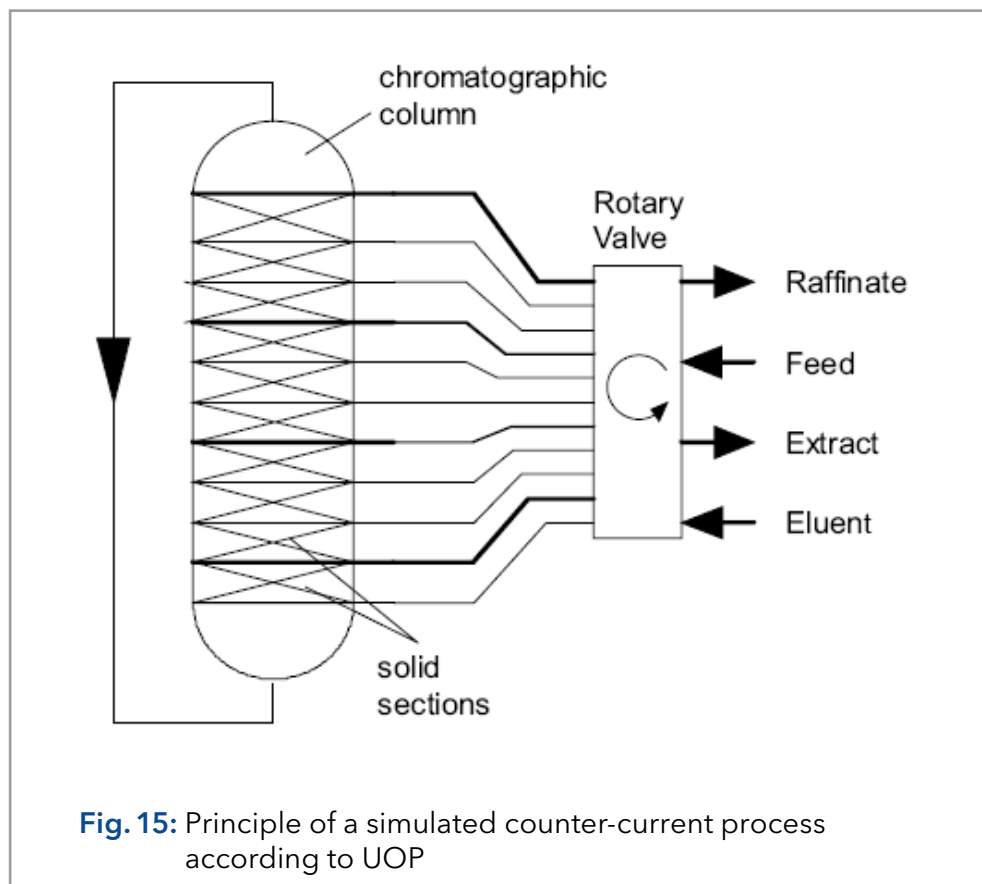

There is a strong analogy between the SMB and the TMB process. Under the use of a suitable system of adsorbent and eluent, a feed stream is separated into two withdrawal streams containing the pure components of a binary or pseudo-binary mixture.

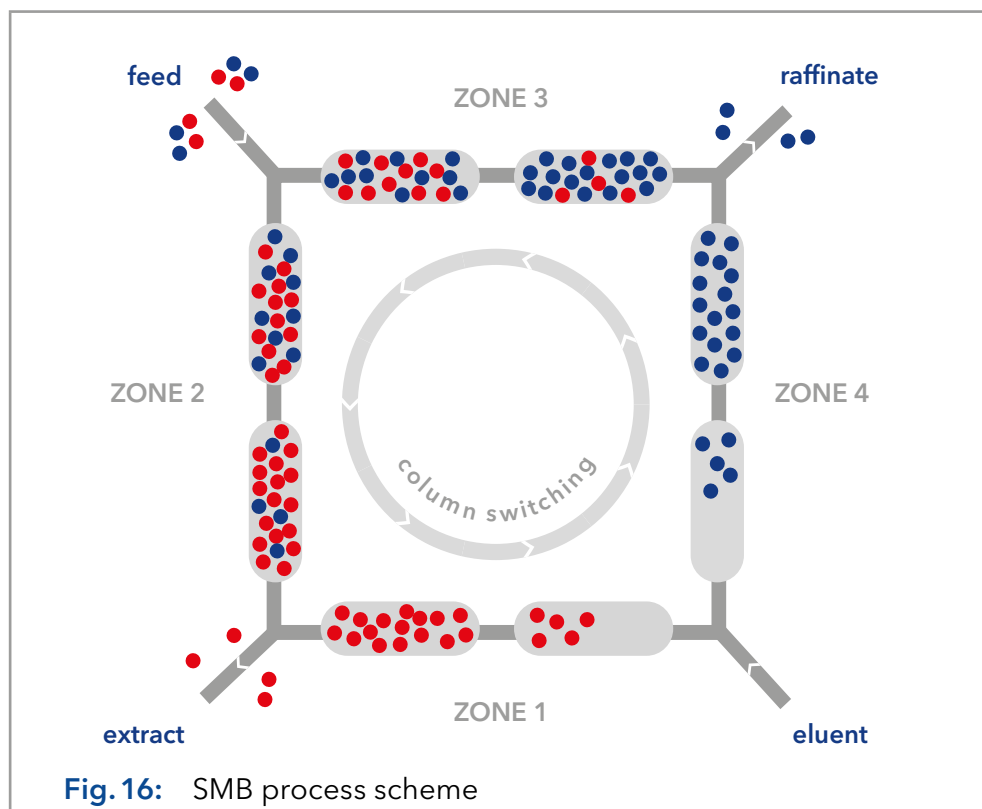

For SMB applications the large column in Fig. 15 can also be substituted by a number of chromatographic columns. This is sketched for 8 columns in Fig. 16. Like in the TMB process there are feed, eluent, extract and raffinate inlets and outlets, dividing the circle of columns into four sections. In Fig. 16 the columns are distributed symmetrically, i.e. there are equal numbers of columns in each section.

Special valves allow the liquid to flow in only one direction. The inlets and outlets are arranged in a pre-defined manner and are switched in the same direction as the fluid flows.

The switching time T^{Shift} can be achieved from the volumetric flow rate of the solid and the solid volume.

$$T^{\text{shift}} = \frac{V_{\text{solid}}}{\dot{V}_s}$$

Where V_{Solid} is the solid volume and \dot{V}_s the volumetric flow rate of the phase. The counter-current stream is only realized at the switching.

Otherwise the columns are only a serial connection of conventional fixed beds. The necessary switches of a column to reach its initial position is called a cycle. Due to the discrete switching mode, there is no stationary but only a cyclic steady state in SMB technology.

The four sections of the SMB fulfil the same functions as in the TMB process, i.e. in the zones II and III the binary mixture is separated, and in the zones I and IV the solid and the liquid are cleaned, respectively. There are the same requirements in length or number of columns as in TMB.

Because of the desorption the extract-concentration is decreased and the breakthrough causes an increasing concentration in the raffinate at each switching interval. Typical concentration profiles of both outlets for a 4-column SMB configuration are shown in Fig. 17.

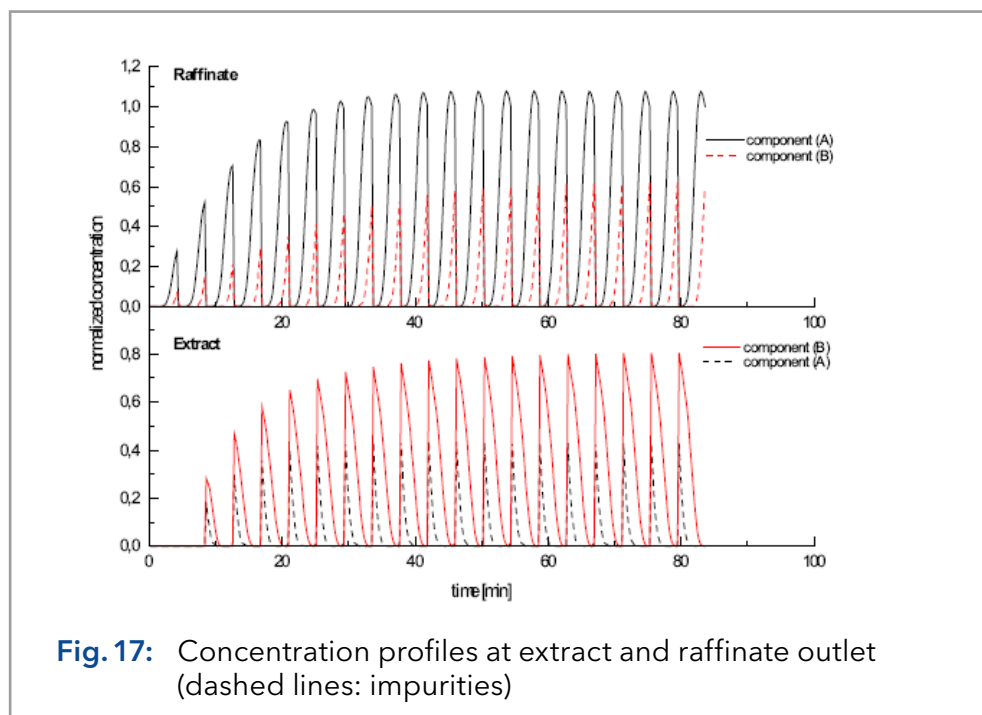

Fig. 17: Concentration profiles at extract and raffinate outlet (dashed lines: impurities)

In Fig. 17 the concentrations are normalized on the feed concentration of each component. These normalized concentrations are plotted versus the time coordinate. There are typical zigzag profiles, where a triangle symbolizes one switching interval or tact. After 12 of these intervals (i.e. 3 full cycles for a four column SMB process) the cyclic steady state is reached (two proceeding triangles are almost identical). By integrating the profiles over the time range, the averaged concentration can be calculated, i.e. the concentration measured in a vessel.

Since only four columns (minimal number) are supposed in simulating (Fig. 17) the separation performance is low, i.e. there are impurities of the other component in each outlet. Increasing the number or the length of the columns would increase the separation performance.

7.5 Efficiency and economic aspects

Chromatographic separation processes belong to the expensive ones, compared with other thermal separation processes (distillation, crystallization, etc.). This is caused by high prices for the adsorbents (e.g. spherical silica gel in a high quality, chemically modified) and by the pure solvents needed.

Nevertheless, chromatographic processes are very effective. They are suitable for difficult separation problems, where the mixture compounds have very similar physico-chemical properties as well as for the separation of very expensive products. This is fulfilled for many products of the pharmaceutical and fine chemical industry or the food and drug industry. In these industries some compounds are produced, which can only be separated by chromatography.

In the previous chapters, three chromatographic modes were described (elution, TMB, SMB). Out of these modes preparative elution chromatography is theoretically as well as practically the best known one. It has been applied for a long time and creates the standard, at that new methods are measured.

The modes are suitable for preparative scale processes. These scales can be very different ones: While in petrol-chemistry 100,000 metric tons per annum are produced, in the pharmaceutical industry only a few kilograms are produced. From an industrial point of view only elution chromatography and the SMB process are attractive out of the three modes, due to the difficulties connected with the solid movement in TMB.

To compare the two important modes (elution, SMB) in a fair way, the plant scale has to be considered. After optimization of the two modes different optimal points in the multidimensional space of process relevant parameters are reached.

Such parameters are in the elution mode the volumetric flow rate of the eluent, the injected amount of the mixture per pulse, the time gap between two pulses, the produced amounts of purified compound, the column geometry, the properties of the column packing, the required purity, the temperature, etc. In SMB the volumetric flow rates (solid and liquid) in each zone, the number of columns and the column geometry, the produced amounts of purified compounds, the feed and withdrawal concentrations, the properties of the column packing, the required purity, the temperature etc. are relevant. Both modes are suitable for various separation tasks. The specific problem, hence, has to be known for a fair comparison.

The SMB process enables the separation of binary mixtures by means of a simulated countercurrent between the solid and liquid phases. This is accomplished with a series of chromatography columns arranged in a ring. An eluent flow circulates through this ring. Two inlets (for feed and eluent) and two outlets (extract/red and raffinate/blue) define four separation zones. By continuously feeding sample and synchronously switching the columns against the eluent flow direction, a countercurrent is achieved between the solid and liquid phases, leading to high purity of both target fractions. The movement of the solid phase is realized by simultaneously switching seven multi-position valves (AZURA® SMB).

The SMB saves up to 90% of the eluent in comparison to a batch process. Due to the simulated countercurrent, the stationary phase is significantly better utilized with the SMB technique as compared to the batch process technique. The number of theoretical plates might be also less important, making it possible to use cost-effective larger particle size for the stationary phases.

8. Operation

8.1 Software operation

To operate the system with software, you have to establish a connection between the LAN port and a computer. The system can be controlled with Puritychrom® MCC. You find a detailed description on chromatography software in the corresponding software instructions (document no. [V2650](#)).

8.2 Meaning of the LEDs

There are three LEDs and a switch on the front of the devices.

Legend:

- ① Left LED
- ② Center LED
- ③ Right LED
- ④ Switch/Standby button

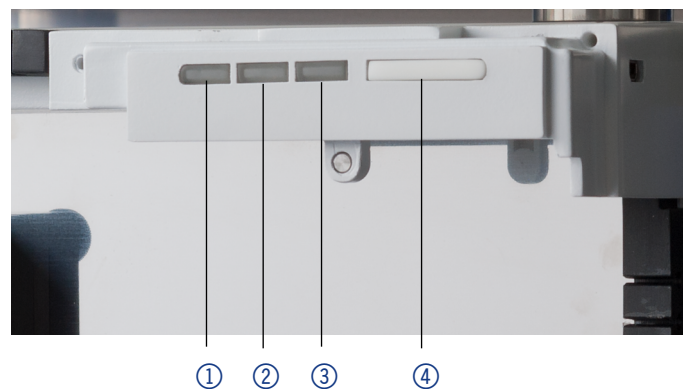

Fig. 18 LEDs and switch/standby button on the front of the device

The LEDs can have different colors depending on the operating conditions.

Standby ■ To start the standby, keep the standby button pressed for 5 seconds.



Note: Malfunctioning system after repeated standby possible. After repeatedly using standby, restart the device using the power switch to reset the device's data storage.

	Color	Status	Operation
Left LED	red	Error	Check the system. Shortly press the switch to deactivate the error message.
	green	3D data are acquired.	
Center LED	does not light	The lamp has been switched off.	
	flashes green	The lamp/lamps are initializing or the validation is progressing.	Wait until the lamp is running or the validation is finished.

	Color	Status	Operation
	green	The deuterium lamp is active.	
Right LED	green	The device has been switched on.	
	flashes green	The device not ready for operation.	Wait until the device is ready for operation.
	blue	The device is in standby.	Press the standby button to end the standby.

8.3 Connecting the columns

Depending on which system you are using, you need to connect the capillaries differently.

8.3.1 AZURA® SMB Lab system

You can integrate up to eight columns in the AZURA® SMB Lab System. Connect the inlet of the column with the capillary coming from the bottom of the capillaries tree and connect the column outlet with a capillary to the top of the capillaries tree. Make sure that the columns relate to the same color coding (see table below). For example, column 1 is connected to both the input and output marked in red.

Color coding columns	Column	Color
	1	Red
	2	Orange
	3	Yellow
	4	Green
	5	Blue
	6	Pink
	7	Purple
	8	Black

Figure 19 shows the direction of flow in the system. The liquid flows upstream through the columns and then downstream through the capillary tree either to the next column or to an outlet.

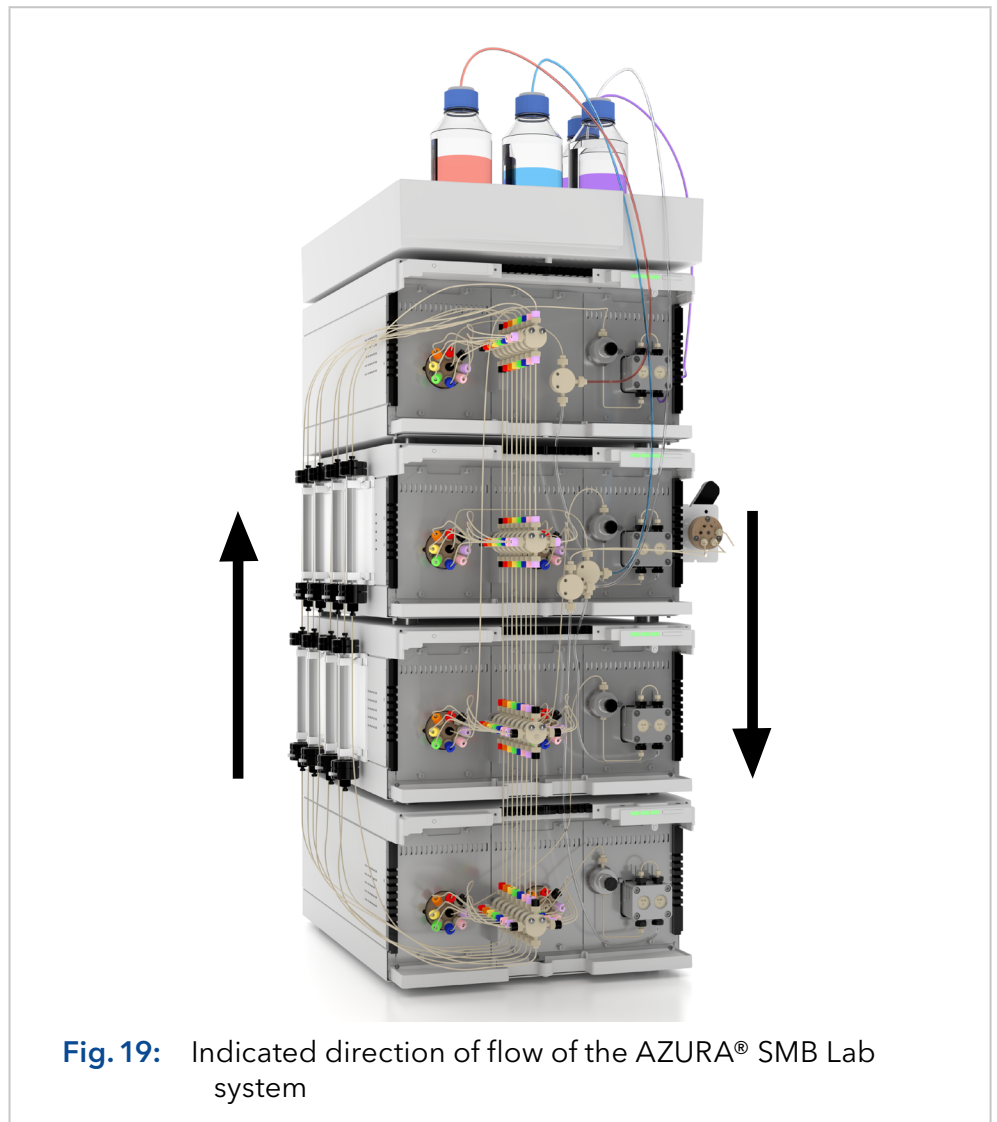

Fig. 19: Indicated direction of flow of the AZURA® SMB Lab system

8.3.2 AZURA® SMB Pilot system

Install the columns of the AZURA® SMB Pilot system on the left side of the system. As shown in Fig. 20, the inlet and outlet ports to the columns are labelled. Because of the additional inline sampling loop, you have to connect the inlet port of column 1 to port 1 of the valve. Connect the other columns according to the numbering.

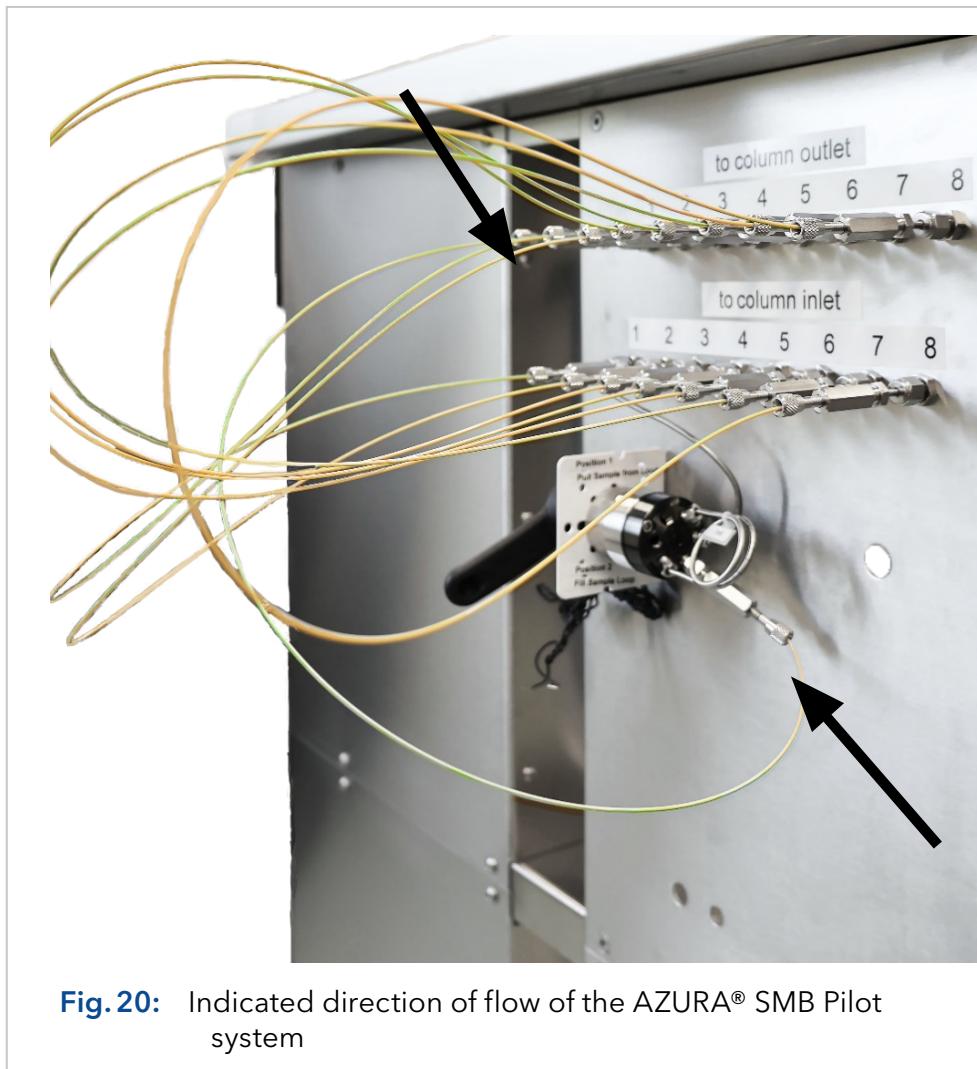

Fig. 20: Indicated direction of flow of the AZURA® SMB Pilot system



8.4 SOP: AZURA® SMB separation

For an overview of the flow scheme, refer to Fig. 16 on page 38.

Prerequisites

- Ensure that the eluents are HPLC quality.
- Ensure that the feed is filtered by 0.45 µm filter.



8.4.1 Preparation

	Step	Task
Procedure	1	<ul style="list-style-type: none"> Perform a preparative separation to determine the SMB parameters. Use the same column type as for the SMB process (dimension and packing material). The columns have to be as similar as possible regarding the test parameters of the quality test (RT, asymmetry, theoretical plates) to guarantee proper results. <p>A separation with an analytical column is also possible. Use an analytical column with the same physical properties of the material as the columns used in the SMB process.</p> <p> Note: We recommend to use a preparative separation with a separation factor between 1.2 and 2 as basis for the SMB process. Values below 1.2 and above 2.0 will decrease the efficiency enormously.</p>
	2	Determine the adsorption type (i.e. linear isotherm) and the adsorption parameters to calculate the SMB parameters.
	3	Transfer the parameters to the current SMB scale, if necessary.
	4	Flush the system first without columns, install the columns and equilibrate the columns inside the system (see chapter „6.3.2 Flushing the system“ on page 28).
		<p> Note: In case of massive contamination inside the system, the system has to be washed without columns. It may be necessary to use back pressure capillaries.</p>
5	Insert the SMB parameter into the software.	
	<p> Note: In case of a linear adsorption, you can calculate the SMB parameter directly in the software (some system information are required).</p>	

8.4.2 Starting the system

	Step	Task
Procedure	1	<ul style="list-style-type: none"> Connect the Feed pump with the eluent tray. Ensure there is no contamination of the eluent with remaining feed at the tubing. “Purge” the pump with eluent by using a syringe.
	2	Wait until the temperature is already equilibrated.
	3	Start the system with the calculated parameters.
	4	Check for leakage and proper work of pumps and flowmeter.
	5	Check dripping at the Extract and Raffinate outlets.

8.4.3 Pausing the separation

	Step	Task
Procedure	1	If required, the SMB system can be paused at any time by clicking the pause button ().
	2	The time will be paused, and all pumps will stop. The valves do not switch anymore.
	3	To restart the separation, click the play button ().

Improving the productivity

The productivity can be improved using the following methods:

- Increasing the feed concentration



Note: May cause impurity in raffinate or extract, see below "Contamination of raffinate in extract".

- Increasing the feed flow



Note: May cause impurity in raffinate or extract, see below "Contamination of raffinate in extract". Can destabilize the SMB process, new process optimization might be necessary.

- Optimizing the SMB parameter

Contamination

Contamination of raffinate in extract

Contamination due to zone IV:

1. Open the eluent recycling valve and check on an analytical instrument if there is any contamination of raffinate in the waste.
2. If there is a contamination, decrease the flowrate in zone IV, otherwise proceed.

Contamination due to zone II:

- Increase the flow rate in zone II to eliminate the raffinate component from this zone.

Contamination of extract in raffinate

Contamination due to zone IV:

1. Open the eluent recycling valve and check if there is any contamination of extract in the waste.
2. If there is a contamination, increase the flow rate in zone I.

Contamination due to zone II:

1. Decrease the flow rate in zone II to prevent that the extract will contaminate the raffinate component here.



Note: After changing parameters, the effect will be shown up to three cycles later.

2. Analyze after each cycle.

8.4.4 Stopping the separation

	Step	Task
Procedure	1	Stop the data collecting.
	2	Clean the system: Use the SOP "SMB start-up" (see chapter „6.3 SOP: SMB start-up" on page 26).
	3	Stop the heater (if possible/necessary).

8.5 Change Zone configurations

8.5.1 From 2:2:2:2 to 1:3:3:1

This section describes the change of the zone configuration to 1:3:3:1 (see table below).

	Zone	Columns per zone
Zone configuration 1:3:3:1	1	1
	2	3
	3	3
	4	1



Note: For a customized SMB set-up with, e.g., flowmeters and detectors, the visualization has to be adapted.

Step	Task
------	------

- Procedure 1** Open the Purity Chrom® MCC setup by clicking .

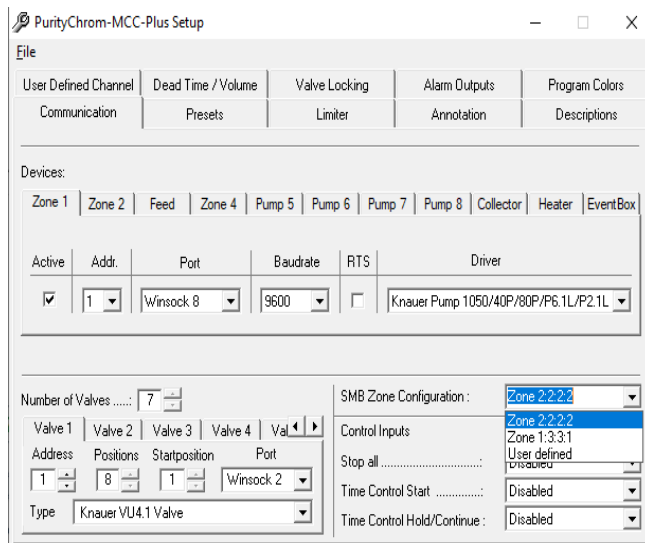

- 2** Select the SMB Zone Configuration in the tab Communication.

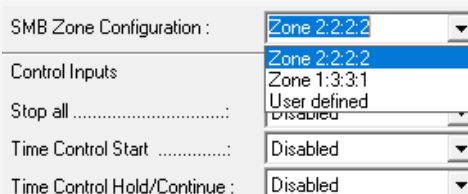

- 3** Choose between Zone 2:2:2:2, 1:3:3:1 or User defined configuration. An individual visualization is loaded automatically for each configuration.

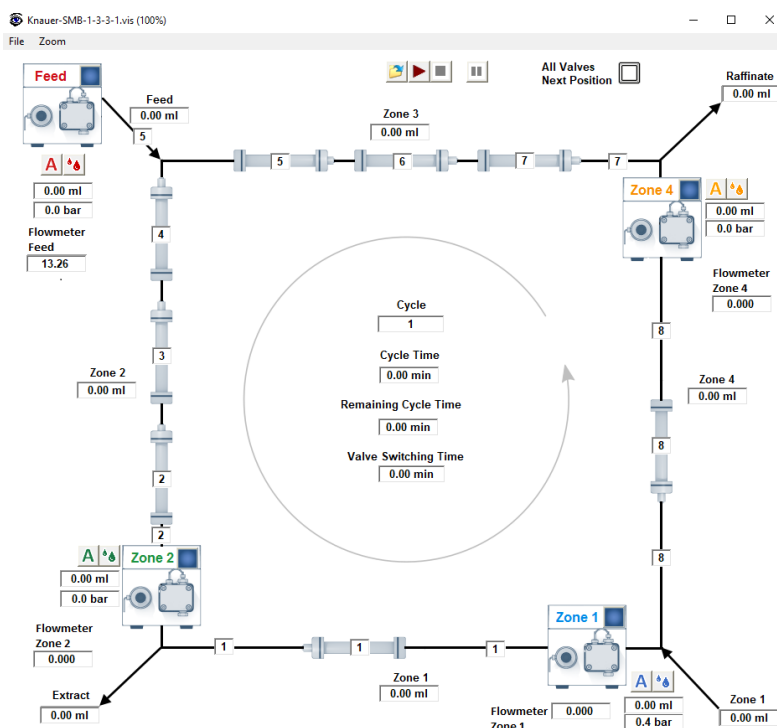

- 4** Close and save the setup.

8.5.2 User defined configuration

As mentioned in the previous section, the configuration can also be changed to user defined. In the visualization, a valve position can be assigned to each position.

Step	Task
------	------

Procedure	1	Open the visualization by clicking  .
-----------	---	--

2	Right-click on the column symbol to select the valve position.
---	--

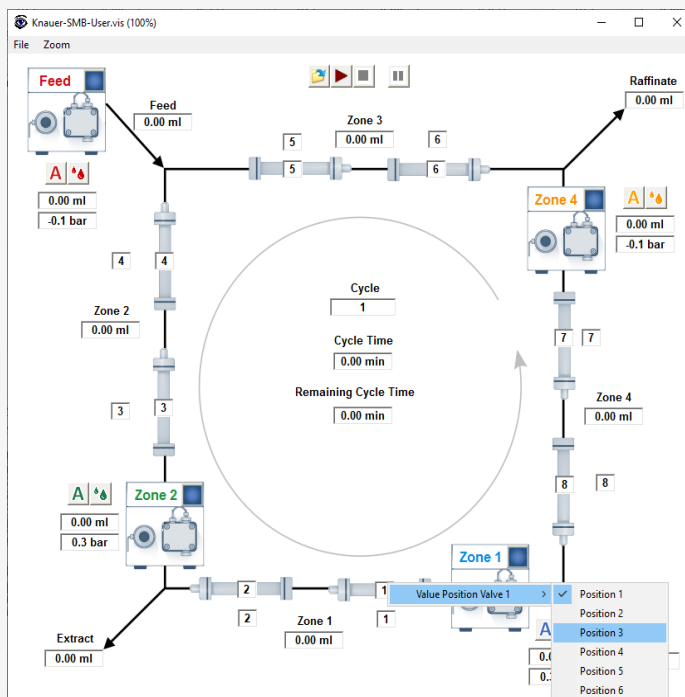

3	Select your valve position. The column number changes depending on your selection.
---	--

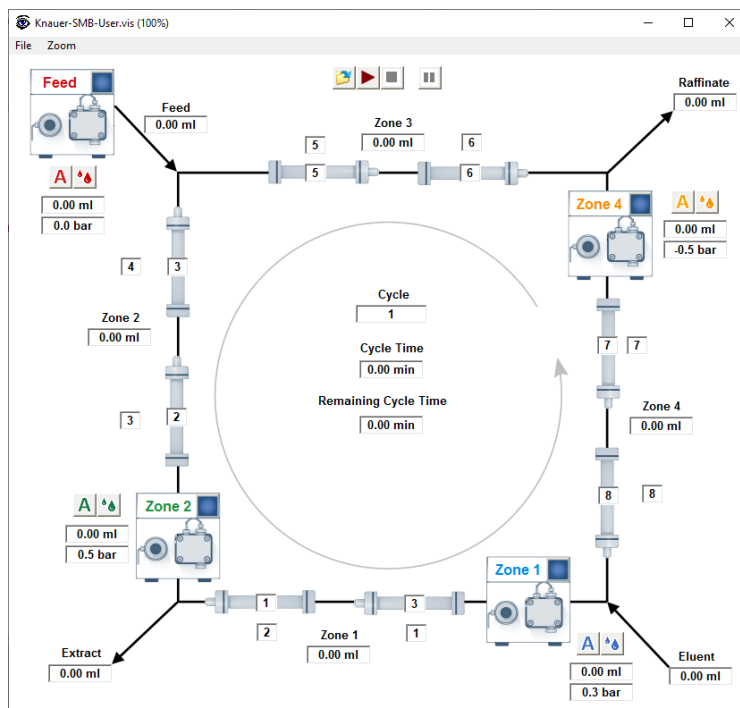

8.5.3 From 2:2:2:2 to 1:1:1:1

This section describes the change of the zone configuration from 2:2:2:2 to 1:1:1:1.

Step	Task
Procedure 1	1 Install one column on every second position: <ol style="list-style-type: none"> Column 1 at Position 1 Column 2 at Position 3 Column 3 at Position 5 Column 4 at Position 7
	2 Install a coupling instead of a column at the position 2, 4, 6, 8.
	3 Calculate the SMB Parameters with the SMB Operating Point Calculator.
	4 Divide the Switching Time in half and run the system with the resulting switching time.

8.6 Adjusting the flow rate of the pump

When you are using the software PurityChrom® MCC Plus, you can adjust the flow rates of the pumps by changing the adjust parameters.



Note: If the flow rate deviation exceeds 10 %, you should check the system before adjusting the flow rates (see chapter „10.3 Possible problems and solutions“ on page 56).

Step	Task
Procedure 1	1 Open the Purity Chrom® MCC setup by clicking
	2 You can adjust the flow rate in section Pump Head Parameters in the tab Presets.

Step	Task
3	Before making any changes, make a note of the current Adjust Parameter.
4	Calculate the new Adjust Parameter using the following equation: $AdjustP_{new} = \frac{AdjustP_{current} \cdot flow\ rate_{pump}}{flow\ rate_{current}}$
5	Change the Adjust Parameter.
6	Close and safe the setup.



Note: If the flow rate does not change after adjusting the Adjust Parameters, undo your changes in the setup and check the system.

8.7 Inline sampling valve

The inline sampling is a way of monitoring the SMB process during which a sample is taken at a specific time point between two switches. For the inline sampling a manual valve is placed before the inlet of column 1 (see Fig. 21). Depending on the position of column 1 within the cycle, all zones can be analyzed.

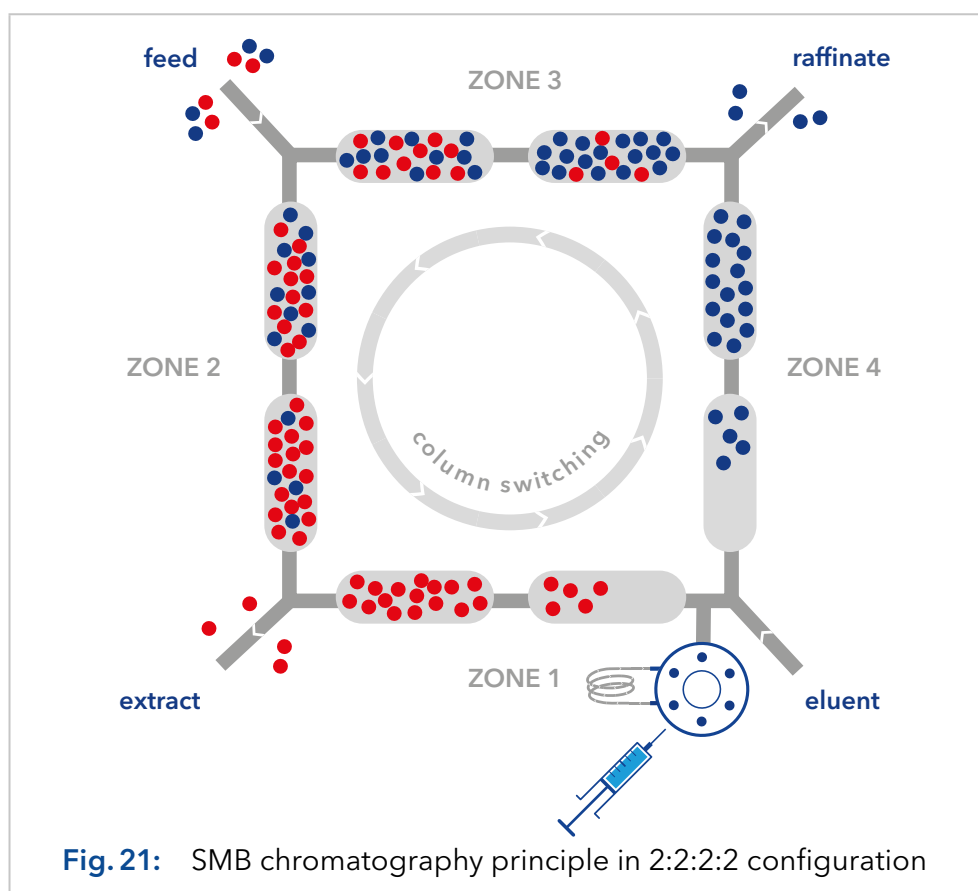

With the additional inline sampling valve, you can monitor each zone separately.

The valve is located before the inlet of column 1 and after the outlet of the SMB system. So, by switching the columns, you can monitor each zone depending on the position of column 1 within the cycle.

You can switch the manually operated inline sampling loop valve between two positions. By switching the valve, you bring the sample loop into the cycle (Pos. 2) and out of the cycle (Pos. 1) as shown in Fig. 22 and Fig. 23.



Note: The port configuration may differ from what is shown in Fig. 22 and Fig. 23.

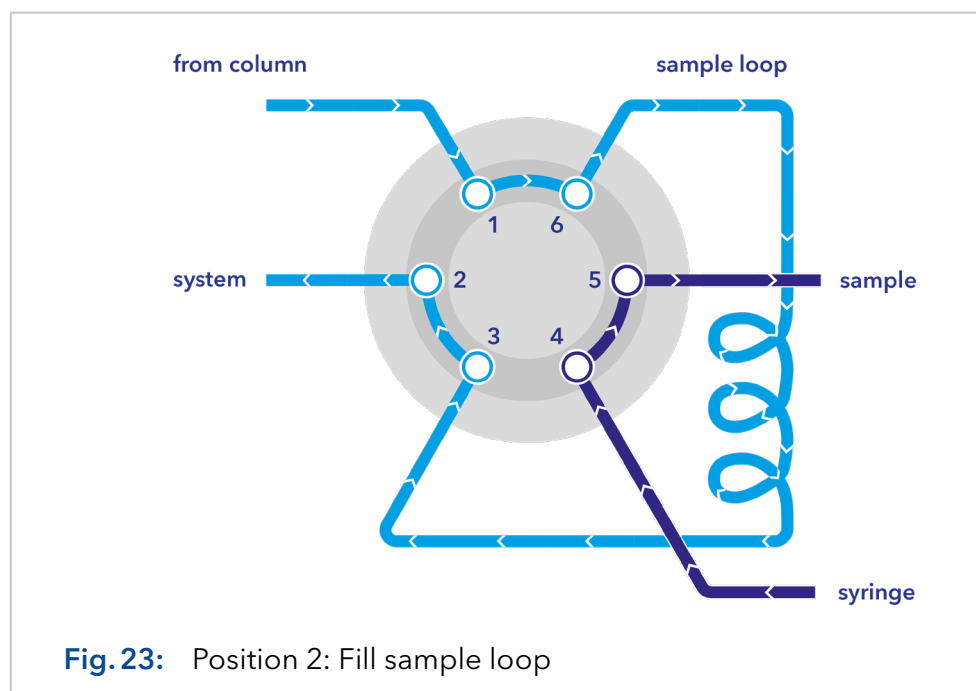
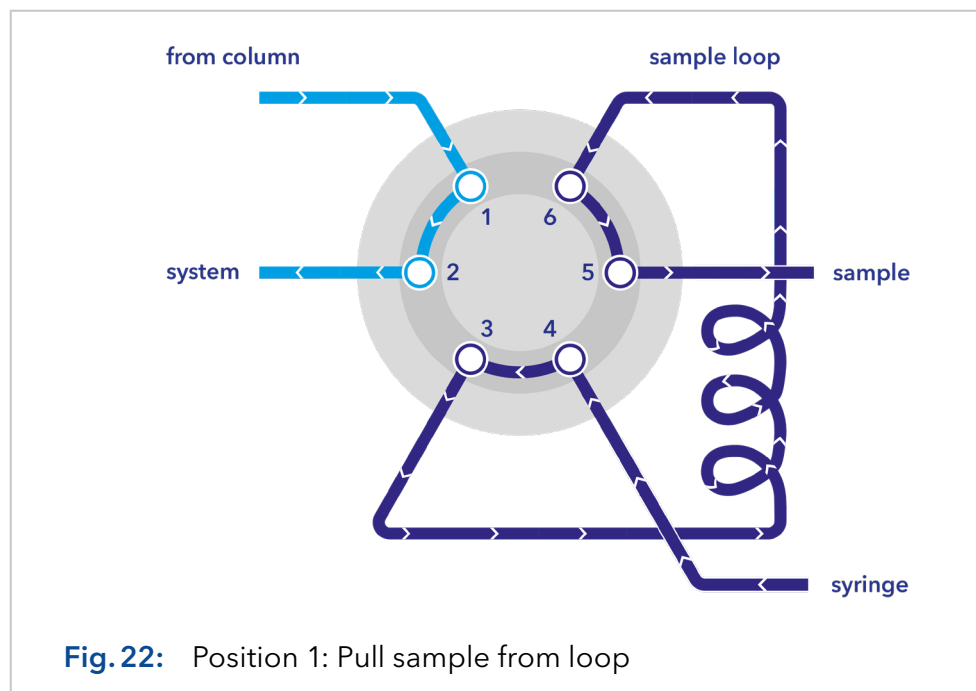

	Step	Task
Procedure	1	Preparation: <ul style="list-style-type: none"> ■ Start with Pos. 1 „Pull sample from loop“. ■ Fill the empty loop with the selected eluent. ■ Use a syringe (valve port 4) for this. ■ Stop the procedure when liquid is visible at valve port 5.
	2	Collect sample: <ul style="list-style-type: none"> ■ Start with Pos. 2 „Fill sample loop“. ■ After collecting the sample, switch back to Pos. 1 „Pull sample from loop“. ■ Press air through the loop with an empty syringe. ■ As a result of this process, your sample will leak out at valve port 5.
	3	Analyse your sample.



Note: For further information see [VTN0011](#).



8.8 Sampling valve

In the AZURA® Lab-SMB, the sample valve facilitates the simultaneous fractionation of the extract and raffinate streams into two respective outlet lines by manually switching the 8-port 2-position valve. This allows you to collect the extract and the raffinate at the same time.

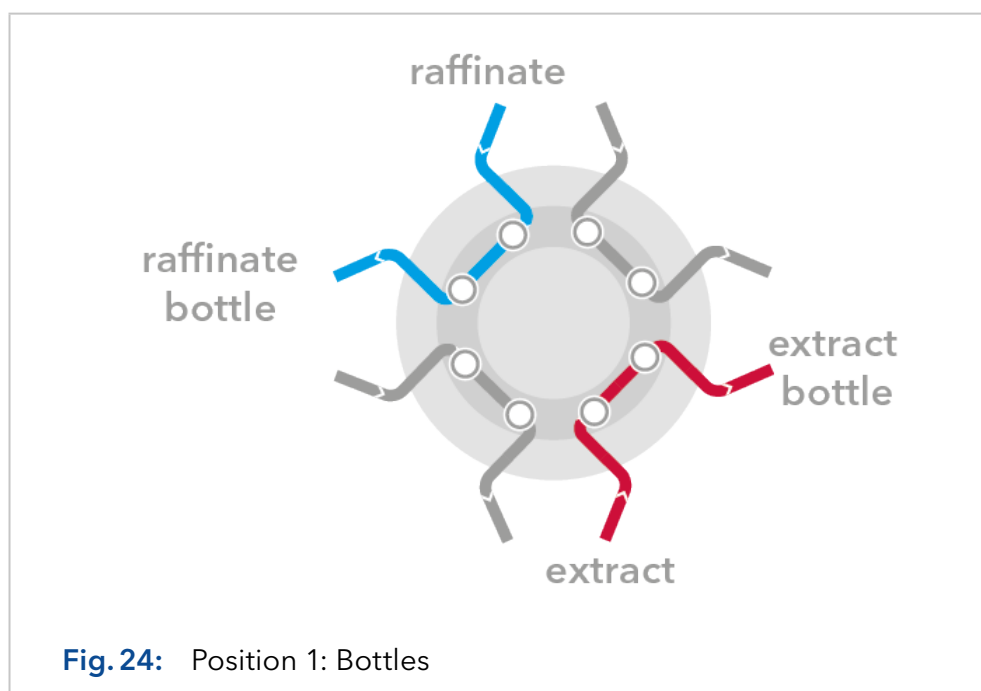

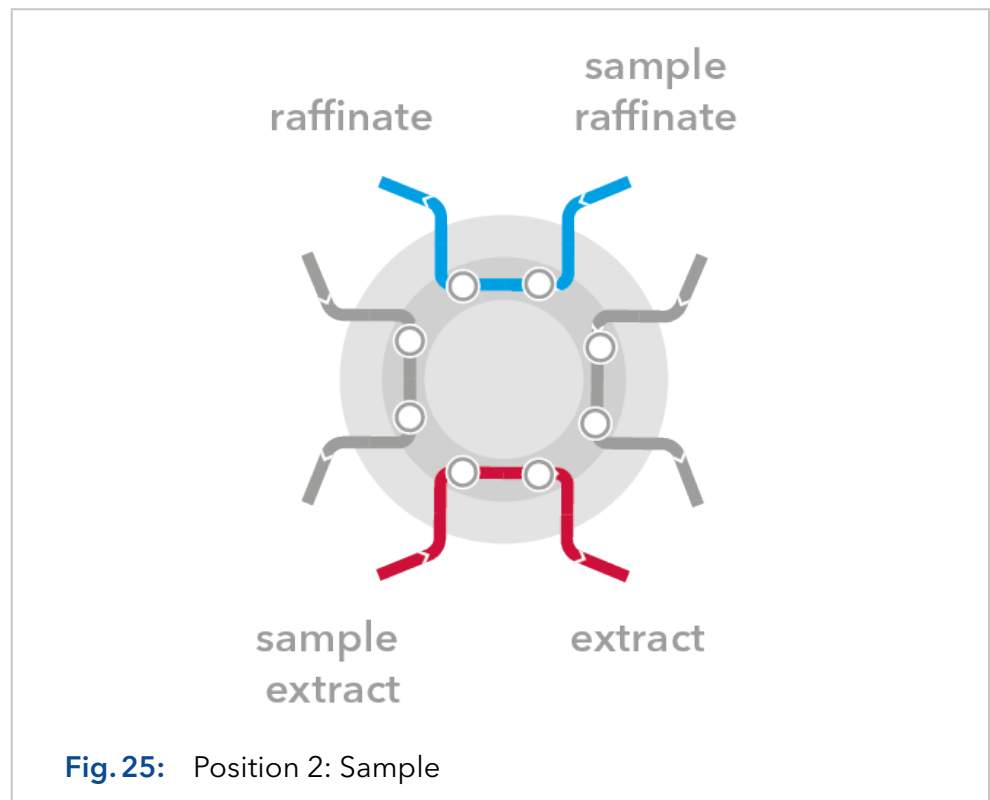

This technique is employed to create a bypass with minimal hold-up volume in the outlet lines of both the extract and raffinate, facilitating the collection of samples immediately after elution outside the system. By switching the valve, choose between the „sample” bypass, characterized by a small hold-up volume, or the „bottle” option for collecting samples in bottles. Both extract and raffinate fractions are generated through valve switching.

 **Note:** For further information see [VTN0012](#).



9. Functionality tests



Note: Standard processes regarding IQ and OQ in single devices may be handled differently in individual cases.

9.1 Installation Qualification (IQ)

The customer may request the Installation Qualification, which is free of charge. In case of a request, the Technical Support of KNAUER or a provider authorized by KNAUER performs this functionality test during the installation.

The Installation Qualification is a standardized document that includes the following:

- Confirmation of flawless condition at delivery
- Check if the delivery is complete
- Certification on the functionality of the device

You can either use the IQ document attached to this instruction manual or download a digital version from our website:



9.2 Operation Qualification (OQ)

The Operation Qualification includes an extensive functionality test according to KNAUER standard OQ documents. The Operation Qualification is a standardized document and free of charge. It is not part of the delivery. In case of a request contact the Technical Support.

The Operation Qualification includes the following:

- Definition of customer requirements and acceptance terms
- Documentation on device specifications
- Device functionality check at installation site

Test intervals

To make sure that the device operates within the specified range, you should test the device regularly. The test intervals depend on the usage of the device.

Execution

The test can be carried out either by the Technical Support of KNAUER or by a provider authorized by KNAUER (for a fee). For further information visit our website:



10. Troubleshooting

10.1 First measures

- Check all cabling.
- Check all screw fittings.
- Check whether air has intruded the supply lines.
- Check the device for leaks.
- Pay attention to system messages.

Further measures:

- Compare occurring errors with the list of possible errors (see below).
- Contact the Customer Support.

10.2 LAN

Go through the following steps, in case no connection between the computer and the devices can be established. Check after each step if the problem is solved. If the problem cannot be located, call the Technical Support.

1. Check the status of the LAN connection in the Windows task bar:



If no connection was established, test the following:

- Is the router switched on?
 - Is the patch cable connected correctly to the router and the computer?
2. Check the router settings:
 - Is the router set to DHCP server?
 - Is the IP address range sufficient for all the connected devices?
 3. Check all connections:
 - Are the patch cable connected to the LAN ports and not the WAN port?
 - Are all cable connections between devices and router correct?
 - Are the cables plugged in tightly?
 4. If the router is integrated into a company network, pull out the patch cable from the WAN port.
 - Can the devices communicate with the computer, even though the router is disconnected from the company network?
 5. Turn off all devices, router, and computer. First switch on the router and wait until it has successfully completed its self-test. Firstly, turn on the router and secondly turn on the devices and the computer.
 - Has this been successful?
 6. Replace the patch cable to the device with that no connection could be established.
 - Has this been successful?
 7. Make sure that the IP port of the device matches the port in the chromatography software.

10.3 Possible problems and solutions



Note: If you have problems with the handling of a single device, read the troubleshooting section of the respective instructions.

Device/system	Problem	Solution
SMB system	During the procedure of the SOP start-up, the eluent exits the wrong outlet.	<ul style="list-style-type: none"> Switch the valve position until you reach the initial valve position and flush the system step by step according to SOP start-up. Check the valve positions. Purge the pumps. Check the external check valves.
	Pump sucks air through the outlets (extract, raffinate, waste).	<ul style="list-style-type: none"> Check the valve position. Check the external check valves.
	Pumps sucks air through the inlet.	Check the filling level of the solvent supply, afterwards proceed SOP start-up.
	Air bubbles in the tubes.	Carefully degas and filter all solvents and feeds before use, afterwards proceed the SOP start-up.
	Pump has frequent pressure drops.	<ul style="list-style-type: none"> Check the check valves of the pump. Degas the mobile phase. Purge the pump.
	Flow rate is to high or to low.	<ul style="list-style-type: none"> Purge the pump. Change the pump head parameters in the Purity Chrom® MCC Plus setup.
Leaksensor oven	Leaksensor shows constant Leaksignal (LED Out is orange).	<ul style="list-style-type: none"> Check for leakage. Check if the sensor has direct contact to the surface. Reduce the sensitivity of the leaksensor by adjusting the ADJ screw counter-clockwise.
Oven	Actual temperature is over the set temperature	Turn off the internal light of the oven, the light bulb heats up fast.
	Oven does not heat.	Check if the timer of the oven is set to 00:00 → turn off the timer.
Valve	Leakage of the valve.	Check the rotor seal of the valve according to technical note 801 and 703.

11. Maintenance and care

11.1 SOP: Cleaning procedure for pressure release valves and connected tubings for AZURA® Pilot SMB

Follow this procedure to clean all pressure release valves and the connected tubings.

Step	Task
1	Turn on Zone 1 pump and set the flow rate at 25 % of the pump heads max. flow.
2	Close the valve "Zone 1 Redirect Flow" and wait 5 min.
3	Open the valve "Zone 1 Redirect Flow".
4	Turn on Zone 2 pump and set the flow rate at 15 % of the pump heads max. flow.
5	Close the valve "Zone 2 Redirect Flow" and wait 5 min.
6	Open the valve "Zone 2 Redirect Flow".
7	Turn on Feed Pump and set the flow rate at 25 % of the pump heads max. flow.
8	Close the valve "Feed Redirect Flow" and wait 5 min.
9	Open the valve "Feed Redirect Flow".
10	Turn on Zone 4 pump and set the flow rate at 10 % of the pump heads max. flow
11	Close the valve "Zone 4 Redirect Flow" and wait 5 min.
12	Open the valve "Zone 4 Redirect Flow".

11.2 Maintaining the AZURA® Lab System

11.2.1 Pumps

Maintenance by customer (please refer to the AZURA Pump P 4.1S manual, document no. [V6870](#)):

For A29101:

- Replacing the pump head AHB40 (feed pump) or AHC20 (zone 1, 2 and 4 pump)
- Exchanging the ball valves A06840 (feed pump and zone 1, 2 and 4 pump)

For A29100:

- Replacing the pump head AHB32 (feed pump) or AHC22 (zone 1, 2 and 4 pump)

Suggest maintenance interval pumps:

Please refer to the Service Manual of the pump (document no. [V6875A](#), available on Partner Area of KNAUER website, only for trained service technicians).

Spare parts for pump heads:

Please refer to the Service Manual for pump heads (document no. [VSM-001](#), available on Partner Area of KNAUER website).

11.2.2 Valves

Please refer to the Service Manual for V 4.1 valves (document no. [VSM-015](#) available on Partner Area of KNAUER website, only for trained service technicians).

Replacement parts:

For A29100:

Valve: AVS34CH

Rotor Seal: A205115

Stator: A205140

For A29101:

Valve: AVS35AH

Rotor Seal: A205115

Stator: A205142

External check valves: A06840

11.3 Maintaining the AZURA® Pilot system**11.3.1 Pumps**

Maintenance by customer (please refer to the pump manual):

- Replacing the pump head A4029-1 (feed pump) or A4038-1 (zone 1, 2 and 4 pump)
- Exchanging the ball valves A1122 (feed pump) or A1080 (zone 1, 2 and 4 pump)

Suggest maintenance interval pumps:

Please refer to the Service Manual of the pump (document no. [V6875A](#), available on Partner Area of KNAUER website, only for trained service technicians).

Spare parts for pump heads:

Please refer to the Service Manual for pump heads (document no. [VSM-001](#), available on Partner Area of KNAUER website).

11.3.2 Valves

Please refer to the Service Manual for V 4.1 valves (document no. [VSM-015](#) available on Partner Area of KNAUER website, only for trained service technicians).

Replacement parts:

Valve: AVU34AH

Rotor Seal: A205163

External check valves: M1077-1

11.4 Decommissioning

Auxiliary material

The system is designed for the use of different solvents. In case the system has not been used for several weeks, solvent residues may cause damage. Therefore, we recommend to:

- Flush the capillaries.
- Completely remove used solvents.
- Fill the capillaries with isopropanol.

Prerequisites

- The system has been flushed.

Hole plugs and/or cap fittings

Process

Steps

1. Unscrew the eluent supply lines and close the open connectors with hole plugs.
2. Disconnect the system.

Next step

- Select a storage location according to the requirements (see chapter „12. Technical data“ on page 61).

11.5 Transport

Carefully prepare the device for transport. If you want to return your device to KNAUER for repairs, enclose the Service Request Form which can be downloaded from our website. For a secure transport, note the weight and dimensions of the device (see chapter „12. Technical data“ on page 61).

CAUTION

Bruising danger

Damage to the device by carrying or lifting it on protruding housing parts. The device may fall and thus cause injuries.

➔ Lift the device only centrally on the side of the housing.

11.6 Storage

Pay attention that all tubes and capillaries have been emptied or filled with flushing solution (e. g. isopropanol) before storage. To prevent algae formation, do not use pure water. Close all inputs and outputs with cap fittings.



Note: Pay attention to the ambient conditions for storage (see chapter „12. Technical data“ on page 61).

11.6.1 Disconnecting the power supply

Prerequisites

- The devices are switched off.

Process

Steps

1. Pull the power plug out of the socket and afterwards out of the devices.
2. Store the power cables together with the devices.

Next step

- Disconnect further electrical connections. Remove all accessories and pack the devices in a box for transport or storage.

12. Technical data

12.1 General system parameters

Parameter	AZURA® SMB Lab	AZURA® SMB Pilot - Standard	AZURA® SMB Pilot - High flow
Max. flow rate*	50 ml/min	500 ml/min	1000 ml/min
Max. continuous flow rate*	30 ml/min	250 ml/min	400 ml/min
Max. flow rate Feed pump*	10 ml/min	100 ml/min	250 ml/min
Max. continuous flow rate Feed pump*	4 ml/min	40 ml/min	100 ml/min
Pressure range*	5 - 130 bar	2 - 100 bar	2 - 60 bar
Max. temperature	60 °C / 140 °F	60 °C / 140 °F	60 °C / 140 °F
Max. number of columns	8	8	8
Column dimensions	Up to 30 mm ID	Up to 50 mm ID	Up to 100 mm ID
Column configuration	2:2:2:2 1:3:3:1 1:1:1:1 User defined	2:2:2:2 1:3:3:1 1:1:1:1 User defined	2:2:2:2 1:3:3:1 1:1:1:1 User defined

* The maximum operating parameters for flow and pressure depend on the specific columns and customer application. Due to the increased wear of consumables, it is not recommended to operate the system close to both maximum values for pressure and flow rate.

12.2 Technical parameters

Parameter	AZURA® SMB Lab	AZURA® SMB Pilot
Supported software package	PurityChrom® MCC	PurityChrom® MCC
Ambient conditions	Temperature range 4-40 °C, 39.2-104 °F Humidity: below 90 %, non-condensing	Temperature range 4-40 °C, 39.2-104 °F Humidity: below 90 %, non-condensing
Power supply	100-240 V; 50- 60 Hz; max. 130 W for ASM 2.2L	100-240 V; 50- 60 Hz; maximum 130 W for ASM 2.2L; Max. 320 W for P 2.1L
Dimensions (W × H × D)	361 × 917 × 625 mm	1465 × 1200 × 785 mm
Weight	Approx. 70 kg	Approx. 250 kg

12.3 Wetted materials

Valid for AZURA® SMB Lab system (Art. Nr. A29000 and A29001) and AZURA® SMB Pilot system (Art. No. A29201 and A29202).



Note: For chemical compatibility of wetted materials see chapter „14. Chemical compatibility of wetted materials“ on page 65.

The components of the SMB system contain the following wetted parts:

Pumps

Material	Description
1.4401/1.4404	Stainless Steel
Ti ₆ Al ₄ V	Titanium
Al ₂ O ₃ /ZrO ₂ ***	Ceramics
FPM (FKM)	Fluorinated rubber
GFP55-27	Graphite fiber reinforced PTFE
PEEK	Polyetheretherketone
Al ₂ O ₃	Ruby
Al ₂ O ₃	Sapphire

Valves

Material	Description
SST-DLC (Stator)*	Stainless steel DLC (diamond-like carbon) coating
PEEK (Stator)**	Polyetheretherketone
PEEK TX (Rotor)	Internally lubricated Polyetheretherketone

*only for A29101, A29201 and A29202

**only for A29100

***only for A29201 and A29202

Capillaries & fittings

Material	Description
Stainless Steel*	1.4401
PEEK**	Polyetheretherketone
FEP	Fluorinated Ethylene Propylene
PETP	Polyethylene terephthalate
FFKM**	Perfluoroelastomer
PTFE	Polytetrafluoroethylene

*only for A29101, A29201 and A29202

**only for A29100

13. Reorders

The list of repeat orders is current at the time of publication. Deviations at a later time are possible. Use the enclosed packing list for reordering spare parts. If you have any questions regarding spare parts or accessories, please contact our Customer Support.

Further information Current information on spare parts and accessories can also be found on our website: www.knauer.net.

13.1 Heating and column organisation

Description	Order no.
Oven for AZURA® SMB Lab and AZURA® SMB Pilot systems (8 KNAUER columns with up to 250 × 50 mm ID).	A29903
Custom-made column heating sleeve for HPLC columns	A57032
Column holder for 8 SMB columns with up to 250 × 50 mm	A29901
Column holder for 8 SMB columns with: <ul style="list-style-type: none"> ■ 8 mm, 16 mm ID and up to 250 mm length or ■ 20 mm ID and 150 mm length 	A29902

13.2 System and process control

Description	Order no.
One mini CORI-FLOW™ M13 for AZURA® SMB Lab, incl. accessories	A29800
Four mini CORI-FLOW™ M13 for AZURA® SMB Lab, incl. accessories	A29801
One mini CORI-FLOW™ M14 for AZURA® SMB Pilot, incl. accessories	A29802
Four mini CORI-FLOW™ M14 for AZURA® SMB Pilot, incl. accessories	A29803
One mini CORI-FLOW™ M13 Hastelloy for AZURA® SMB Lab, incl. accessories	A29805
Compact single wavelength UV detector (190 - 500 nm, small variable single wavelength UV detector)	ADA00
Compact single wavelength UV detector with remote flow cell (190 - 500 nm, small variable single wavelength UV detector)	ADA05
Superior single wavelength UV detector with fiber optic connectors (190 - 750 nm, variable single wavelength UV/ VIS detector)	ADA04XA
High flow rate compatible RI detector for LC and process technology	ADD38

Description	Order no.
Conductivity monitor mikron 81 with biocompatible flow cell for up to 100 ml/min	ADG61GD
Conductivity monitor mikron 81 with biocompatible flow cell for up to 1 000 ml/min	ADG61GE
Sampling Valve for AZURA® Biocompatible SMB Lab, incl. accessories	A29904
Sampling Valve for AZURA® Stainless Steel SMB Lab, incl. accessories	A29905
Inline Sampling Valve for AZURA® Biocompatible SMB Lab, incl. accessories	A29906
Inline Sampling Valve for AZURA® Stainless Steel SMB Lab, incl. accessories	A29907



Note: Contact KNAUER for help choosing the right detector.

13.3 Services

Description	Order no.
Standard installation and familiarization Europe	A0000SMBEU
Standard installation and familiarization International	A0000SMBIN
SMB/PurityChrom MCC, support via Teamviewer	A2658
SMB Academy: individual, at KNAUER headquarters (1 Day workshop, 5 participants)	AL0531
Academy: SMB Basics, at KNAUER headquarters (1 Day workshop, 1 participant)	AL0590
Academy: SMB Basics, Online Workshop (4h workshop, 1 participant)	AL0590-1
Academy: SMB Method Development, at KNAUER headquarters (2 days workshop, 1 participant)	AL0591
Academy: SMB Basics Training, individual, on-site (1 day workshop, 5 participants)	AL0592
Rent an SMB expert, SMB support, on-site (1 day, daily rate)	AL0701
SMB Method Development at KNAUER headquarters (1 day, daily rate)	AL0702
SMB Method Development on site (1 day, daily rate)	AL0703



Note: Before ordering the service, contact KNAUER for an individual consultation.

14. Chemical compatibility of wetted materials



Note: The user takes the responsibility for using the fluids and chemicals in an appropriate and safe way. If there is any doubt, contact the Technical Support of the manufacturer.

14.1 General

The device is very resistant against a variety of commonly used eluents. However, make sure that no eluents or water come in contact with the device or enter into the device. Some organic solvents (such as chlorinated hydrocarbons, ether) may cause coating damage or loosen glued components by improper handling. Even small quantities of other substances, such as additives, modifiers, or salts can influence the durability of the materials. Exposure time and concentration have a high impact on the resistance.

The following list contains information about the chemical compatibility of all wetted materials which are used in devices made by KNAUER. The data bases on a literature research on the manufacturer specifications of the materials. The wetted materials of this device are listed in the chapter "Technical data".

All resistances mentioned here are for use at temperatures up to 40 °C, unless stated otherwise. Please note that higher temperatures can significantly affect the stability of different materials.

14.2 Plastics

Polyetheretherketone (PEEK)

PEEK is a durable and resistant plastic and, next to stainless steel, the standard material in HPLC. It can be used at temperatures up to 100 °C and is highly chemical resistant against almost all commonly used solvents in a pH range of 1 - 12.5. PEEK is potentially moderate resistant against oxidizing and reducing solvents.

Therefore, following solvents should not be used: Concentrated and oxidizing acids (such as nitric acid solution, sulfuric acid), halogenated acids (such as hydrofluoric acid, hydrobromic acid) and gaseous halogens. Hydrochloric acid is approved for most applications.

In addition, following solvents can have a swelling effect and may have an impact on the functionality of the built-in components: Methylene chloride, THF and DMSO in any concentration such as acetonitrile in higher concentrations.

Polyethylene terephthalate (PET, outdated PETP)

PET is a thermoplastic and semi-crystalline material with high wear resistance. It is resistant against diluted acids, aliphatic and aromatic hydrocarbons, oils, fats and alcohols, but not against halogenated hydrocarbons and ketones. Since PET belongs chemically to esters, it is not compatible with inorganic acids, hot water and alkalis.

Maximum operating temperature: up to 120 °C.

Polyimide (Vespel®)

This material is wear-resistant and permanent resilient thermally (up to 200 °C) as well as mechanically. It is chemically broadly inert (pH range 1 - 10) and is especially resistant against acidic to neutral and organic solvents, but vulnerable to pH strong chemical or oxidizing environments: It is incompatible with concentrated mineral acids (such as sulfuric acid), glacial acetic acid, DMSO and THF. In addition, it will be disintegrated by nucleophilic substances like ammonia (such as ammonium salts under alkaline conditions) or acetate.

Ethylene-tetrafluorethylene copolymer (ETFC, Tefzel®)

This fluorinated polymer is highly resistant against neutral and alkaline solvents. Some chlorinated chemicals in connection with this material should be handled with care. Maximum operating temperature is 80 °C.

Perfluorethylenpropylen-Copolymer (FEP), Perfluoralkoxy-Polymer (PFA)

These fluorinated polymers hold similar features as PTFE, but with a lower operation temperature (up to 205 °C). PFA is suitable for ultrapure applications, FEP can be used universally. They are resistant against almost all organic and inorganic chemicals, except elemental fluorine under pressure or at high temperatures and fluorine-halogen compounds.

Polyoxymethylene (POM, POM-HTF)

POM is a semi-crystalline, high-molecular thermoplastic material which stands out due to its high stiffness, low friction value and thermic stability. It can even substitute metal in many cases. POM-HTF is a combination of PTFE fibres and acetal resin and is softer and has better slip properties as POM. The material is resistant against diluted acids (pH > 4) as well as diluted lyes, aliphatic, aromatic and halogenated hydrocarbons, oils and alcohols. It is not compatible with concentrated acids, hydrofluoric acid and oxidizing agent. Maximum operating temperature is 100 °C.

Polyphenylene sulfide (PPS)

PPS is a soft polymer which is known for its high break resistance and very high chemical compatibility. It can be used with most organic, pH neutral to pH high, and aqueous solvents at room temperature without concerns. However, it is not recommended for using with chlorinated, oxidizing and reducing solvents, inorganic acids or at higher temperatures. Maximum operating temperature: 50 °C.

Polytetrafluorethylene (PTFE, Teflon®)

PTFE is very soft and anti-adhesive. This material is resistant against almost all acids, lyes and solvents, except against fluid sodium and fluoride compounds. In addition, it is temperature-resistant from -200 °C to +260 °C.

System AF™

This amorphous perfluorinated copolymer is inert against all commonly used solvents. However, it is soluble in perfluorinated solvents like Fluorinert® FC-75 and FC-40, and Fomblin perfluor-polyether solvents from Ausimont. In addition, it is affected by Freon® solvents.

Polychlorotrifluorethylene (PCTFE, Kel-F®)

The semi-crystalline thermoplastic material is plasticizer-free and dimensionally stable, even in a wide temperature range (–240 °C to +205 °C). It is moderately resistant against ether, halogenated solvents and toluene. Halogenated solvents over +60 °C and chlorine gas should not be used.

Fluorinated rubber (FKM)

The elastomer consisting of fluorinated hydrocarbon stands out due to a high resistance against mineral oils, synthetic hydraulic fluids, fuels, aromatics, and many organic solvents and chemicals. However, it is not compatible with strong alkaline solvents (pH value > 13) like ammonia, and acidic solvents (pH value < 1), pyrrole and THF.

Operating temperature: Between –40 °C and +200 °C.

Perfluorinated rubber (FFKM)

This perfluoro elastomer has a higher fluorine content as fluorinated rubber and is therefore chemically more resistant. It can be employed at higher temperatures (up to 275 °C). It is not compatible with Pyrrole.

14.3 Non-metals

Diamond-like carbon (DLC)

This material is characterized by a high hardness, a low coefficient of friction and thus low wear. In addition, it is highly biocompatible. DLC is inert against all acids, alkalis and solvents commonly used in HPLC.

Ceramic

Ceramic is resistant against corrosion and wear and is fully biocompatible. An incompatibility against acids, alkalis and solvents commonly used in HPLC is not known.

Alumina (Al₂O₃)

Due to their high resistance to wear and corrosion, alumina ceramic is used as a coating for mechanically stressed surfaces. It is a biocompatible material with low thermal conductivity and low thermal expansion.

Zirconium oxide (ZrO₂)

Zirconia ceramics are characterized by their high mechanical resistance, which makes them particularly resistant to wear and corrosion. It is also biocompatible, has low thermal conductivity and is resistant to high pressures.

Sapphire

Synthetic sapphire is virtually pure monocrystalline alumina. It is biocompatible and very resistant to corrosion and wear. The material is characterized by a high hardness and a high thermal conductivity.

Ruby

Synthetic ruby is monocrystalline alumina and gets its red color by the addition of some chromium oxide. It is biocompatible and very resistant to corrosion and wear. The material is characterized by a high hardness and a high thermal conductivity.

Mineral wool

This insulating material consists of glass or stone wool fibres and isolates in high oxidizing conditions and at high temperatures. Mineral wool is valid as commonly inert against organic solvents and acids.

Glass, glass fibre, quartz, quartz glass

These mineral materials are resistant against corrosion and wear and are mostly chemical inert. They are compatible with oils, fats and solvents and show a high resistance against acids and lyes up to pH values of 3 - 9. Concentrated acids (especially hydrofluoric acid) may embrittle and corrode the minerals. Lyes may ablate the surfaces slowly.

14.4 Metals

Stainless steel

Stainless steel is, apart from PEEK, the standard material in HPLC. Steels with WNr. 1.4404 (316L) are used, or with a mixture of higher compatibility.

They are inert against almost all solvents. Exceptions are biological applications which are metal ion sensible, and applications with extreme corrosive conditions. These steels, in comparison to commonly used steels, are increasingly resistant against hydrochloric acid, cyanides and other halogen acids, chlorides and chlorinated solvents.

The use in ion chromatography is not recommended. In case of electrochemical applications, a passivation must be executed first.

Hastelloy®-C

This nickel-chrome-molybdenum alloy is extremely resistant to corrosion, especially against oxidizing, reducing and mixed solvents, even at high temperatures. This alloy may be used in combination with chlorine, formic acid, acetic acid and saline solutions.

Titanium, titanium alloy (TiAl₆V₄)

Titanium has a low weight and a high hardness and stability. It stands out due to its very high chemical compatibility and biocompatibility. Titan is applied when neither stainless steel nor PEEK are usable.

15. Disposal

Hand in old devices or disassembled old components at a certified waste facility, where they will be disposed of properly.

15.1 AVV-Marking Germany



According to the German "Abfallverzeichnisverordnung" (AVV) (January, 2001), old devices manufactured by KNAUER are marked as waste electrical and electronic equipment: 160214.

15.2 WEEE registration number

KNAUER as a company is registered by the WEEE number DE 34642789 in the German "Elektroaltgeräteregister" (EAR). The number classifies to category 8 and 9, which, among others, comprises laboratory equipment.

All distributors and importers are responsible for the disposal of old devices, as defined by the WEEE directive. End-users can send their old devices manufactured by KNAUER back to the distributor, the importer, or the company free of charge.

15.3 Eluents and other operating materials

All eluents and other operating materials must be collected separately and disposed of properly.

All wetted components of a device, e. g. flow cells of detectors or pump heads and pressure sensors for pumps, have to be flushed with isopropanol first and water afterwards before being maintained, disassembled or disposed.

16. Checklist

Transportation and storage

- There has to be enough space available for storing the shipping pallet.
-

System setup

- A lab table with adequate carrying capacity and dimensions is available.
 - The power supply and cables are available.
 - The power supply and cables comply with the requirements.
-

Ambient conditions at installation site

The installation site complies with the requirements with respect to:

- Equipment
 - Temperature
 - Humidity
 - Vibration
 - High frequency emissions
-

Computer and operating system

- The computer complies with the requirements or is delivered by KNAUER.
-

Science with Passion



Latest KNAUER instructions online:
www.knauer.net/library

KNAUER
Wissenschaftliche Geräte GmbH
Hegauer Weg 37-38
14163 Berlin

Phone: +49 30 809727-0
Fax: +49 30 8015010
E-mail: info@knauer.net
Internet: www.knauer.net