

Science with Passion

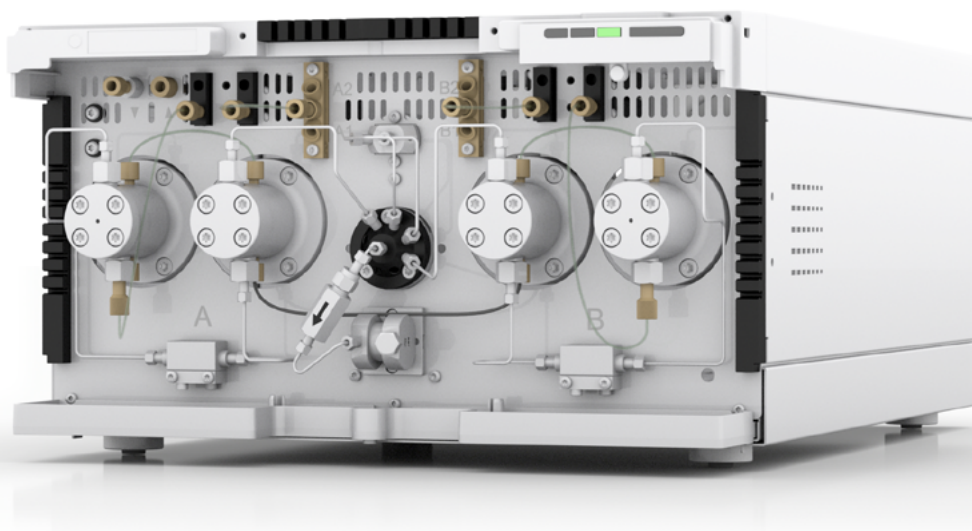

Azura

Pump P 8.1L Instructions



Document no. V6770

HPLC



Note: For your own safety, read the instructions and observe the warnings and safety information on the device and in the instructions. Keep the instructions for future reference.



Note: In case you require this instruction in another language, please submit your request including the corresponding document number via e-mail or fax to KNAUER.

Support: Do you have questions about the installation or the operation of your instrument or software?

International Support:

Contact your local KNAUER partner for support:

www.knauer.net/en/Support/Distributors-worldwide

Support in Germany

(Austria & Switzerland on case-to-case basis):

Phone: +49 30 809727-111 (workdays 9-17h CET)

Fax: +49 30 8015010

E-mail: support@knauer.net

Publisher: KNAUER Wissenschaftliche Geräte GmbH

Hegauer Weg 38

14163 Berlin

Germany

Phone: +49 30 809727-0

Fax: +49 30 8015010

Internet: www.knauer.net

E-mail: info@knauer.net

Version information: Document number: V6770

Version number: 1.0

Release date: March 31, 2023

Translation of the original edition

These instructions apply to products with the product number: EPF45

The information in this document is subject to change without prior notice. For the latest version of the instructions, visit our website: www.knauer.net/library.



Sustainability: The printed versions of our instructions are printed on recycled paper that has been awarded the Blue Angel.

Copyright: This document contains confidential information and may not be reproduced without written consent of KNAUER Wissenschaftliche Geräte GmbH.

© KNAUER Wissenschaftliche Geräte GmbH 2023
All rights reserved.

AZURA® is a registered trademark of KNAUER Wissenschaftliche Geräte GmbH.

Table of contents

1. General	1
1.1 About these instructions	1
1.2 Signal words	1
1.3 Additional typographical conventions	1
1.4 Legal information	2
1.4.1 Liability limitation	2
1.4.2 Transport damage	2
1.4.3 Warranty conditions	2
1.4.4 Warranty seal	2
1.4.5 Declaration of conformity	2
2. Basic safety instructions	3
2.1 Intended use	3
2.1.1 Operating ranges	3
2.1.2 Foreseeable misuse	3
2.2 User qualification	3
2.3 Operator responsibility	4
2.4 Personal safety equipment	4
2.5 Safety features on the device	4
2.6 Working with solvents	5
2.6.1 General requirements	5
2.6.2 Contamination by health-threatening solvents	5
2.6.3 Avoiding leakage	5
2.7 Specific environments	6
2.7.1 Earthquake-endangered areas	6
2.7.2 Explosive environment	6
2.7.3 Cooling room	6
2.7.4 Wet room	6
2.8 Maintenance, care and repair	6
2.9 Service request form and decontamination report	7
3. Product information	8
3.1 AZURA® L features	8
3.2 Views	8
3.2.1 Rear view	10
3.3 Performance features	10
3.4 Scope of delivery	11
3.5 Symbols and signs	12
4. Installation and start-up	14
4.1 Unpacking	14
4.2 Ambient conditions	14
4.2.1 Location	14
4.2.2 Ambient temperature	15
4.2.3 Space requirements	15

4.3	Power supply	15
4.4	Connecting the leak management	16
4.5	Connecting the piston backflushing	18
4.5.1	Procedure	19
4.6	Connecting the capillaries	22
4.7	Integrating the pump into a system	23
4.7.1	Connecting capillaries and tubings	23
4.7.2	Connecting the degasser	24
4.7.3	Connecting the solvent selection valve to eluent	25
4.7.4	Connecting the purge valve	26
4.8	Computer control	28
4.8.1	Setting up LAN	28
4.8.2	Configuring LAN settings	28
4.8.3	Connecting devices with LAN	29
4.8.4	Configuring the router	30
4.8.5	Integrating LAN into the company network	30
4.8.6	Controlling several systems separately in LAN	31
4.9	Setting IP addresses via software	31
4.9.1	Mobile Control: Setting a static IP address	31
4.9.2	Mobile Control: Setting a dynamic IP address via device name	32
4.9.3	Mobile Control: Setting a dynamic IP address via device serial number	33
4.9.4	Firmware Wizard: Setting a static IP address	34
4.9.5	Firmware Wizard: Setting a dynamic IP address	35
4.9.6	Setting a static IP address via APIPA	35
4.10	Remote control	36
4.10.1	Connector assignment	36
4.10.2	Events connector	37
4.10.3	Connecting the pin header	39
5.	Operation	41
5.1	Initial start-up	41
5.2	Control	41
5.3	Meaning of the LEDs	42
5.4	Switching on the pump	43
5.5	Pump head running-in	43
5.6	Activate standby	44
6.	Functionality tests	45
6.1	Installation Qualification (IQ)	45
6.2	Operation Qualification (OQ)	45
7.	Troubleshooting	46
7.1	LAN	46
7.2	Possible problems and rectifications	47
7.3	System messages	48

8. Maintenance and care	50
8.1 Maintenance contract	50
8.2 Maintenance intervals	50
8.3 Cleaning and caring for the device	51
8.3.1 Cleaning surfaces	51
8.3.2 Flushing the pump	51
8.4 Check the torque of the screw fittings	51
8.5 Dismounting the pump head	52
8.6 Check valves	53
8.6.1 Removing check valves	53
8.6.2 Cleaning check valves	54
8.6.3 Installing check valves	54
8.6.4 Removing dummy check valves	55
8.6.5 Installing dummy check valves	55
8.7 Replacing the mixing chamber	57
8.8 Replacing the inline filter cartridge	58
8.8.1 Location of inline filter cartridge holder	58
8.8.2 Exchanging the inline filter	58
8.9 Removing a leakage	60
8.10 Taking the pump out of service	61
9. Transport and storage	62
9.1 Packing the device	62
9.2 Transporting the device	62
9.3 Storing the device	62
10. Disposal	63
10.1 AVV-Marking Germany	63
10.2 WEEE registration number	63
10.3 Eluents and other operating materials	63
11. Technical data	64
11.1 Main features	64
11.2 Communication	64
11.3 General	65
12. Repeat orders	66
12.1 Device	66
12.2 Accessories and spare parts	66
13. Chemical compatibility of wetted materials	68
13.1 General	68
13.2 Plastics	68
13.3 Non-metals	70
13.4 Metals	71

1. General

1.1 About these instructions

These operating instructions enable the safe and efficient operation of the device. The user must have carefully read and understood these operating instructions before starting any work.





The basic prerequisite for safe operation is compliance with all safety instructions (see „2 Basic safety instructions“, p. 3). In addition to the safety and warning instructions in these operating instructions, the local accident prevention regulations and the national industrial safety regulations apply.

These operating instructions are an integral part of the device. It must be kept in the immediate vicinity of the device and accessible to the user at all times.

You can download these and other instructions from the KNAUER website: www.knauer.net/library

1.2 Signal words

Possible dangers related to the device are distinguished in personal and material damages.

Symbol	Meaning
	DANGER (red) indicates a highly hazardous situation. If not avoided, it will result in death or serious injury.
	WARNING (orange) indicates a hazardous situation. If not avoided, it could result in death or serious injury.
	CAUTION (yellow) indicates a moderate hazardous situation. If not avoided, it could result in minor or moderate injury.
	NOTICE (blue) is used to address issues which are not related to physical injury.

1.3 Additional typographical conventions

- General equal treatment: When persons are described, this document uses the male grammar form to keep the text easy to read. The form has a neutral sense and speaks to people of any gender in the same way.
- Note: Specific information are prefixed with the word "Note" and an information icon.

 **Note:** This is an example.

1.4 Legal information

1.4.1 Liability limitation

The manufacturer is not liable for the following issues:

- Non-compliance of these instructions
- Non-observance of necessary safety precautions
- Improper use
- Operation of the device by unqualified personnel (see chapter 2.2 on page 3)
- Use of non-approved spare parts
- Technical changes by the user such as opening the device and unauthorized modifications
- Violations of General Terms and Conditions (GTC)

1.4.2 Transport damage

The packaging of our devices provides the best possible protection against transport damage. However, check the packaging for transport damage. In case you notice any damage, inform the Technical Support and the shipping company within three workdays.

1.4.3 Warranty conditions

For information on warranty please refer to our general terms and conditions on the website: www.knauer.net/terms

1.4.4 Warranty seal

A blue or orange warranty seal is affixed to some devices.

- A blue seal is used by KNAUER's Manufacturing or Customer Support for devices to be sold.
- After repair, service technicians attach an orange seal onto the identical position.

After repair, the service technician affixes an orange seal in the same place. If unauthorised persons tamper with the device or if the seal is damaged, the warranty will lapse.



1.4.5 Declaration of conformity

The declaration of conformity is enclosed as a separate document with the product and can be obtained online:

www.knauer.net/en/Support/Declarations-of-conformity

2. Basic safety instructions

The device has been developed and constructed in such a way that hazards arising from its intended use are largely excluded. Nevertheless, the following safety instructions must be observed in order to exclude residual hazards.

2.1 Intended use

Only use the device for applications that fall within the range of the intended use. Otherwise, the protective and safety equipment of the device could fail.

2.1.1 Operating ranges

The device is intended to be used for chromatographic applications in the laboratory.

2.1.2 Foreseeable misuse

Refrain from the use of the device for the following purposes or conditions:

- Medical purposes. The device is not approved as a medical product.
- Operating outside of a laboratory or measurement room. Otherwise, the manufacturer does not guarantee the functionality and safety of the device.
- Operation in potentially explosive areas without special and additional explosion protection. Contact the KNAUER Customer Support for more information.

2.2 User qualification

The user is qualified to handle the device if all of the following points apply:

- He has at least a basic knowledge of liquid chromatography.
- He has knowledge about the properties of the used solvents and their health risks.
- He is trained for the special tasks and activities in the laboratory and knows the relevant standards and regulations.
- Due to his technical training and experience, he can understand and carry out all the work described in the operating instructions on the instrument and recognize and avoid possible dangers independently.
- His ability to react is not impaired by the consumption of drugs, alcohol or medication.
- Participation in the installation of a device or a training by the company KNAUER or an authorized company.

If the user does not meet these qualifications, he must inform his supervisor.

2.3 Operator responsibility

The operator is any person who operates the device himself or leaves it to a third party for use and who bears the legal product responsibility for the protection of the user or third parties during operation.

The obligations of the operator are listed below:

- Know and follow the applicable work safety regulations.
- Identify hazards arising from the working conditions at the place of use in a risk assessment.
- Set up operating instructions for the operation of the device.
- Regularly check whether the operating instructions correspond to the current status of the regulations.
- Clearly regulate and specify responsibilities for installation, operation, troubleshooting, maintenance and cleaning and set clear rules.
- Ensure that all personnel who work with the device have read and understood these operating instructions.
- Train the personnel who work with the device at regular intervals and inform them about the dangers.
- Provide the necessary safety equipment to the employees working with the unit (see section below).

2.4 Personal safety equipment

The protective measures required in the laboratory must be observed and the following protective clothing worn during all work on the device:

- Safety glasses with side protection
- Protective gloves in accordance with the prevailing ambient conditions and used solvents (e.g. heat, cold, protection against chemicals)
- Lab coat
- Personalised protective safety equipment which is specified in the particular laboratory

2.5 Safety features on the device

- Power switch: Devices of the AZURA® L series may be switched off using the power switch (toggle switch on the back side of housing) at any time, this causes no damage to the device. To switch off devices of the AZURA® S series, remove the plug from the power socket.
- Front cover: Devices of the AZURA® L series have a front cover as a splash protection for the user.
- Leak tray: Devices of the AZURA® L series have a leak tray on the front side. The leak tray collects leaking solvents and protects components from potential damage caused by discharging liquid.

2.6 Working with solvents

2.6.1 General requirements

- The user is trained for handling different solvents.
- Note recommended solvents and concentrations in these instructions in order to avoid personal injury or damage to the device. For example, certain chemicals may cause PEEK capillaries to swell or burst (see chapter 13 on page 69).
- Note that organic solvents are toxic above a certain concentration. For handling hazardous solvents see the following section.
- Mobile phases and samples may contain volatile or combustible solvents. Avoid the accumulation of these substances. Ensure good ventilation of the installation site. Avoid open flames and sparks. Do not operate the instrument in the presence of flammable gases or vapors.
- Only use solvents which do not self-ignite under given conditions. This applies especially to the use of a thermostat where liquids could get onto hot surfaces in the interior.
- Only flammable liquids with a self-ignition temperature of more than 150 ° C may be used with the device.
- Degas solvents before use and observe their purity.

2.6.2 Contamination by health-threatening solvents

- Contamination with toxic, infectious or radioactive substances poses a hazard for all persons involved during operation, repair, sale, and disposal of a device.
- All contaminated devices must be properly decontaminated by a specialist company or the operating company before they can be recommissioned, repaired, sold, or disposed (see chapter 10 on page 63).

2.6.3 Avoiding leakage

Risk of electrical shock or short circuit if solvents or other liquids leak into the interior of the device. You can avoid a leakage through the following measures:

- Tightness: Visually check the device or system regularly for leaks.
- Solvent tray: The use of a solvent tray prevents liquids get from the bottles into the inside of the device.
- Eluent lines: Install capillaries and hoses in such a way that, in case of a leak, liquids cannot get into the interior of the devices underneath.
- In case of leakage: Switch off the system. Only take the device into operation if the cause of the leak has been resolved (see chapter 8 on page 50).

2.7 Specific environments

2.7.1 Earthquake-endangered areas

In earthquake-endangered areas, do not stack more than 3 devices on top of each other. Otherwise there is risk of injury due to falling devices or loose parts.

2.7.2 Explosive environment

Never use the system in potentially explosive atmospheres without appropriate protective equipment. For more information, contact the KNAUER Customer Support.

2.7.3 Cooling room

You may operate the device in a cooling room. To prevent condensation, note the following instructions:

- Allow the device to acclimatize for min. 3 hours before taking it into operation.
- After taking into operation, the device should stay switched on.
- Avoid temperature fluctuations.

2.7.4 Wet room

The device must not be operated in wet rooms.

2.8 Maintenance, care and repair

- Avoiding electric shock: Before performing any maintenance and service work, disconnect the device from the power supply.
- Tools: Use only tools recommended or prescribed by the manufacturer.
- Spare parts and accessories: Only use original parts and accessories made by KNAUER or a company authorized by KNAUER.
- PEEK fittings: Use PEEK fittings only for a single port or brand-new PEEK fittings in order to avoid dead volume or not exactly fitting connections.
- Column care: Follow KNAUER or other manufacturer's instructions on caring for the columns (see www.knauer.net/columncare)
- Used capillaries: Do not use any used capillaries elsewhere in the system in order to avoid dead volumes, not exactly fitting connections and spreading contamination.
- Safety features: The device may only be opened by the KNAUER Customer Support of KNAUER or any company authorized by KNAUER (see chapter 1.4.1 on page 2).
- For more information visit the KNAUER website: www.knauer.net/hplc-troubleshooting

2.9 Service request form and decontamination report

Devices which are shipped without the completed document "Service request form and decontamination report" will not be repaired. If you would like to return a device to KNAUER, make sure to enclose the completed document: www.knauer.net/servicerequest

3. Product information

Description The AZURA® Pump P 8.1L is suitable for analytical applications. The pump is used in an HPLC system or as a stand-alone device for conveying liquids. Liquids are pumped either with a constant flow or pressure. The flow rate and the pressure of the pump depends on the pump head.

3.1 AZURA® L features

AZURA® L-characteristics The device is a member of the AZURA® L product line and shares a number of features.

- The front cover serves as a protection for the device and its users, but can also be removed.
- The product is a stable device due to its large footprint and low centre of gravity.
- The leak tray on the front collects leaking fluids and protects the components from possible damage.
- The LEDs indicate the device status. This tells the user whether the device is working properly or whether an error has occurred.
- On the rear side you will find the power connection and further connections to control the device.

Identification The device name is above the serial number on the front. A silver sticker on the back gives information about the manufacturer (name and address), the product number and the specifications of the power supply.

3.2 Views

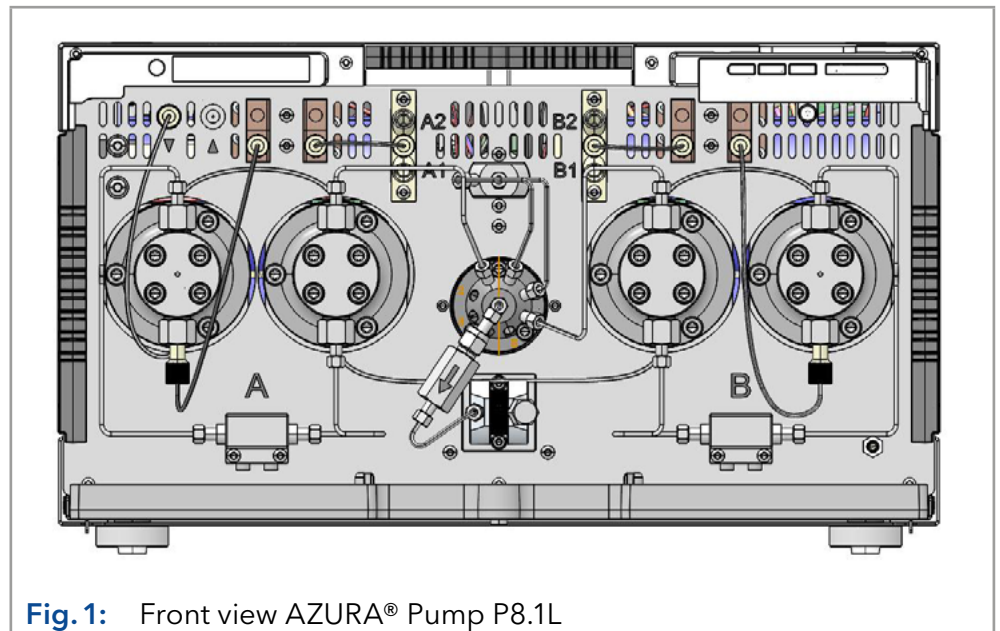
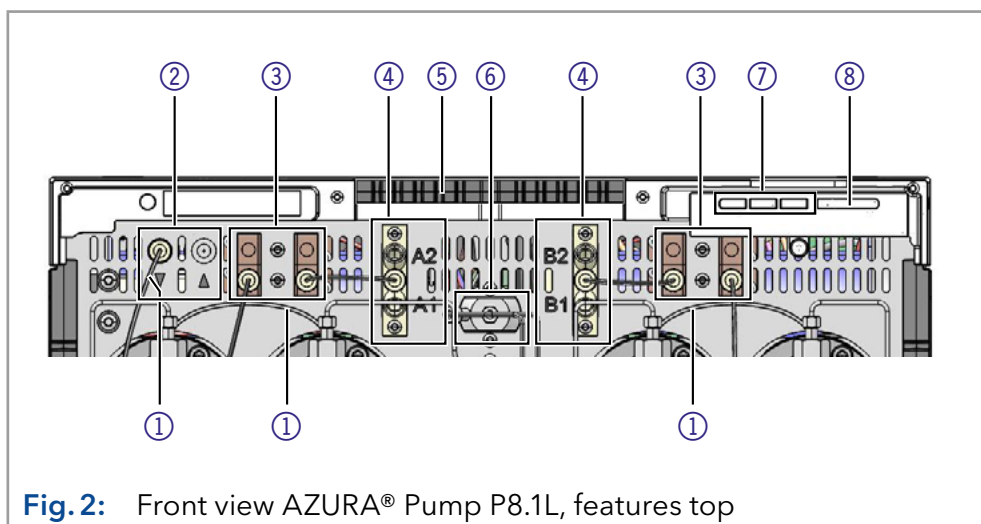

Fig. 1: Front view AZURA® Pump P8.1L

Legend

- ① Fluidics for piston backflushing
- ② Piston backflushing
- ③ Degasser
- ④ Solvent selection valve
- ⑤ Capillary guide
- ⑥ Pressure sensor
- ⑦ Status LEDs
- ⑧ Standby button

**Fig. 2:** Front view AZURA® Pump P8.1L, features top**Legend**

- ⑨ Capillary guide
- ⑩ Leak tray
- ⑪ Main piston
- ⑫ Pump head A
- ⑬ Auxiliary piston
- ⑭ Pressure sensor
- ⑮ Inline filter
- ⑯ Mixing chamber
- ⑰ Automated purge valve
- ⑱ Pump head B
- ⑲ Exhaust degasser

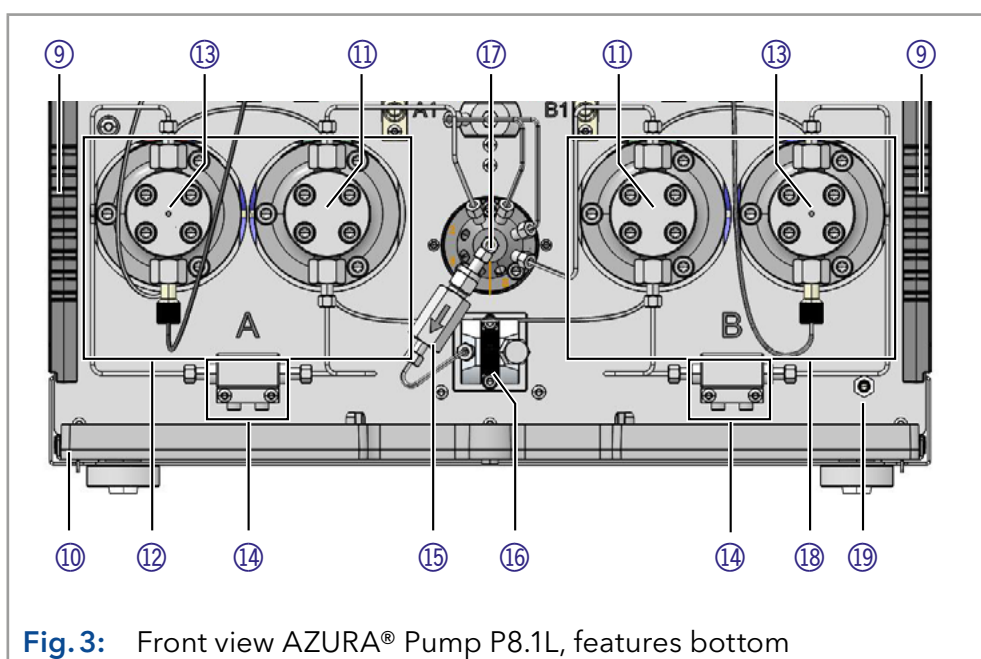
**Fig. 3:** Front view AZURA® Pump P8.1L, features bottom

3.2.1 Rear view

Legend

- ① Remote pin header
- ② Service interface
- ③ LAN connection 1 & 2
- ④ Event header
- ⑤ Fan
- ⑥ Symbols and signs (see chapter 3.5 on page 12)
- ⑦ Power switch and power connection

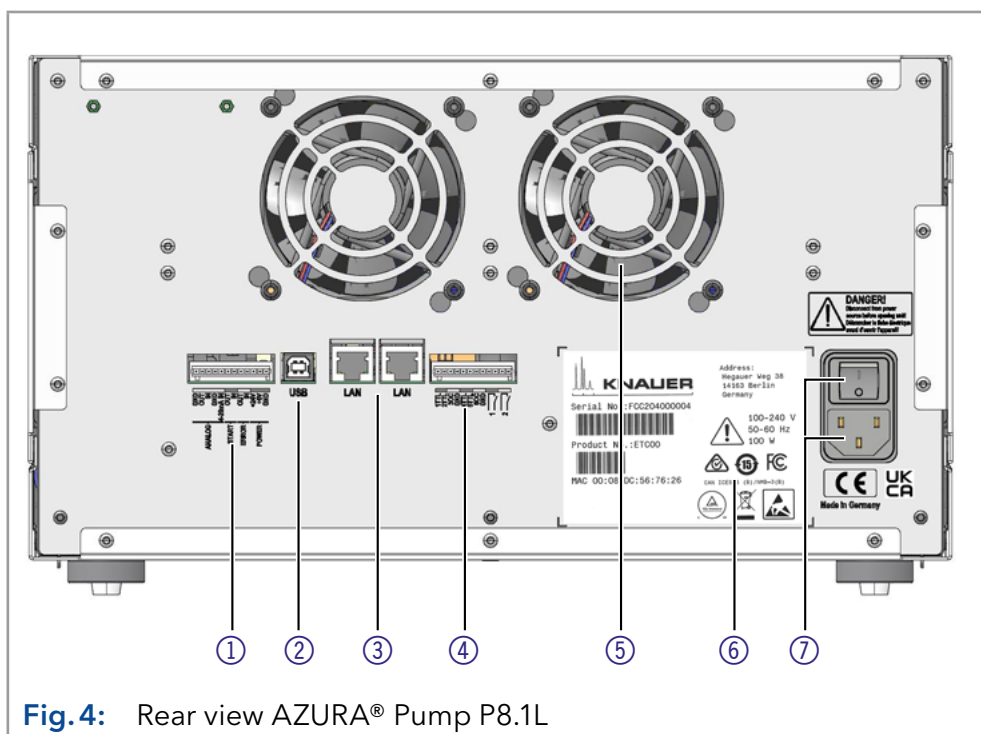

Fig. 4: Rear view AZURA® Pump P8.1L

3.3 Performance features

Pump head The pump head is equipped with an RFID chip. It is used to monitor and save all important parameters and settings. The RFID technology offers the following advantages:

- Software will automatically detect the parameters of the pump head
- Service-relevant data of the pump head will be saved

Mixing chamber The mixing chamber volume is 50 µl. The mixing chamber is interchangeable and can be replaced with a mixing chamber with a volume of 100 µl or 200 µl.

The necessary parameters for the mixing chamber are configured using the Mobile Control, or chromatography software.

Size: 50 µl, 100 µl, 200 µl

Pressure: 1240 bar

Piston backflushing The piston backflushing automatically flushes the rear piston area of the pump head upon switch-on and in operating mode.

- Upon switch-on: The rear piston area of the pump head is automatically flushed for 15 seconds.
- Operation: Every 15 minutes, the rear piston area of the pump head is flushed automatically for 15 seconds.

P_{Max} mode This mode protects the column bed against strong pressure fluctuations. If the maximum pressure is reached, the user can decide whether the pump is shut down or should continue running with a constant pressure.

You find a detailed description on the chromatography software in the corresponding user manual.

GLP data With the help of Mobile Control and various software packages (e.g. ClarityChrom® or OpenLAB®), it is possible to display or read the operating GLP data of the pump. You find a detailed description on how to display or read out GLP data in the corresponding instruction manuals.

Optional accessories As an additional accessory for operation, Mobile Control is available (see chapter 12 on page 66).

3.4 Scope of delivery



Note: Only use spare parts and accessories made by KNAUER or by a company authorized by KNAUER.











- AZURA® Pump P 8.1L
- Accessories kit AZURA® Pump P 8.1L (KNAUER order-no. FPF45)
 - AZURA Tubing Kit
 - Label A yellow ø 2.2 mm - 3.6 mm
 - Label 1 brown ø 2.2 mm - 3.6 mm
 - Label 2 red ø 2.2 mm - 3.6 mm
 - Label B yellow ø 2.2 mm - 3.6 mm
 - Tubing, FEP, 1/16" ± 0,05 mm OD x 0,5 mm ID
 - Sealing ring, PEEK, 1/16"
 - Nut PEEK for M2632 1/16" UNF 10-32
 - Fitting PEEK fingertight 1/16", 1/4-28 Super Flangeless
 - Ferrule Super Flangeless 1/16" PEEK with stainless steel ring, up to 172 bar for UNF 1/4-28
 - PTFE tube OD 1.6 mm, ID 0.9 mm
 - Biconical sealing ring
 - Dynaseal Screw, long, 1/16", stainless steel
- Accessories kit AZURA® (KNAUER order-no. FZA02)
 - A1467: 10-polar flat band cable, 1.5 m, AWG26 colored, cable 24
 - A96432: Drain nozzle for waste bottle
 - A9846-1: Well tubing, OD 10.2, 16 cm, ID 7.4, PE gray
 - A9846-2: Well tubing, OD 10.2, 21 cm, ID 7.4, PE gray
 - A9846-3: Well tubing, OD 10.2, 150 cm, ID 7.4, PE gray
 - M1246: WAGO micro lever latch 233/733 series
 - M1971: 12-pole connector, WAGO Micro 733-112
 - P6431: Drain funnel
 - P6432: Drain nozzle
 - A5255: Patch cable CATe, RJ45/RJ45 3m, blue
- Power supply cable

Valid documents:

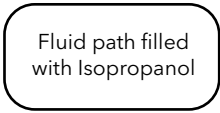
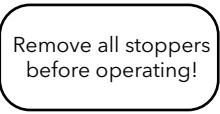
- Operating Instructions
- Declaration of Conformity
- Installation Qualification ("IQ")

3.5 Symbols and signs

The following symbols, labels and signs can be found on the device:

Symbol	Meaning
	Electric shock hazard. Failure to observe this warning may result in loss of life, serious injury or damage or destruction of the device.
	Electrostatic discharge hazard. Damages to system, device, or sensitive electronic components can occur.
	Obey maximum load for leak tray during transportation, installation and operation.
	A warranty seal is affixed to some devices. For more information (see chapter 1.4.4 on page 2).
	This sticker is located on the front of the pump.
	This sticker is located on the front of the pump. Remove stoppers from purge valve waste ports and mixer out port before operating.
	The device is covered by the Waste Electrical and Electronic Equipment Directive (WEEE Directive). It may not be disposed of as unsorted municipal waste and must be collected separately. For more information (see chapter 10 on page 63).
	The device fulfills the product specific requirements of European directives.
	The device complies with the product-specific requirements of the United Kingdom.
	The device has successfully passed the TÜV tests for quality and safety. The TÜV Germany is a nationally recognized testing agency (NRTL) in Canada and the USA.
	The electromagnetic interference from the device is below the limits approved by the Federal Communications Commission (FCC).
	The device complies with the Australian EMV regulations.

Symbol	Meaning
CAN ICES-3 (B)	The device complies with Industry Canada license-exempt RSS standards.



The device can be used for 15 years according to its intended use before there is a risk that the contained substances may escape and thereby pose a risk to the environment and health.

部件名称	有毒及危险物质或元素					
	铅	汞	镉	铬(VI)	多溴联苯	多溴二苯醚
印刷电路板	O	O	O	O	O	O
机电部件	O	O	O	O	O	O
电缆和电线	O	O	O	O	O	O
金属部件	X	O	O	O	O	O
塑料部件	O	O	O	O	O	O
电池	O	O	O	O	O	O
显示	n/a	n/a	n/a	n/a	n/a	n/a
O = 表示部件中所有同质金属中的有毒和危险物质含量低于SJ/T 11363-2006中描述的浓度极限要求。(表示部件中所有同质金属中的有毒和危险物质含量低于SJ/T 11363-2006中描述的浓度极限要求。*)						
X = 表示部件中所有同质金属中的有毒和危险物质含量超过SJ/T 11363-2006中描述的浓度极限要求。(表示部件中所有同质金属中的有毒和危险物质含量超过SJ/T 11363-2006*中描述的浓度极限要求。*)						

Part Name	toxic and hazardous substances or elements					
	Pb	Hg	Cd	Cr(VI)	PBB	PBDE
PCB	O	O	O	O	O	O
Electromechanical parts	O	O	O	O	O	O
Cables & wires	O	O	O	O	O	O
Metal Parts	X	O	O	O	O	O
Plastic parts	O	O	O	O	O	O
Batteries	O	O	O	O	O	O
Display	n/a	n/a	n/a	n/a	n/a	n/a
O = Indicates that the content of the toxic and hazardous substances in all homogenous Materials of the part is below the concentration limit requirements as described in SJ/T 11363-2006. (Indicates that the content of the toxic and hazardous substances in all homogenous Materials of the part is below the concentration limit requirements as described in SJ/T 11363-2006.*)						
X = Indicates that the content of the toxic and hazardous substances in all homogenous Materials of the part is exceeds the concentration limit requirements as described in SJ/T 11363-2006. (Indicates that the content of the toxic and hazardous substances in all homogenous Materials of the part is exceeds the concentration limit requirements as described in SJ/T 11363-2006.*)						

4. Installation and start-up

Before you specify the location, read the technical data (see chapter 11 on page 64). All device-specific information about electricity, environmental conditions and humidity is listed there.



Note: Only if the requirements for ambient conditions of the operating environment are met, the intended use can be ensured.

⚠ CAUTION

Bruising danger

The device could fall down and cause injury when carried, placed or installed.

- To carry or move the device, grasp the device only at the center of the side.
- Do not carry the device alone, but always with two people.

4.1 Unpacking

Process

Procedure

1. Set-up the package so that you can read the label.
2. Check the packaging, the device and accessories for transport damage.
3. Check the delivery scope. In case any parts are missing, contact the Technical Support.
4. If you lift, carry or move the device, make sure to grasp it from below with two people. Do not hold it on the front cover or the leak tray, as these parts are only loosely attached.

Next Steps

- Keep the attached list with the scope of supply for subsequent orders.
- Keep the original packaging for safe storage and/or transport of the device.

4.2 Ambient conditions

4.2.1 Location

Check the following requirements for the location, so the measurement results are unaffected:

- Place on a firm, level and even surface.
- Protect against direct sunlight.
- Do not expose to air drafts such as air conditioning systems.
- Do not set up next to other machines that cause floor vibrations.
- Keep from high frequency sources.
- Ensure adequate ventilation (see chapter 4.2.3 on page 15).
- Avoid temperature fluctuations (see chapter 4.2.2 on page 15).

4.2.2 Ambient temperature

If the ambient temperature of the device is abruptly changed (e.g. when it is installed in a cooling chamber), condensation will form inside the device and may cause damage to the device. Allow the device to acclimate for 3 h, before it is connected to the power supply and taken into operation.

4.2.3 Space requirements

- Make sure that the power plug on the power supply (wall socket or power strip) is always accessible, so that the device can be disconnected from the power supply.
- Ensure adequate ventilation around the device, otherwise it may overheat and malfunction may occur:
 - Min. 5 cm distance if another device is set on one side.
 - Min. 10 cm distance if further devices are set on both sides.
 - At least 15 cm to the cooler fan on the rear.
- The mounting of a small device to an AZURA L device with a mounting bracket does not affect the performance of either device. The space requirements specified in both device instructions do not apply in this case.

4.3 Power supply

Power supply requirements

- Failure-free power supply: For failure-free operation, the electrical voltage must be free of fluctuations, residual currents, voltage peaks and electromagnetic interference. The device must receive sufficient voltage and reserve capacity.
- Check voltage: Only connect devices to a power supply whose voltage corresponds to the permissible voltage of the device.
- Power consumption: The nominal power of the connected devices must not exceed 50 % of the highest connected power capacity, since higher currents can flow briefly when the device is switched on.
- Main connection: The electrical power supply at the operation site must be connected directly to the nearest main power connection.
- Grounding: The connectors for the voltage must be grounded accordingly.

Power supply cables and plugs

- Original parts: For power supply, use the supplied power cable and plug to meet the specifications (see chapter 11 on page 64). Detachable power cables are not allowed to be replaced with other cable types.
- Country-specific plugs: Before switching on the device, check whether the supplied plug is approved for your country. Overview of the devices- and country-specific plug types by KNAUER: www.knauer.net/plugs
- Power strips: If several devices are connected to one power strip, always consider the maximum power consumption of each device.

- Access to power supply: Make sure that the power plug on the power supply (wall socket or power strip) is always accessible, so that the device can be disconnected easily from the power supply.
- Damaged power supply cables and plugs: For safety reasons, damaged or faulty cables and plugs must not be used to connect the device to the power supply. Replace defective cables and plugs only with accessories from KNAUER.

4.4 Connecting the leak management

The leak management consists of a leak sensor and drainage system. The drainage system ensures that escaping liquids flow into a waste bottle. If there is too much liquid, the red LED starts flashing. Both the device and the data acquisition via chromatography software are stopped.

- Prerequisites**
- The front cover has been removed.

Procedure

Process

Figure

1. Carefully push the funnel ① into the center opening of the capillary guide ②.

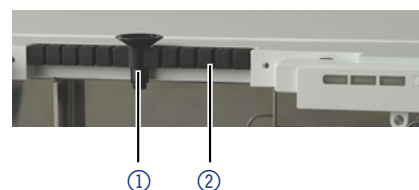

Fig. 5 Funnel and capillary guide

2. Push the long ending of the first nozzle ④ into the hose ③.

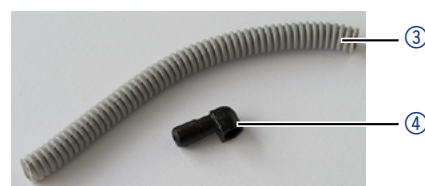

Fig. 6 Hose and nozzle

3. Afterwards, push the nozzle onto the funnel.
4. Push the other end of the hose onto the nozzle ⑤ of the leak tray.

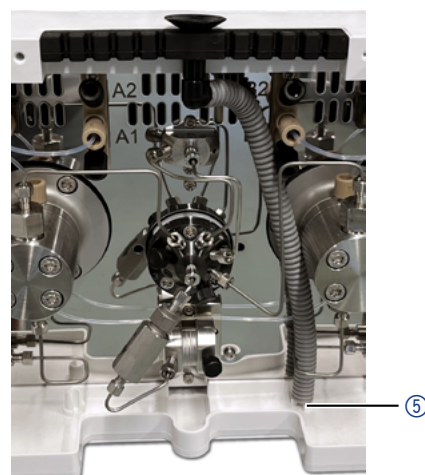

Fig. 7 Hose connected to device

Procedure	Process	Figure
	<ol style="list-style-type: none">5. Attach the waste nozzle ⑥ to the bottom unit6. Attach the waste tubing on the waste nozzle and connect it to the waste container.7. Place the waste container below the devices.	 <p data-bbox="997 443 1337 472">Fig. 8 Leak tray with nozzle</p>

Next steps ■ Attach the front cover.

4.5 Connecting the piston backflushing

Legend

- ① Piston backflushing inlet
- ② Piston backflushing outlet

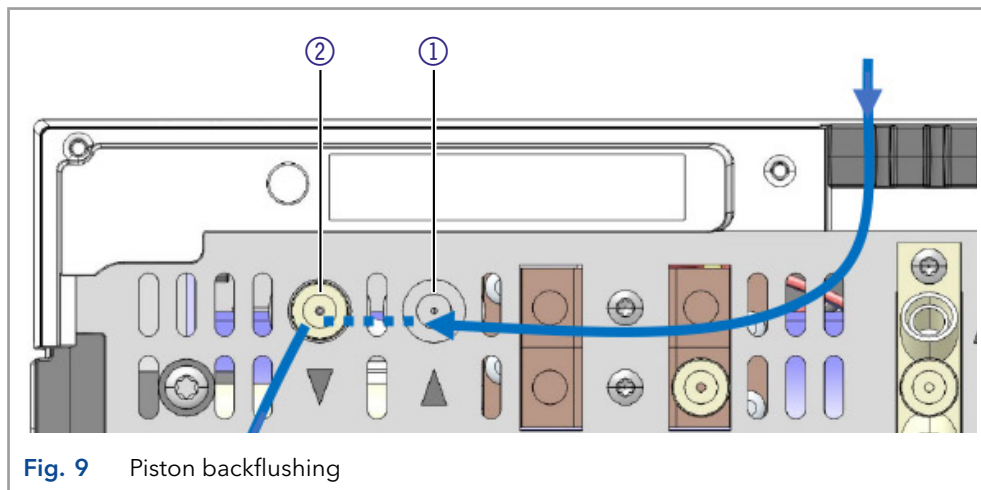

NOTICE

Component defect

Damage to flushing pump or tubings due to unsuitable eluents.

- Use the mentioned flushing eluents only.
- Renew the piston backflush solution once a week.

NOTICE

Device defect

Device defect due to intruding liquids.

- Use new capillary connections only, if leaks appear at the capillary fittings after maintenance or installation tasks.

The piston backflushing removes salts and other contaminating substances from the area behind the seals. For this purpose, a flushing solution bottle is connected with flush pump and piston backflushing. The silicone tube between the piston backflushing and the flush pump is pre-installed.

Functional principle

The piston backflushing function automatically flushes the rear piston area of the pump head upon switch-on and in continuous mode.

- Upon switch-on: The rear piston area of the pump head is automatically flushed for 15 seconds.
- In continuous mode: Every 15 minutes, the rear piston area of the pump head is flushed automatically for 15 seconds.

Flushing solution

Recommended flushing solutions:

- water
- mixture of 80 % water and 20 % ethanol
- isopropanol



Note: In applications with normal phase exclusively use isopropanol as a cleaning solution.

Designation

Inlet and outlet of the flush pump are located on the front of the device. The flush pump is located inside the device and is not visible.

Inlet symbol



Outlet symbol



- Prerequisites**
- The pump is installed at the operating location.
 - The pump has been switched off.

- Material**
- FEP tube

4.5.1 Procedure

Procedure

Process

1. Screw a FEP tube with UNF 1/4-28 flat bottom fitting into the flush pump inlet ① (refer to Fig. 10) Lead a tube to the solution bottle.
2. Attach another FEP tube with UNF 1/4-28 flat bottom fitting on the outlet of the flush pump ② . Then screw the end of the FEP tube with a conic 10-32 fitting from below into the lower bushing left-hand part of the pump head A ③ .
3. Connect the left part of the pump head A at the top ④ via a FEP tube to the top of the right part of the pump head A ⑤ . Use conical 10-32 fittings for this procedure.
4. Connect the right part of the pump head A at the bottom ⑥ with an FEP hose to the bottom of the left part of the pump head B ⑦ . Use conical 10-32 fittings for this procedure.
5. Connect the left part of the pump head A at the top ⑧ via an FEP tube to the top of the right part of the pump head A ⑨ . Use conical 10-32 fittings for this procedure.
6. Connect a FEP tube with a conical 10-32 fitting at the bottom of the right part of the pump head B ⑩ . Lead the end of the tube back to the flushing solution bottle.

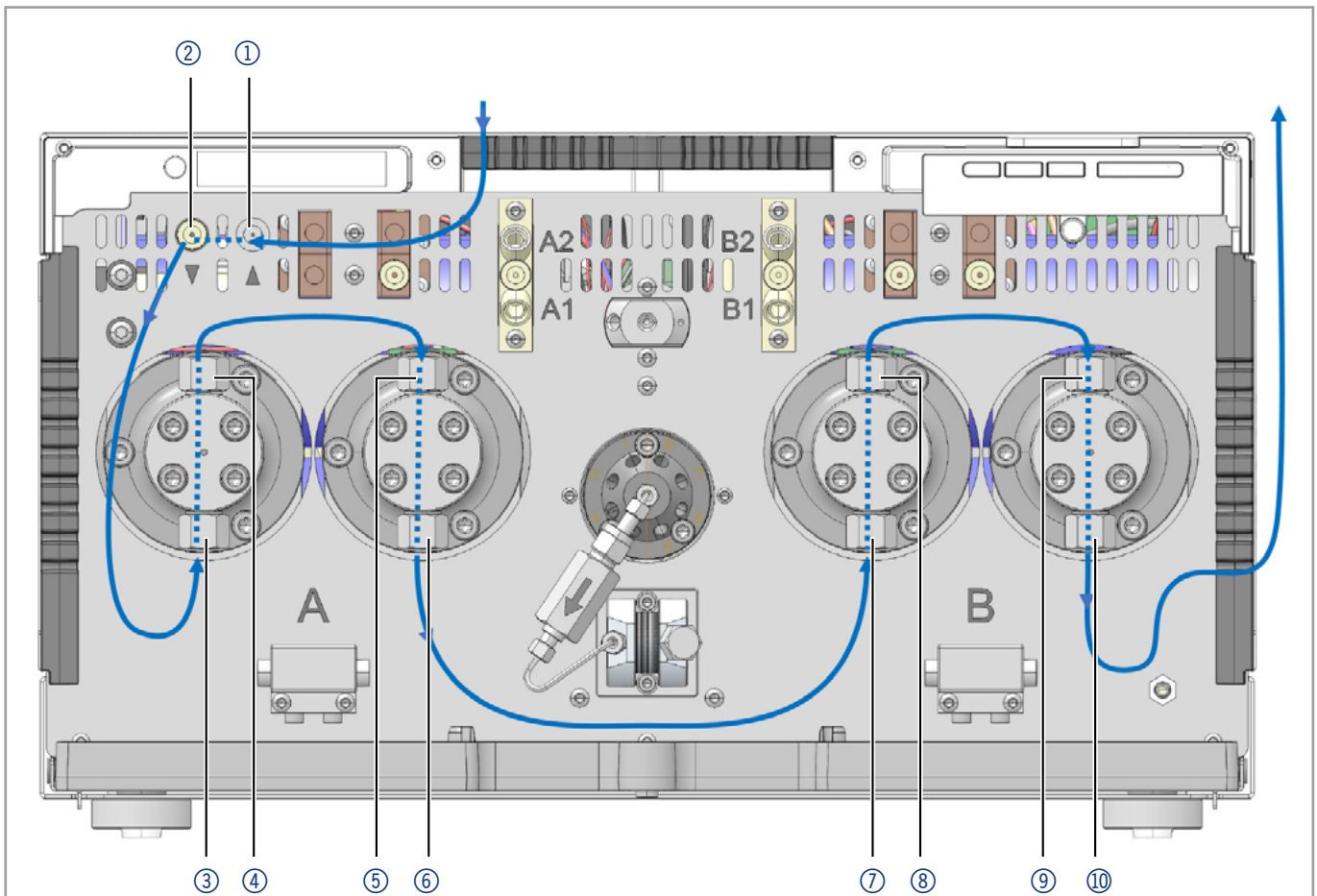

Fig. 10 Connection piston backflushing

Legend

- ① Flush pump inlet
- ② Flush pump outlet
- ③ Lower bushing of the left part of pump head A
- ④ Upper bushing of the left part of pump head A
- ⑤ Upper bushing of the right part of pump head A
- ⑥ Lower bushing of the right part of pump head A
- ⑦ Lower bushing of the left part of pump head B
- ⑧ Upper bushing of the left part of pump head B
- ⑨ Upper bushing of the right part of pump head B
- ⑩ Lower bushing of the right part of pump head B

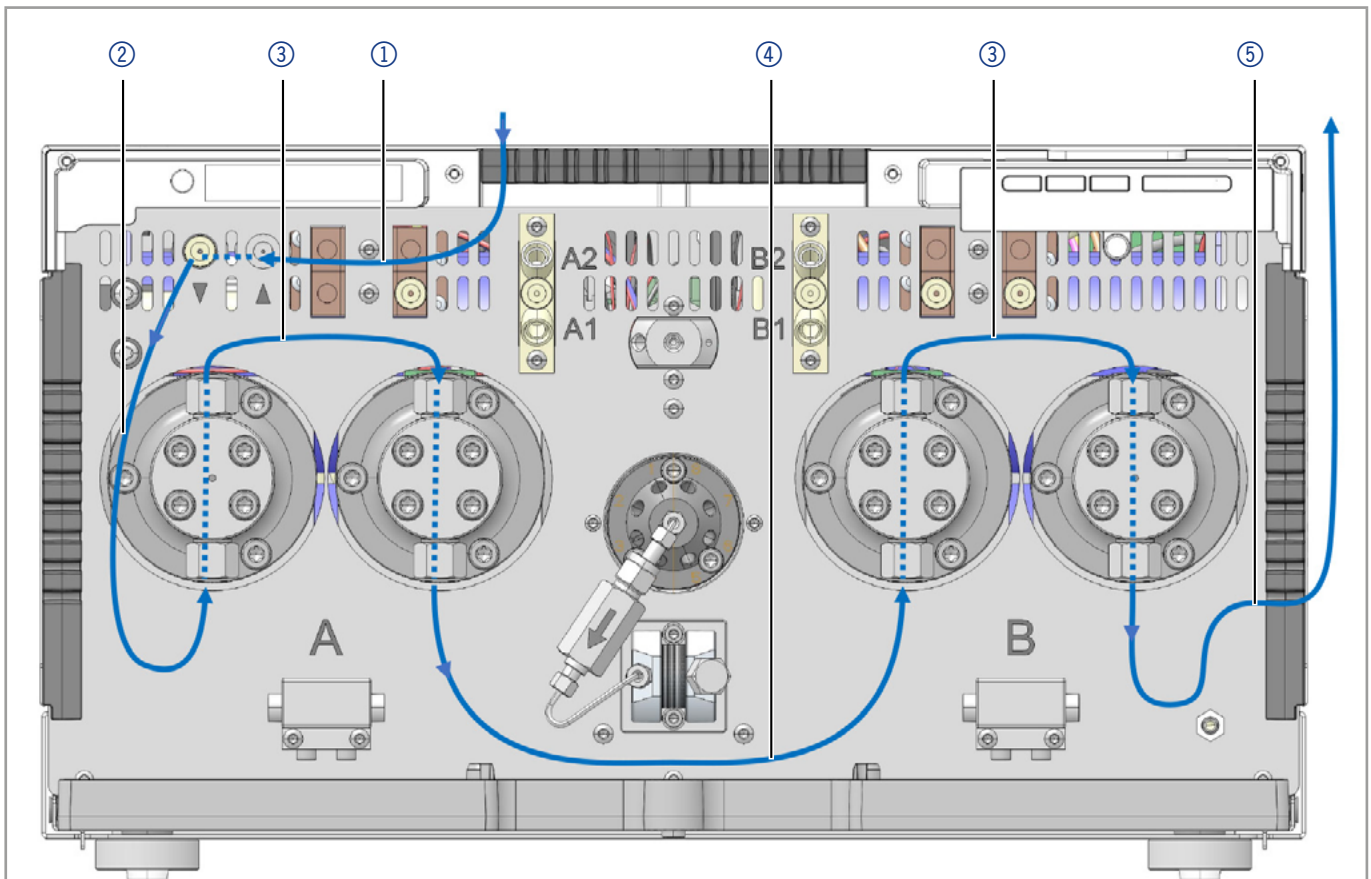

Fig. 11 Flow path piston backflushing

Legend

- ① Inlet from flush pump to piston backflushing
- ② Connection from piston backflushing to inlet pump head A
- ③ Connection between pump head pistons
- ④ Connection between outlet pump head A and inlet pump head B
- ⑤ Connection from outlet pump head B to waste bottle

4.6 Connecting the capillaries

Marking At the time of delivery, some tubings and capillaries are already pre-installed. These pre-installed stainless steel and PEEK capillaries are color-coded according to their inner diameter.

Color	Material	Inner Diameter
red marker	stainless steel	0.1 mm
blue marker	stainless steel	0.25 mm
black marker	stainless steel	0.45 mm
red stripes	PEEK	0.1 mm
blue stripes	PEEK	0.25 mm
orange stripes	PEEK	0.5 mm

Eluent bottles You only need to connect the eluent bottles. For the connection of the eluent bottles, tubes with built-in eluent filters are used. The tubes have to be screwed onto the device with flangeless fittings.



Note: Tools may damage the fitting. Tighten the fitting finger tight.



Note: PEEK capillaries are not suitable for use with pure acetonitrile. Acetonitrile can cause capillaries to crack or rupture.

Procedure

Process

- Slide the flangeless fitting ① over the tube.
- Slide the fixation ring ② over the tube, then put on the sealing ring ③. Note the direction of the fixation ring, otherwise the seal ring will be damaged. The broad side of the fixation ring should point into the direction of the fitting.
- Screw the assembled flangeless fitting ④ onto the device by hand.

Figure

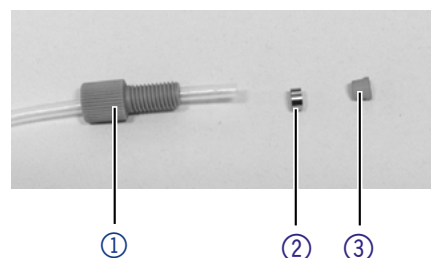

Fig. 12 Structure of flangeless fitting

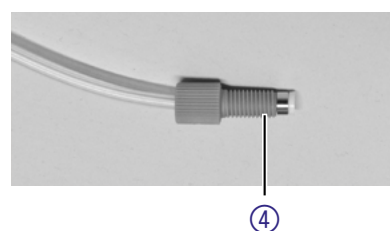

Fig. 13 Fully assembled flangeless fitting

4.7 Integrating the pump into a system



Note: Note at all times the ambient conditions found in the section "Technical data", as well as the ambient conditions of other devices to be integrated into the system.

NOTICE

Component defect

Damage to components due to excessive tightening possible.

Observe the torque of the screw connection

→ Use 5 Nm torque for stainless steel fittings.

The pump is integrated into the HPLC flow system by connecting a capillary to the mixing chamber and the HPLC system.

Tools ■ Torque wrench

4.7.1 Connecting capillaries and tubings

Fig. 14 shows the installation diagram for connecting capillaries and tubings to the pump.



Note: Most of the tubings and capillaries shown here are already pre-installed. An exception is the inlet of the eluent bottle to the solvent selection valve (see ① Fig. 14).

Piston backflushing

The flushing solution is re-used. Since the flow path is circular, only one bottle is required for the flushing solution.

Each pump head can be operated optionally with two different eluents. Both eluents are connected to the solvent selection valve. The eluents are led from the degasser in one pump head for each and then are merged in the pressure sensor. The pressure sensor is connected with the automatic purge valve. The automatic purge valve leads the eluent into the mixing chamber which is connected to the HPLC system.

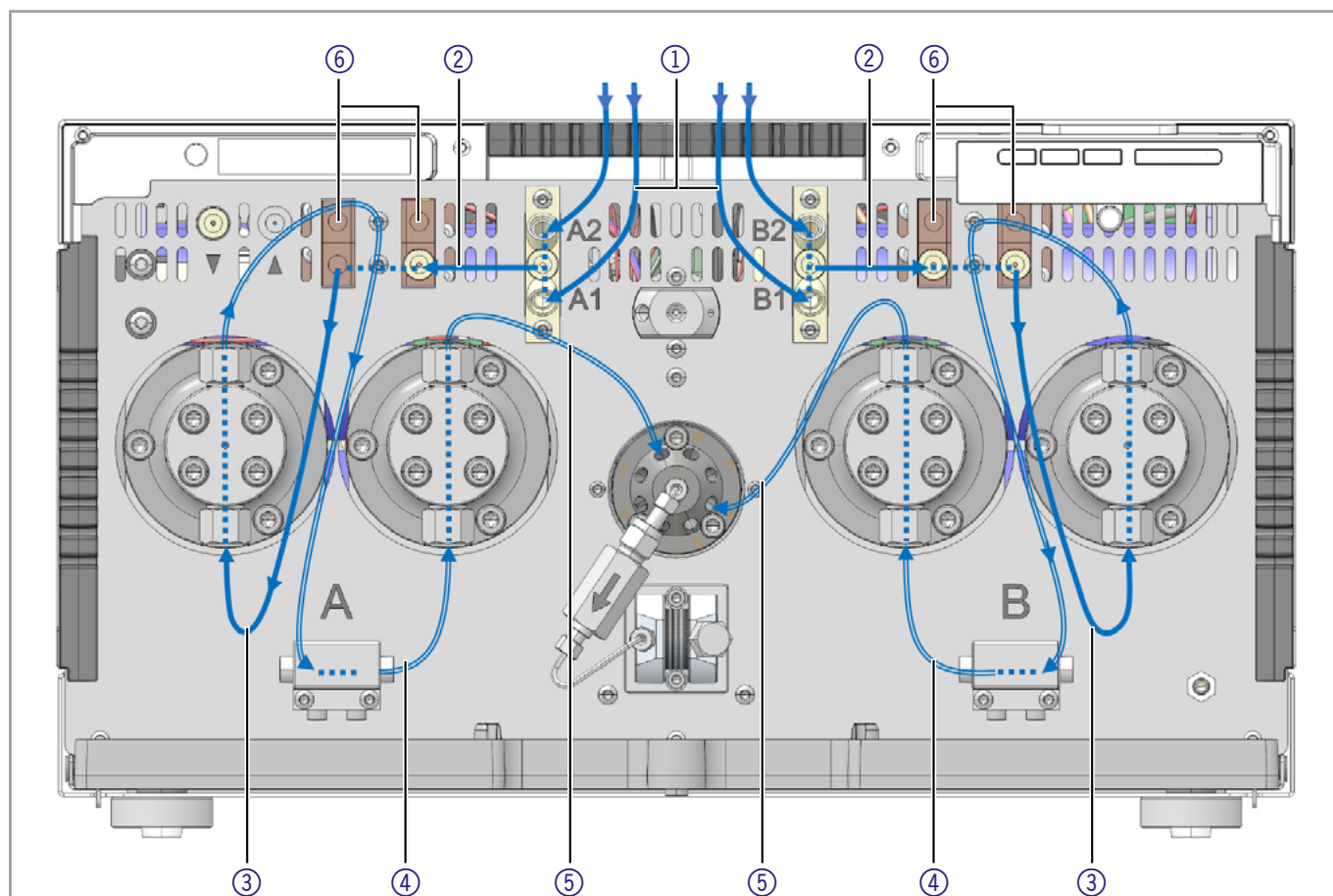

Fig. 14 Flow path variant

Legend

- ① Inlet of eluent bottle to solvent selection valve
- ② Inlet of solvent selection valve to degasser
- ③ Connection from degasser to pump head inlet
- ④ Connection between pump head pistons
- ⑤ Connection from pump head to purge valve
- ⑥ Degasser channels for degassing the flushing liquids of the autosampler

4.7.2 Connecting the degasser

The inlet of the degasser ② is already connected with the solvent selection valve upon delivery ① (see Fig. 14). The outlet of the degasser ③ is already connected with the pump heads upon delivery (see Fig. 9).

Eluent flow path

The two eluents are connected with the inlet of the degassers ②. The eluent from the degasser is led in the pump head and then runs via the pressure sensor into the mixing chamber which is connected to the HPLC system.



Note: The described flow path is not suitable for normal phase.

Next Steps You can integrate the pump into the system.

4.7.3 Connecting the solvent selection valve to eluent



Note: The solvent selection valve is already connected with the 2-channel degasser upon delivery.

The solvent selection valve allows each eluent channel to choose between two different solvents, without having to reconnect any tubing. For the two eluent channels A and B, one of two eluents can be selected separately. The eluent A is connected to the ports A1 and A2, the eluent B to ports B1 and B2.

- Prerequisites**
- The device has been switched off.
 - The power plug has been pulled.
 - The front cover has been removed.

- Material**
- Flangeless fitting

Procedure

Process

1. Connect the tubing from the four eluent bottles at the ports A1, A2 ①, as well as B1, B2 ②.
2. Close unused connections with plugs.

Figure

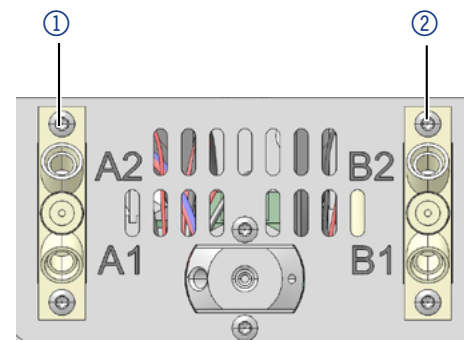

Fig. 15 Solvent selection valve

- Next steps** Integrate the pump into the system.

4.7.4 Connecting the purge valve



Note: The pump heads as well as the pressure sensor are already connected to each other upon delivery.

After the start, the purge valve allows the pump automatically to flush without manual intervention, e. g. to remove air from the suction tube. The flow paths during flushing are shown in Fig. 16.

Fig. 17 shows the path during an analysis.

Prerequisites

- The device has been switched off.
- The power plug has been pulled.
- The front cover has been removed.

Material

- Fittings
- Capillaries
- PTFE tube
- Open-end wrench

Procedure

Process

1. Connect the capillary from the outlet of the pump head A at position 1 of the purge valve

2. Connect the capillary from the outlet of the pump head B at the position 6 of the purge valve.

3. Connect the pressure sensor with the two capillaries on the positions 7 and 8 of the purge valve (Fig. 16).

4. Connect the purge valve via the central bore hole with a capillary to the mixing chamber.

5. Connect a tube for waste to the positions 2 and 5 of the purge valve.

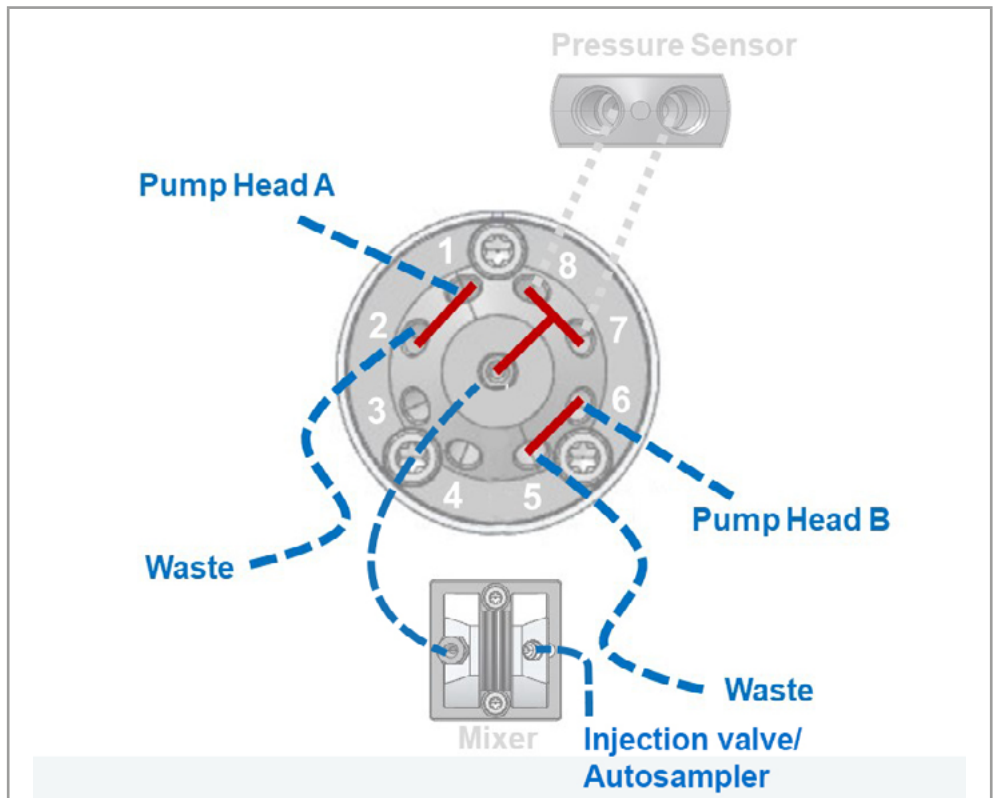

Fig. 16: Valve position Start/Purge

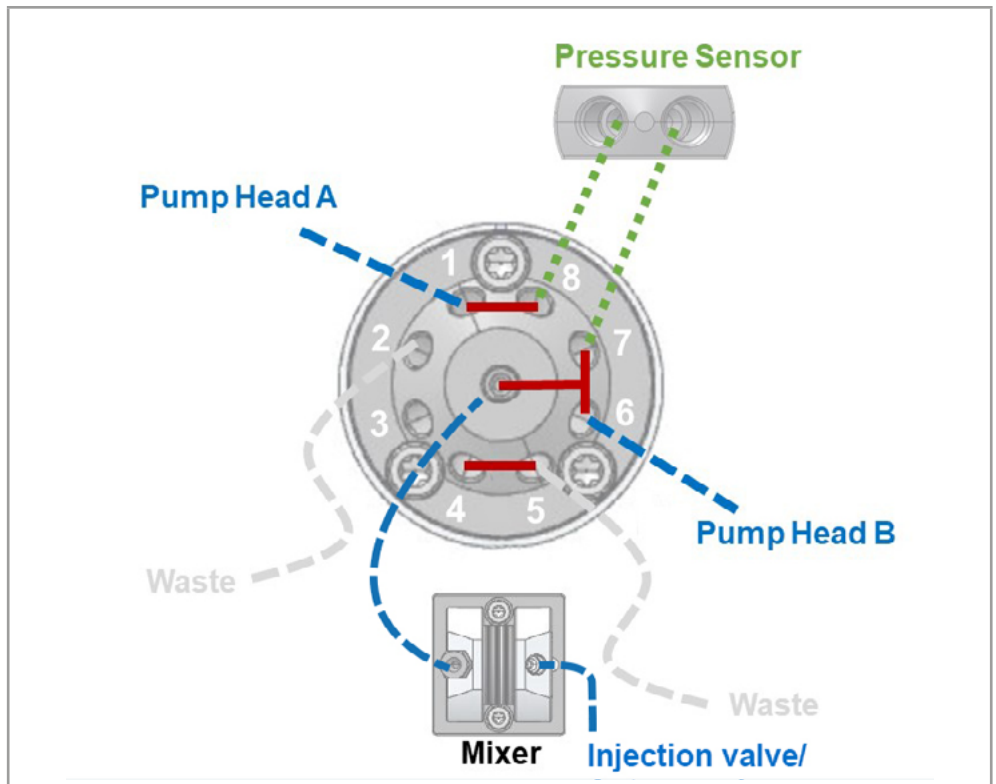

Fig. 17: Valve position Run

4.8 Computer control



Note: HPLC devices from KNAUER only work with IP addresses, which have been assigned by IPv4. IPv6 is not supported.

This chapter describes how to set up a chromatography system in a local area network (LAN) and how a network administrator can integrate this LAN into your company network. The description applies to the operating system Windows® and all conventional routers.

To assign an IP address to the device, it must be connected to a LAN network. The two LAN ports of the device can be connected to the PC and/or to another device as desired. Note that the other device can in turn be connected to a third device, and so on, so that you can connect several devices in succession (cascade).

Never connect both ports to the same PC/device or close a ring. At the end of the chain, you can also connect a device with only one LAN port. All devices connected in this way can be controlled individually via the PC if they have an IP address from the same network range as the PC. However, none of the devices in this chain may be switched off, otherwise communication will be interrupted.

Via Mobile Control you can either assign the IP address manually or set the device to DHCP (obtain dynamic IP address). Furthermore, all devices with AZURA Neo can obtain an IP address via the „routerless“ APIPA service.



Note: When using PurityChrom®, static IP addresses are needed (see chapter 4.9 on page 31).

4.8.1 Setting up LAN

To set up a LAN, we recommend to use a router. That means the following steps are required:

Process

Procedure

1. On the computer, go to the control panel and check the LAN properties.
2. Hook up the router to the devices and the computer.
3. Set up the router for the computer network.
4. Install the chromatography software.
5. Switch on the device and run the chromatography software.

Next steps

Configure LAN properties (see section 4.8.2).

4.8.2 Configuring LAN settings

The LAN uses only one server (which is normally the router) from that the devices automatically receive their IP address.

Prerequisites

- In Windows, power saving, hibernation, standby, and screen saver must be deactivated.

- In case you use an USB-to-COM box, the option "Allow the computer to turn off this device to save power" in the Device Manager must be deactivated for all USB hosts.
- Applies to all LAN devices: Disable the setting for the network adapter in Device Manager "Allow the computer to turn off this device to save power".

Process

Procedure

1. In Windows, open <Network and Sharing Center>.
2. Double-click on <LAN connection>.
3. Click on the button <Properties>.
4. Select <Internet Protocol version 4 (TCP/IPv4)>.
5. Click on the button <Properties>.
6. Check the settings in the tab <General>. The correct settings for the DHCP client are:
 - a) Obtain an IP address automatically
 - b) Obtain DNS server address automatically
7. Click on the button <OK>.

Next steps Connect devices (see section 4.8.3).

4.8.3 Connecting devices with LAN

A router ② has several LAN ports ③ and one WAN port ④ that can be used to integrate the LAN into a wide area network (WAN), e.g. a company network or the Internet. In contrast, the LAN ports serve to set up a network from devices ① and a computer ⑤. To avoid interference, we recommend operating the chromatography system separately from the company network.



Note: You will find patch cables for each device and the router in the accessories kit. To connect the router to a LAN, an additional patch cable is required, which is not supplied within the scope of delivery.

Legend

- ① Devices
- ② Router
- ③ LAN ports
- ④ WAN/Internet connection
- ⑤ Computer

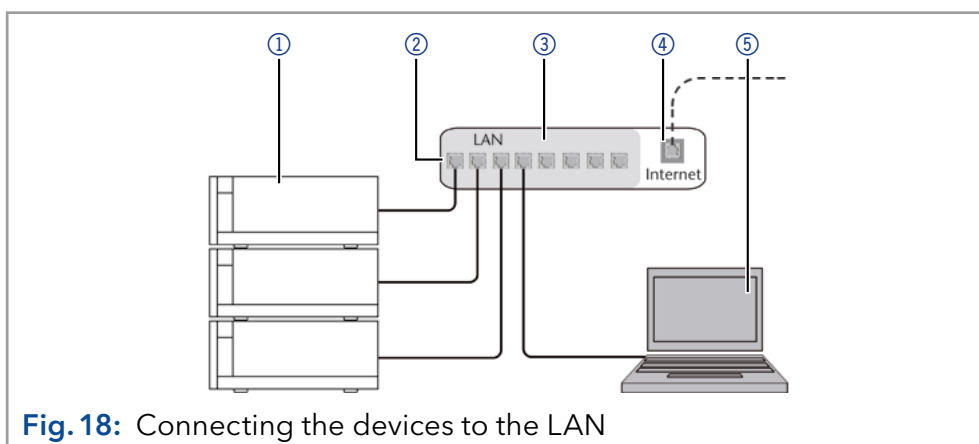

Fig. 18: Connecting the devices to the LAN

Prerequisites

- The computer is switched off.
- There is a patch cable for each device and the computer.

Process

- Procedure**
1. Use the patch cable to connect the router and the computer. Repeat this step to connect all devices.
 2. With additional patch cables, connect all devices individually with the router.
 3. Use the power supply to connect the router to the mains power system.

Next steps Set the router properties (see section 4.8.4).

4.8.4 Configuring the router

The router is preset at the factory. Information about address, user name and password is noted in the router manual: www.knauer.net/router.

Process

- Procedure**
1. To open the router configuration, start your Internet browser and enter the IP address (does not apply for all routers).
 2. Enter user name and password.
 3. Configure the router as DHCP server.
 4. In the router configuration, check the IP address range and make changes if necessary.



Note: If the IP address range has been changed, it is essential to note this information on the router.

Result Once the router has assigned IP addresses to all devices, the chromatography software can be used to remotely control the system.

4.8.5 Integrating LAN into the company network

A network administrator can integrate the LAN into your company network. In this case you use the WAN port of the router.

Prerequisites

- There is a patch cable for the connection.

Process

- Procedure**
1. Make sure that there is no overlap between the IP addresses of the router and the corporate network.
 2. In case of an overlap, change the IP address range of the router.
 3. Use the patch cable to connect the router WAN port to the company network.
 4. Restart all devices, including the computer.

Result The LAN is now integrated into the company network.

4.8.6 Controlling several systems separately in LAN

Devices connected to a LAN communicate through ports, which are part of the IP address. If more than one chromatography systems are connected to the same LAN and you plan on controlling them separately, you can use different ports to avoid interference. Therefore, the port number for each device must be changed and this same number must be entered into the device configuration of the chromatography software. We recommend to use the same port number for all devices in the same system.



Note: The port is set to 10001 at the factory. You must use the same numbers in the device configuration of the chromatography software as in the device, otherwise the connection fails.

Process

Procedure

1. Find out port number and change it on the device.
2. Enter the port number in the chromatography software.

Result

The connection is established.

4.9 Setting IP addresses via software



Note: Check the IT security standards for your lab before intervening in the LAN settings.

For Mobile Control and Firmware Wizard, it is possible to set a fixed (static) or dynamic (DHCP) IP address via software.

4.9.1 Mobile Control: Setting a static IP address



Note: The device is preset to a dynamic address (DHCP). To ensure a constant LAN connection between the chromatography software and the instrument, we recommend switching the instrument to a static IP address for certain applications. For more information on LAN settings, please refer to the Mobile Control Software manual, which can be downloaded from the KNAUER website <https://www.knauer.net/mobile-control-downloads> in section "downloads/manuals".

Prerequisites

- The device is switched on.
- Mobile Control is installed and running.
- The connection between Mobile Control and the device has been established.

Process

Procedure

1. In Mobile Control, click <Settings>.
2. On the <General> tab, choose the device name.
3. In <Network Settings>, choose the setting <Static> ①.
4. Enter the IP address into the text box <IP Address> ②.
5. If necessary, change the subnet mask and the gateway ③.

Process

6. Click **Apply** in the top right corner.
7. Restart the device (recommended).

Legend

- ① IP address mode
- ② Text box for IP address
- ③ Text field for subnet mask/gateway

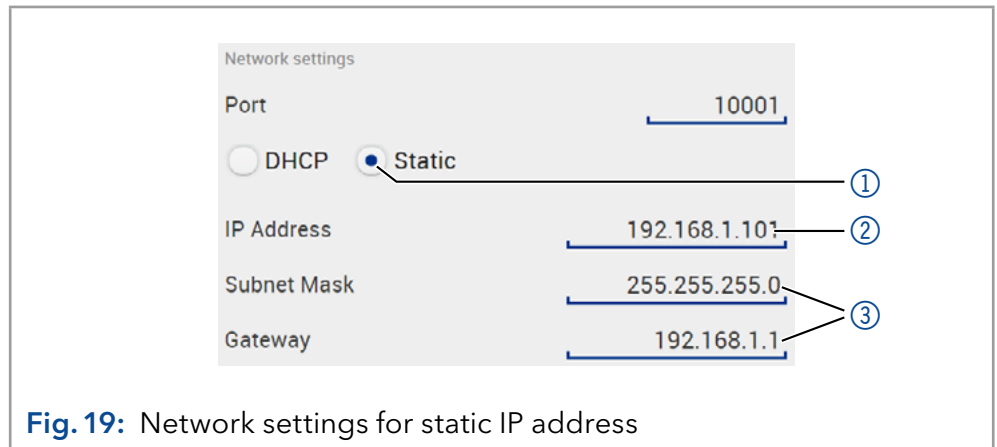

Result The device is now accessible via the static IP address.

4.9.2 Mobile Control: Setting a dynamic IP address via device name

- Prerequisites**
- The device is switched on.
 - Mobile Control is installed and running.
 - The connection between Mobile Control and the device has been established.

Process

- Procedure**
1. In Mobile Control, click <Settings>.
 2. On the <General> tab, choose the device.
 3. In <Network Settings>, choose the setting <DHCP> ①.
 4. Click **Apply** in the top right corner.
 5. Restart the device (recommended).

Legend

- ① IP address mode

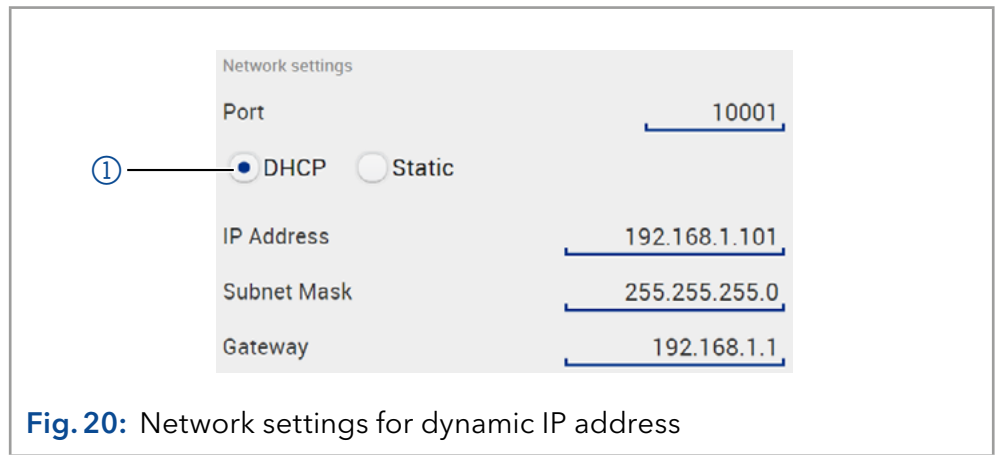

Result The device is now accessible via a dynamic IP address.

4.9.3 Mobile Control: Setting a dynamic IP address via device serial number

- Prerequisites**
- The device is switched on.
 - Mobile Control is installed and running.
 - The connection between Mobile Control and the device has been established.

Process

- Procedure**
1. In Mobile Control, click <Settings>.
 2. In <Network Settings>, click <Reset>. The windows <Reset communication settings> opens.
 3. Enter the serial number of the device into the text field.
 4. Click <OK>. The device is now reset to default settings.
 5. Restart the device (recommended).

Result The device is now accessible via a dynamic IP address.

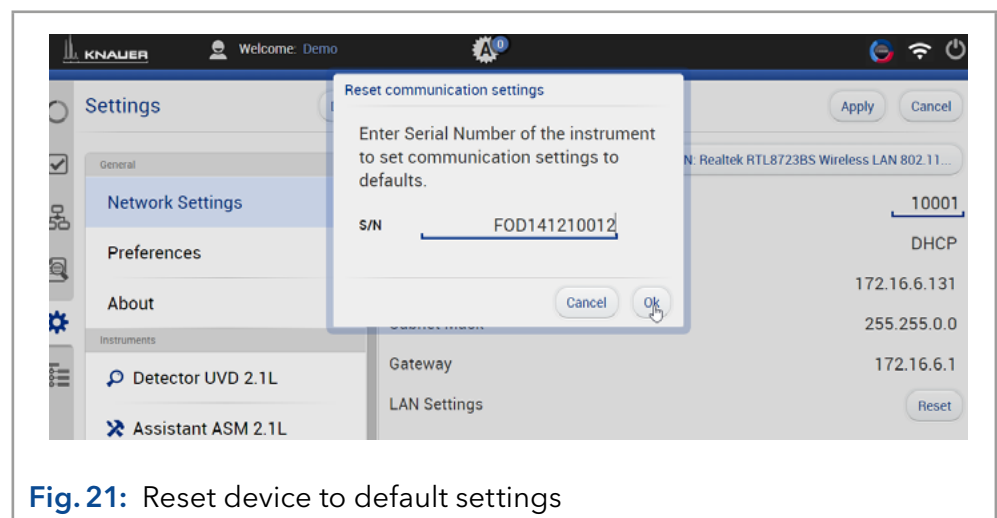

4.9.4 Firmware Wizard: Setting a static IP address



Note: More information about LAN settings can be found in the Mobile Control Software Instructions in the chapter "Firmware Wizard" (document no. V6851-2).

Legend

- ① Text box for serial number of the device
- ② Setting IP address manually
- ③ Text box for IP address
- ④ Text box for subnet mask & gateway
- ⑤ Confirm changes

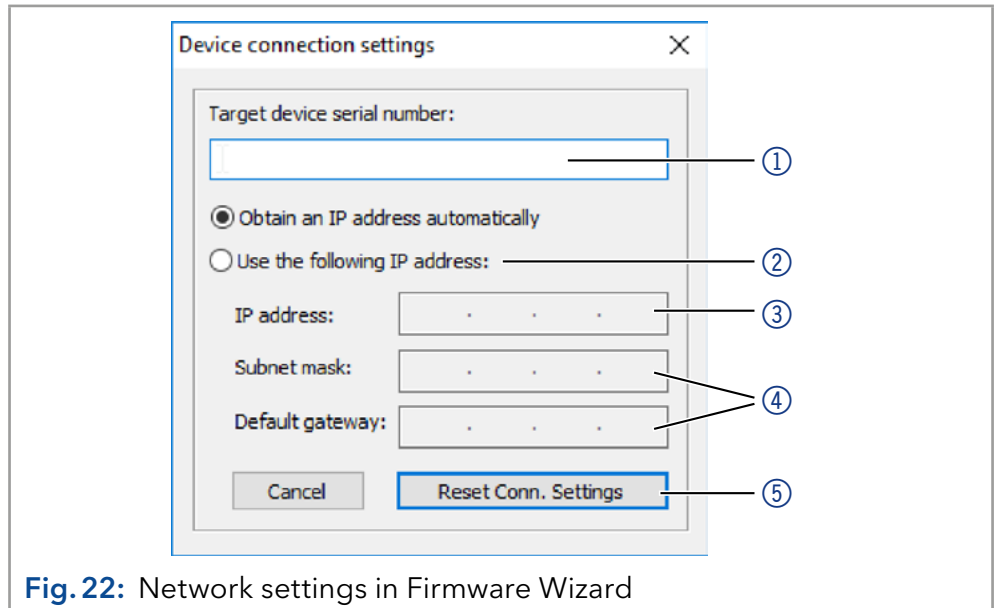

Fig. 22: Network settings in Firmware Wizard

- Prerequisites**
- The device is switched on.
 - Firmware Wizard is installed and running.

Process

- Procedure**
1. In Firmware Wizard, click <Reset LAN Settings...>.
 2. The window <Device connection settings> opens. Enter serial number of the device into the text field <Target device serial number> ①.
 3. Select option <Use the following IP address> ②.
 4. Enter the IP address into the text field <IP address> ③.
 5. Optionally, adjust subnet mask and gateway ④.
 6. Click <Reset Conn. Settings> ⑤ to accept changes.
 7. Restart the device (recommended).

Result The device is now accessible via the static IP address.

4.9.5 Firmware Wizard: Setting a dynamic IP address

- Prerequisites**
- The device is switched on.
 - Firmware Wizard is installed and running.

Process

- Procedure**
1. In Firmware Wizard, click <Reset LAN Settings...>.
 2. The window <Device connection settings> opens. Enter serial number of the device into the text field <Target device serial number> ①.
 3. Select option <Obtain an IP address automatically> ②.
 4. Click <Reset Conn. Settings> ⑤ to accept changes.
 5. Restart the device (recommended).

Result The device is now accessible via a dynamic IP address.

4.9.6 Setting a static IP address via APIPA

APIPA is a service that allows devices to obtain a dynamic IP address even without a DHCP server in the network. The AZURA Neo platform from KNAUER supports APIPA. The device must be set to DHCP for this. If no DHCP server responds, the APIPA implementation ensures that the device gives itself a random IP address from the IP address range reserved for APIPA (169.254.x.x). This ensures that 2 devices do not use the same IP address. This process can take several minutes. At each reboot the device will use a different APIPA IP address.

Since Windows also supports APIPA, if the setting for the IP address (IPv4) is set to „Obtain automatically“, a connection to the device can be established via this even without a router or fixed IP addresses. It is not recommended to use APIPA in general to establish a connection for device control by chromatography software.

AZURA® Neo Via Mobile Control, you can set the IP address either manually or via DHCP (see previous chapters). In addition, all devices with AZURA® Neo can be set via “routerless” APIPA configuration.

To set an IP address via APIPA configuration, the PC and the LAN control must be set to DHCP mode. If no DHCP server is detected, the device switches to the APIPA configuration and automatically receives an IP address. This process may take a few minutes.

4.10 Remote control

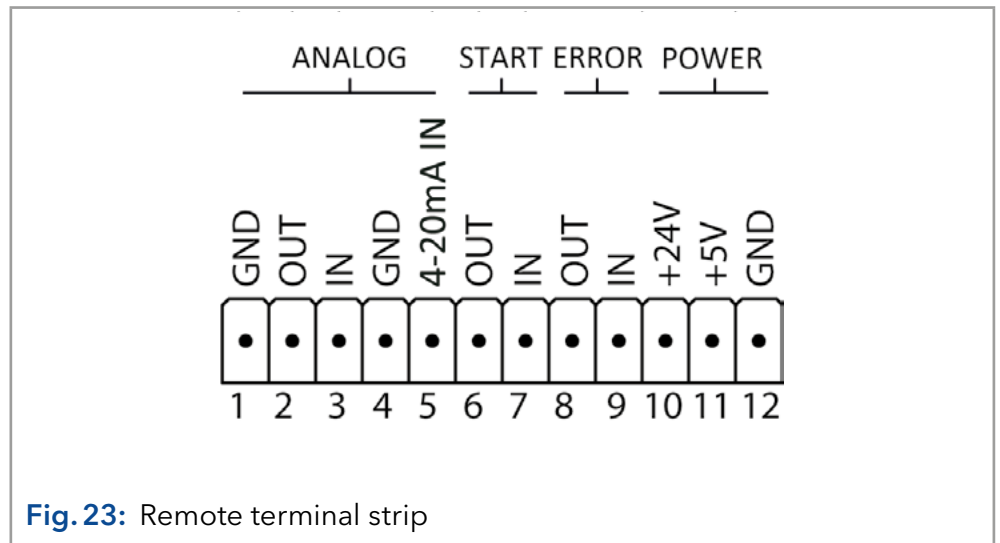





Fig. 23: Remote terminal strip

4.10.1 Connector assignment

Signal	Explanation
Analog GND	Reference point of the voltage at the signal inputs.
Analog out	Voltage range 0 - 5 V, scalable
Analog in	For Service only!
Analog GND	Reference point of the voltage at the signal inputs.
Analog 4-20 mA IN	For Service only!
Start OUT	TTL Output Levels: <ul style="list-style-type: none"> passive 5 V  active 0V 
Start IN	TTL-compatible input <ul style="list-style-type: none"> Low-active Secure switching threshold at least 10 mA After receiving a signal (short-circuit to ground) from an external device, the device starts. If controlled with software, an electronic trigger is send through the LAN.
Error OUT	TTL Output Levels: <ul style="list-style-type: none"> passive 5 V  active 0 V 

Signal	Explanation
Error IN	TTL-compatible input <ul style="list-style-type: none"> Low-active Secure switching threshold at least 10 mA After receiving a signal (short-circuit to ground) from an external device, an error message appears and the device stops.
+24V	Event-controlled switching of 24 V against GND Protection: 24 V-200 mA
+5V	Provides a voltage of 5 V with respect to GND. This makes it possible to supply a consumer that is switched by an EVENT. Protection: 5 V-50 mA
GND	Reference point of the voltage at the signal inputs.

4.10.2 Events connector

For test purposes or in some other cases, it can make sense to manually enter these signals:

- sending control signals (Events) to external devices
- opening and closing contacts
- activating 500 ms pulses

Legend

- ① Display
- ② Events connector

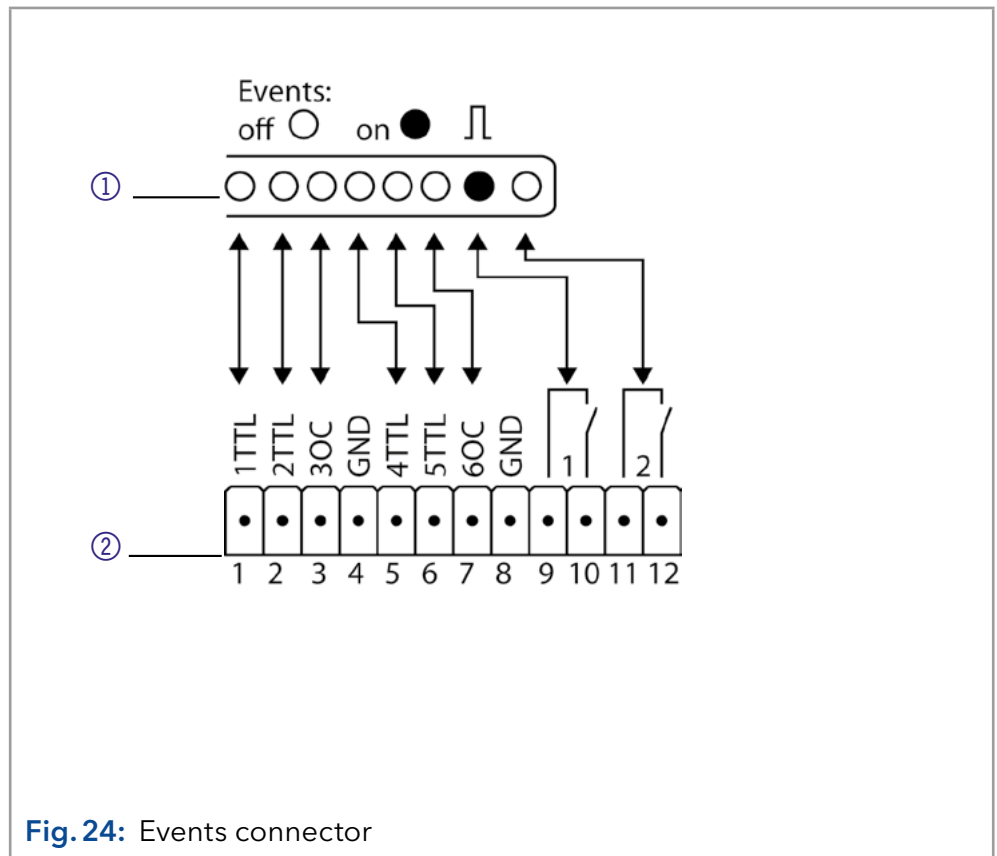



























Fig. 24: Events connector

Assignment	Connection	Function
1TTL		TTL Output Levels: <ul style="list-style-type: none"> passive 0 V  active 5 V  Pulse: <ul style="list-style-type: none"> 5 V for at least 1000 ms 
2TTL		TTL Output Levels: <ul style="list-style-type: none"> passive 0 V  active 5 V  Pulse: <ul style="list-style-type: none"> 5 V for at least 1000 ms 
3OC		TTL-compatible output Levels: <ul style="list-style-type: none"> passive 5 V  active 0 V  Pulse: <ul style="list-style-type: none"> 5 V for at least 1000 ms 
GND		Reference point of the voltage at the signal inputs.
4TTL		TTL Output Levels: <ul style="list-style-type: none"> passive 0 V  active 5 V  Pulse: <ul style="list-style-type: none"> 5 V for at least 1000 ms 
5TTL		TTL Output Levels: <ul style="list-style-type: none"> passive 0 V  active 5 V  Pulse: <ul style="list-style-type: none"> 5 V for at least 1000 ms 
6OC		TTL-compatible output Levels: <ul style="list-style-type: none"> passive 5 V  active 0 V  Pulse: <ul style="list-style-type: none"> 5 V for at least 1000 ms 
GND		Reference point of the voltage at the signal inputs.

Assignment	Connection	Function
1		<p>Relay contact</p> <p>The contact is on a floating basis. Its setting depends on the settings in software.</p> <p>Steady-rate signal:</p> <ul style="list-style-type: none"> passive = relay contact opened  active = relay contact closed  <p>Pulse:</p> <ul style="list-style-type: none"> Closed relay contact for at least 1000 ms <p>Permissible performance of this relay contact: 1 A / 24 V DC </p>
2		<p>Relay Contact</p> <p>The contact is on a floating basis. Its setting depends on the settings in software.</p> <p>Steady-rate signal:</p> <ul style="list-style-type: none"> passive = relay contact opened  active = relay contact closed  <p>Pulse:</p> <ul style="list-style-type: none"> Closed relay contact for at least 1000 ms <p>Permissible performance of the relay contact: 1 A / 24 V DC </p>

4.10.3 Connecting the pin header

To control one device through another, you use the pin header. To use remote control, you have to connect cables to the pin header. The single ports are used to exchange control signals.

- Prerequisites**
- The device is switched off.
 - The power plug is disconnected from the device.
- Tools**
- Operating tool

NOTICE

Electronic defect

Connecting cables to the multi-pin connector of a switched on device causes a short circuit.

- Turn off the device before connecting cables.
- Pull the power plug.

NOTICE

Electronic defect

Electrostatic discharge can destroy the electronics.

- Wear a protective bracelet against electrostatic discharge and ground.

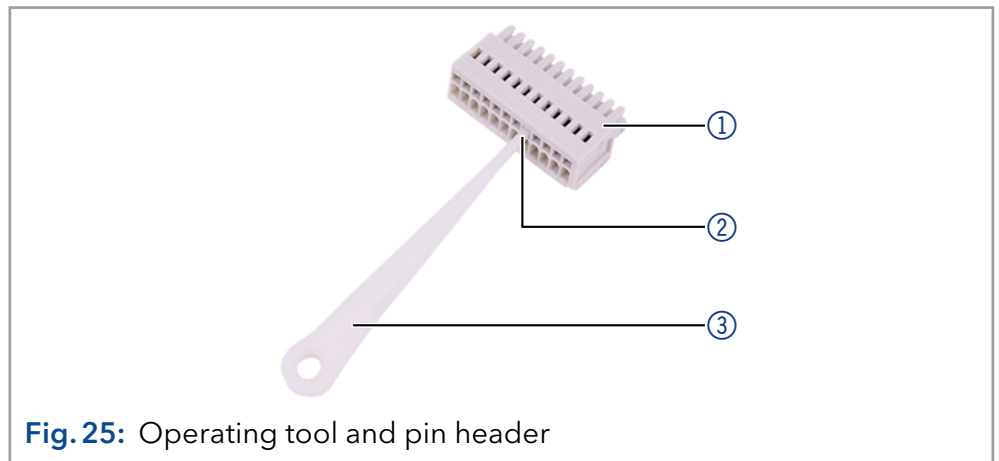

Fig. 25: Operating tool and pin header

Process

Procedure

1. Insert the operating tool ③ in an upper small opening at the front of the pin header ①.
2. Insert the cable into the opening ② below the inserted operating tool.
3. Pull out the operating tool.

Next steps

Check if the cables are firmly attached. Press the pin header onto the connector. Finish the installation. Put the device into operation.

5. Operation

5.1 Initial start-up

Use this checklist to determine whether the pump is ready for initial start-up:

- The device has been installed at a suitable operating site (see chapter 4.2 on page 14).
- The power plug has been connected.

If the device is part of an HPLC system, you should also note the following:

- The network connection to the router is established (see chapter 4.8.4 on page 30).
- The chromatography software has been installed by KNAUER or by a company authorized by KNAUER.
- The capillaries have been connected.

5.2 Control

There are several options for controlling the pump:

- with chromatography software
- with Mobile Control



Note: It is not possible to use two control methods simultaneously.

If the pump is connected to the software, the pump cannot be controlled via Mobile Control.

Chromatography software

To operate the device with the software, you have to establish a connection between the LAN port and a computer. You find a detailed description on chromatography software in a corresponding instruction.

Mobile Control

Mobile Control is a software which can be installed on your computer or tablet. To control the pump using Mobile Control, the computer or tablet should be connected to a wireless LAN router and should have Windows 10 as operating system.

A detailed description of the Mobile Control software you can find in the corresponding manual.

You can download the Mobile Control software and the manual on the KNAUER website <https://www.knauer.net/mobile-control-downloads> in the section "downloads".

5.3 Meaning of the LEDs

There are three LEDs ① and a standby switch ② on the front of the device. The figure shows the LED panel when the device is switched off.

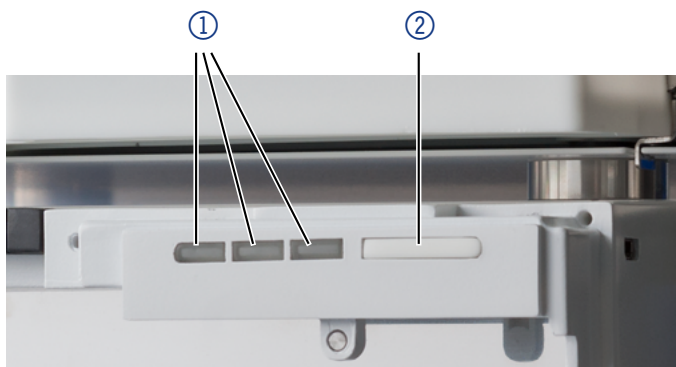

The LEDs can have different colors depending on the operating conditions.

	Color	Operating condition	Operation
Left LED	flashes red	Error message	<ul style="list-style-type: none"> Check the system. Read chapter "7.2 Possible problems and rectifications" on page 47. Shortly press the button to deactivate the error message.
	red	Serious error	<ul style="list-style-type: none"> Restart the device. If the operating status does not change, call the technical support.
	green	Program or sequence is running / has been loaded.	
Center LED	does not light	Pump does not transport solvent	Start flow via software
	flashes green	Device is equilibrating	Wait until the device is ready.
	green	Pump does transport solvent	
Right LED (Operational status)	green	Switched on	
	blue	standby	Exit with the standby button.
Standby	To start the standby, keep the button pressed for 5 seconds.		

5.4 Switching on the pump

Before the pump can be used, it must be purged to remove excess air in the capillaries. After switching on, the piston backflushing flushes automatically for 15 seconds.

Prerequisites ■ The installation has been completed.

NOTICE

Device defect

Changes of the ambient temperature cause condensation inside the device.

→ Allow device to acclimate for 3 h before connecting to power supply and taking into operation.

NOTICE

Component defect

Possible damage to the pump head due to dry running.

→ Make sure that solvent flows through the pump head and piston backflushing.

5.5 Pump head running-in



Note: All pump heads were filled with isopropanol before shipment.



Note: During the flushing process, a high pressure builds up inside the device. To prevent leaks, make sure that all tubings and capillaries are connected and all plugs have been removed from the purge valve.

Before taking in operation, after maintenance of the pump head, or if new pump heads have been installed, a running-in procedure must be carried out.

Make sure that the correct solvent is used, as in the specification table in the supplement "[Running-In procedure for pumping heads](#)" (Document No. V6894).

If a pump was not in operation for a long period of time, e.g. after shipping, a running-in procedure may be necessary in order to achieve the best pump performance. The pump head has performed this procedure during the manufacturing process.

If the pump is within the specification or during intensive operation, it is not necessary to carry out this running-in procedure.

Procedure

Process

1. Connect the pump with the power cable to the power supply.
2. Turn the power switch on.
3. Wait until the pump has completed the self-test.
4. Start the pump with a medium flow rate.

Next steps Afterwards, take the pump into operation.

5.6 Activate standby

Prerequisites The flow is turned off.



Note: Malfunctioning system after repeated standby possible. After repeatedly using the standby, switch off the power switch and back on again, to reset the data storage.

Procedure

1. Press the standby switch ② for 5 seconds.
2. Wait if the LED ① shows a blue light.

Figure

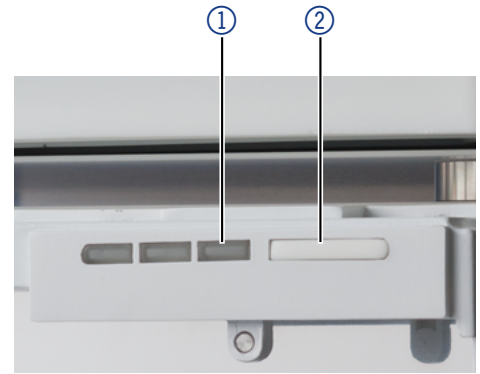

Result If you were successful, the right LED lights up blue.

Next steps To end standby, press the switch again.

6. Functionality tests



Note: Standard processes regarding IQ and OQ in single devices may be handled differently in individual cases.

6.1 Installation Qualification (IQ)

The customer may request the Installation Qualification, which is free of charge. In case of a request, the technical support of KNAUER or a provider authorized by KNAUER performs this functionality test during the installation.

The Installation Qualification is a standardized document that includes the following:

- confirmation of flawless condition at delivery
- check if the delivery is complete
- certification on the functionality of the device

You can either use the IQ document attached to this instruction manual or download a digital version from our website:



6.2 Operation Qualification (OQ)

The Operation Qualification includes an extensive functionality test according to KNAUER standard OQ documents. The Operation Qualification is a standardized document and free of charge. It is not part of the delivery. Please contact the technical support in case of a request.

The Operation Qualification includes the following:

- definition of customer requirements and acceptance terms
- documentation on device specifications
- device functionality check at installation site

Test intervals To make sure that the device operates within the specified range, you should test the device regularly. The test intervals depend on the usage of the device.

Execution The test can be carried out either by the technical support of KNAUER or by a provider authorized by KNAUER (for a fee). For further information visit our website:



7. Troubleshooting

First measures for troubleshooting:

- Check all cables and fittings.
- Check whether air has gotten into the supply lines.
- Check the device for leaks.

Further measures:

- Compare the current problem with the list of possible problems (see following sections)
- Contact the Technical Support.

7.1 LAN

Go through the following steps, in case no connection between the computer and the devices can be established. Check after each step if the problem is solved. If the problem cannot be located, contact the Technical Support.

1. Check the status of the LAN connection in the Windows task bar:



If no connection was established, test the following:

- Is the router switched on?
 - Is the patch cable connected correctly to the router and the computer?
2. Check the router settings:
 - Is the router set to DHCP server?
 - Is the IP address range sufficient for all the connected devices?
 3. Check all connections:
 - Are the patch cable connected to the LAN ports and not the WAN port?
 - Are all cable connections between devices and router correct?
 - Are the cables plugged in tightly?
 4. If the router is integrated into a company network, pull out the patch cable from the WAN port.
 - Can the devices communicate with the computer, even though the router is disconnected from the company network?
 5. Turn off all devices, router, and computer. First switch on the router and wait until it has successfully completed its self-test. Turn on the devices and then the computer.
 6. Replace the patch cable of the device to which no connection can be established.
 7. Make sure that the IP port of the device matches the port in the chromatography software.

7.2 Possible problems and rectifications

Problem	Solution
Device cannot be switched on	<ul style="list-style-type: none"> ■ Inspect the power cable to ensure that it is plugged into the power supply.
Left LED flashes red when pump is switched on	<ul style="list-style-type: none"> ■ An overpressure error has been detected on the flush valve and the pump cannot initialize. Remove the blind fittings/hoses from the purge valve and/or mixer and restart the pump.
When purging, the pump switches off.	<ul style="list-style-type: none"> ■ Make sure that you flush the pump via the purge command of the chromatography software, and that the flushing valve switches on this occasion. ■ Make sure that the waste tubes do not build up any backpressure (e.g. by clogging).
Pump does not transport solvent	<ul style="list-style-type: none"> ■ Flush the pump head to remove air bubbles. ■ Clean the check valves. ■ Replace the check valves. ■ If the pump head seals are defective, solvent enters the piston backflushing; inform the Technical Support. ■ Replace the pump head.
Pressure and flow rate variations	<ul style="list-style-type: none"> ■ Flush the pump head to remove air bubbles. ■ Always tighten the inlet fitting and the outlet fitting on the pump head with a torque wrench. ■ Clean the check valves. ■ Replace the check valves. ■ Replace the pump head.. ■ Contact the Technical Support.
Pump head leaks	<ul style="list-style-type: none"> ■ Inspect the inlet and outlet screw fittings of the pump head. ■ If the pump head seals are defective, Eluent enters the piston backflushing; inform the Technical Support of the manufacturer. ■ Replace the pump head.
Flow rate is not correct	<p>Check the following options:</p> <ul style="list-style-type: none"> ■ Clean the check valves. ■ Replace the check valves.
System failure	<p>Switch off the pump to reset the device's data storage. Switch the pump on again.</p>

7.3 System messages

If system messages other than those listed below are displayed, restart the machine. Inform the technical support if the error message appears repeatedly.

Error message	Measure
ERROR:404 Instrument in error state	Switch device off and on then on. Inform the technical support in case the system message repeats.
ERROR:416 Leak detected.	Switch off the device. Remove the leak and restart the device.
ERROR:424 Error input activated.	Eliminate the short circuit connected to 'Error In'.
ERROR:426 Leak sensor initialization failed.	Switch the device off and then on. If the leak sensor cannot be found, contact the technical support.
ERROR:473 RFID tag was not found.	Switch device off and on. Inform the technical support in case the system message repeats.
ERROR:10000 Unknown pump head type.	Switch device off and on. Inform the technical support in case the system message repeats.
ERROR:10001 No pump head detected.	Switch the device off. Ensure that the pump head is mounted correctly and switch the device on. Inform the technical support in case the system message repeats.
ERROR:10004 Pump head data read failed.	Switch the device off and on. Repeat the automatic configuration step in the chromatography software. Remove the pump head, clean it and install it again. Inform the technical support in case the system message repeats.
ERROR:10005 Pump head data write failed.	Switch the device off and on. Repeat the automatic configuration step in the chromatography software. Remove pump head, clean it and install it again. Inform the technical support in case the system message repeats.
ERROR:10008 Max pressure. System stopped.	Check whether the connected capillary and connectors are clogged. Adjust the maximum pressure limit. Restart the system.
ERROR:10009 Min pressure. System stopped.	Increase the pressure or adjust the lower pressure limit. Restart the system.
ERROR:10012 Components do not sum up to 100 percents.	Ensure that the sum of all gradient components equals 100 percent.

Error message	Measure
ERROR:10020 Drive controller _ overheat (_ degrees C).	Switch the device off and allow to cool down.
ERROR:10023 Purge valve switch failed.	An error occurred during switching of the purge valve. Restart the system.
ERROR:10027 High pressure during initialization/service.	System pressure exceeds safety limit during drive(s) initialization.

8. Maintenance and care

Proper maintenance of your HPLC device will ensure successful analyses and reproducible results.

NOTICE

Electronic defect

Performing maintenance tasks on a switched on device can cause damage to the device.

- Switch off the device.
- Pull the power plug.

Users may perform the following maintenance tasks themselves:

- Replacing the pump head
- Replacing the ball valves of the pumps

In case there are any maintenance tasks on that you do not find instructions here, contact your supplier or the Technical support.

8.1 Maintenance contract

The device may only be opened by the Technical Service of KNAUER or any company authorized by KNAUER. This maintenance work is covered by a separate maintenance contract.

8.2 Maintenance intervals

Display operating hours

With the help of Mobile Control and various software packages (e.g. ClarityChrom® or OpenLAB®), it is possible to display or read the operating hours of the pump. You find a detailed description on how to display or read out GLP data in the respective user manuals.

Operating hours	Measures
1 000	<ul style="list-style-type: none"> ■ Check the torque of the screw fittings ■ Clean the piston of the pump ■ Check the check valves in the pump head
5 000	<ul style="list-style-type: none"> ■ Replace seals ■ Clean the check valves in the pump head
10 000	<ul style="list-style-type: none"> ■ Replacing the pump head spare parts ■ Replace the check valves in the pump head

8.3 Cleaning and caring for the device

8.3.1 Cleaning surfaces

NOTICE

Device defect

Intruding liquids can cause damage to the device.

- Place solvent bottles next to the device or in a solvent tray.
- Moisten the cleaning cloth only slightly.

All smooth surfaces of the device can be cleaned with a mild, commercially available cleaning solution, or with isopropanol.

Touchscreens can be cleaned with isopropanol and wiped dry with a soft, lint-free cloth.

8.3.2 Flushing the pump

The pump with all components (valves, degasser) should be flushed after each operation and before initial start-up. Flush the pump also to clean the tubings before changing the eluent and to eliminate air bubbles in the tubes. If buffer solutions have been used, make sure that the buffer solution is compatible with the selected flushing solution.

Flushing solution

- If buffers have been used, flush with water.
- If aggressive solvents were used, flush with isopropanol.

Prerequisites

- The capillaries and tubings have been connected.
- The pump has been switched on.

Procedure

Process

1. Immerse the solvent tubing in the flushing solution.
2. In the chromatography software, start the purge via the function "Purge". The purge valve automatically switches, connecting the pump head outlets with the waste tubings which are installed on the purge valve.
3. Finish the purge over the function "Purge" in the chromatography software.

Result

After purging the pump, no more air bubbles or contaminating material are in the pump head and in the capillaries.

Next steps

Take the pump into operation.

8.4 Check the torque of the screw fittings

Use the following torques for the respective components:

- Inlet and outlet fittings of the pump heads: 7.5 Nm
- Stainless steel capillary fittings: 5 Nm

8.5 Dismounting the pump head

Prerequisites The pump head has been flushed with flushing solution.

- Tools**
- Open-end wrench, size 1/4"
 - Screwdriver Torx 25

⚠ WARNING

Chemical burns

Skin damage from aggressive or toxic eluents.

- Wear protective gloves.
- Flush the pump head before changing.

NOTICE

Component defect

Possible damage to the pump piston by tilting the pump head.

- Tighten diagonally opposite fastening screws evenly one turn at a time.
- Also loosen the fastening screws evenly.

Procedure

Process

1. Loosen the finger tight fittings on the piston backflushing ① and the outlet ②. Remove all tubings.
2. Loosen the screw ③ with a wrench (size 1/4"). Remove the capillary.

Figure

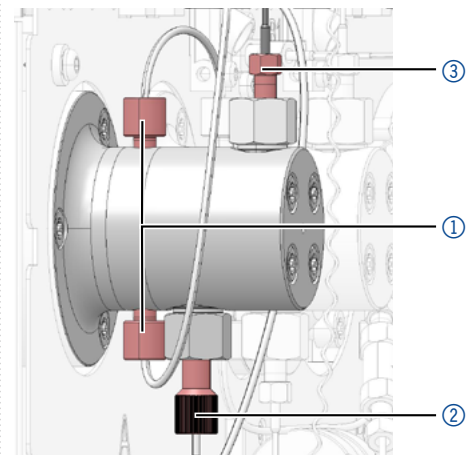

Fig. 26 Outlet screw fitting

3. Loosen the three mounting screws ④ with the Torx screwdriver (size 25) one after the other around one turn at a time.
4. Hold the pump head with one hand and remove the screws.
5. Remove the pump head.

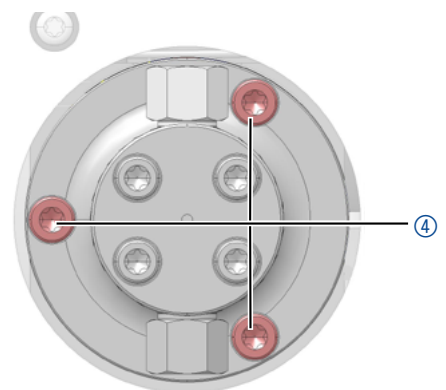

Fig. 27 Screws

Next Steps Wait for the check valves or install a new pump head.

8.6 Check valves

Dirty check valves do not open and close properly. They cause pressure fluctuations and irregular flow. If it is impossible to clean the check valves, replace the whole unit.

- Procedure**
- Removing the check valves
 - Cleaning the check valves
 - Installing the check valves

8.6.1 Removing check valves

A check valve is located in the pump head piston above the lower fitting.

- Prerequisites**
- The pump head piston has been flushed.
 - The capillaries and tubings have been removed.

Tools Open-end wrench, size 13

Procedure

Process

Figure

1. Loosen the screw ① from the pump head piston with a wrench.

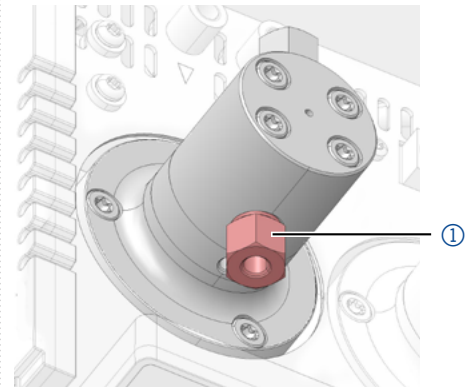

Fig. 28 Lower fitting

2. Remove the check valve ②.

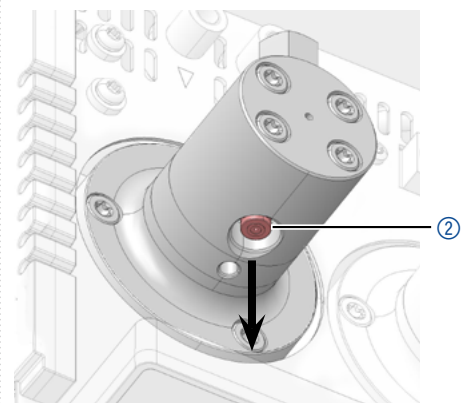

Fig. 29 Check valve

Next steps Cleaning the check valve

8.6.2 Cleaning check valves

The check valves are not disassembled for cleaning but they are cleaned as a unit.

Prerequisites ■ The check valve is removed from the pump head piston.

Procedure

Process

1. Place the check valve in a beaker with solvent, e.g. isopropanol.
2. Put the beaker in an ultrasonic bath for at least 10 minutes.
3. Let the ball valve dry afterwards.

Next step Reinstall the cleaned check valve.

8.6.3 Installing check valves

NOTICE

Component defect

Damage to components due to excessive tightening possible.
Observe the torque of the screw connection

→ Use 7.5 Nm torque for stainless steel fittings.

Place the check valve into the pump head piston in the flow direction. The notch of the check valve points **down**.

Normal phase Place the check valve into the pump head piston in the flow direction. The arrow of the check valve points **up**.

Prerequisites ■ The check valves are dry.

Procedure

Process

1. Insert the check valve ① so that the notch ② points downwards (normal phase: arrow points upwards)..

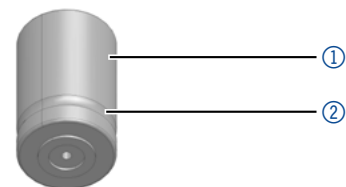

Fig. 30 Check valve

2. Screw the fittings into the pump head piston and tighten them with a torque wrench and the proper torque value.

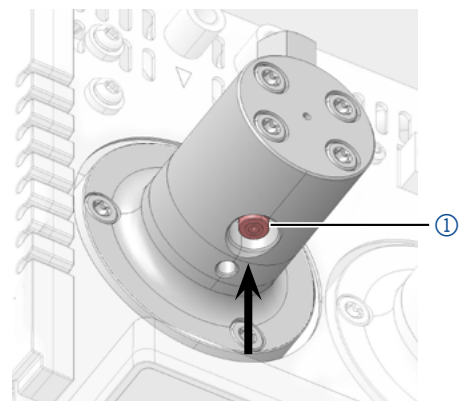

Fig. 31 Check valve in pump head piston

Result The pump head piston is ready for use.

8.6.4 Removing dummy check valves

A dummy check valve is located in the pump head piston below the upper fitting.

- Prerequisites**
- The pump head piston has been flushed.
 - The capillaries and tubings have been removed.
- Tools**
- Open-end wrench, size 13

Procedure

Process

Figure

1. Loosen the screw ① from the pump head piston with a wrench.

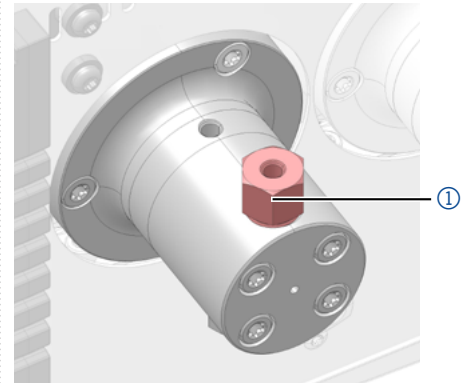

Fig. 32 Upper fitting

2. Remove the dummy check valve ②.

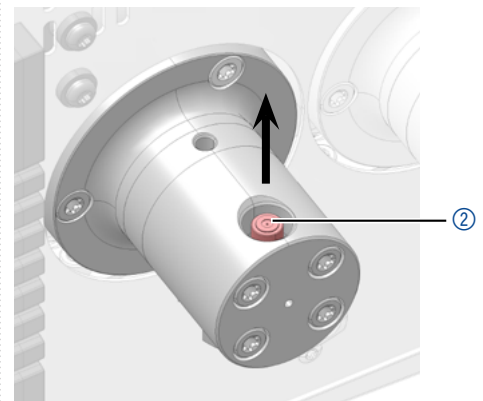

Fig. 33 Dummy check valve

Next step Install new dummy check valve.

8.6.5 Installing dummy check valves

NOTICE

Component defect

Damage to components due to excessive tightening possible.
Observe the torque of the screw connection

→ Use 7.5 Nm torque for stainless steel fittings.

Place the dummy check valve into the pump head piston.

- Prerequisites**
- The old dummy check valve has been removed.

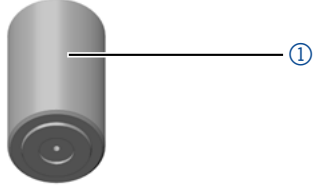
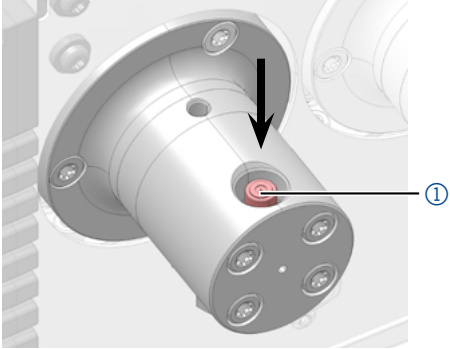
Procedure	Process	Figure
	<ol style="list-style-type: none"><li data-bbox="507 219 970 286">1. Place the dummy check valve ① into the pump head piston.<li data-bbox="507 297 970 432">2. Screw the fittings into the pump head piston and tighten them with a torque wrench and the proper torque value.	 <p data-bbox="1002 443 1353 477">Fig. 34 Dummy check valve</p> <hr/>  <p data-bbox="1002 880 1465 947">Fig. 35 Dummy check valve in pump head piston</p>

Result The pump head piston is ready for use.

8.7 Replacing the mixing chamber

A clogged mixing chamber can cause pressure fluctuations and irregular flow. The mixer is replaced completely as a single assembly.

- Prerequisites**
- The mixer has been flushed with isopropanol.
 - The hole plugs are laid out ready.

- Tools**
- Open-end wrench, size ¼"
 - Torx wrench, size 10

Process

1. Unscrew the capillaries ① with the wrench or by hand.
2. Close the inlet and the outlet with the plugs.
3. Remove the screws ② with the Torx wrench.
4. Remove the mixer and lay it to the side.
5. Install the new mixing chamber.
6. Screw the connections of the capillary on the mixing chamber by hand.
7. Tighten the screws with a torque wrench with the proper torque value.

Figure

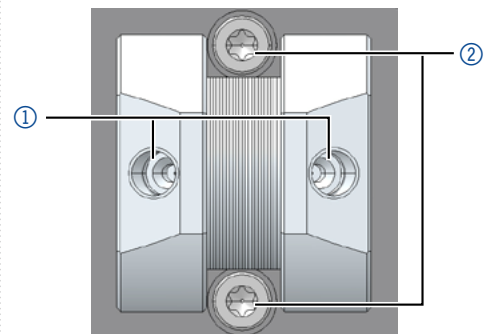

Fig. 36 HPLC mixing chamber

Next step Take the device into operation.

8.8 Replacing the inline filter cartridge

8.8.1 Location of inline filter cartridge holder

Legend

- ① Inline filter cartridge holder

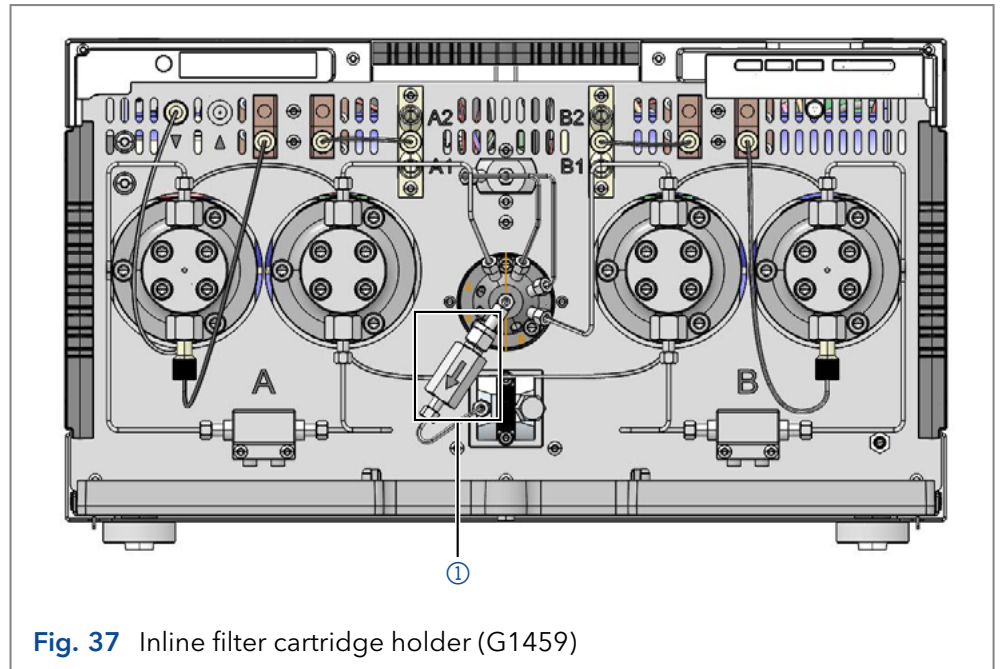

Fig. 37 Inline filter cartridge holder (G1459)

8.8.2 Exchanging the inline filter

A clogged filter cartridge inside the pressure sensor can cause pressure variations and irregular flow.

- i** | **Note** The flow direction is marked on inline filter cartridges.

NOTICE

Component defect

Damage to components due to excessive tightening possible.
Observe the torque of the screw connection.

- Use 5 Nm torque for stainless steel fittings.
- Use 1 Nm torque for PEEK fittings.

- Prerequisites**
- The pump has been flushed (with water or isopropanol).
- Tools**
- Torque wrench, size ¼"
 - Torque wrench, size 10 mm
 - Open-end wrench, size 13 mm
 - Open-end wrench, size 10 mm
- Spare parts**
- Inline filter cartridge (article no. G1451A)
 - Inline filter cartridge holder incl. filter cartridge (article no. G1459)



Procedure	Process	Figure
	<ol style="list-style-type: none"> <li data-bbox="507 215 863 315">1. Loosen capillaries ① and ② on the cartridge holder. 	 <p>The diagram shows a top-down view of the cartridge holder assembly. Two capillaries are highlighted with circled numbers 1 and 2. Capillary 1 is connected to the top of the holder, and capillary 2 is connected to the side. The holder is mounted on a pump unit.</p>
	<ol style="list-style-type: none"> <li data-bbox="507 651 863 719">2. Remove the cartridge holder ③ from the unit. 	 <p>The diagram shows the cartridge holder assembly being lifted away from the pump unit. The holder is labeled with a circled number 3. The pump unit has ports labeled A1 and B1.</p>
	<ol style="list-style-type: none"> <li data-bbox="507 1267 863 1335">3. Unscrew the inline filter cartridge. <li data-bbox="507 1346 863 1413">4. Replace the inline filter cartridge ④. 	 <p>The diagram shows the inline filter cartridge being unscrewed. The cartridge is labeled with a circled number 4. It consists of a top cap, a middle ring, and a bottom cap.</p>
<div data-bbox="389 1671 453 1738" style="display: inline-block; border: 1px solid black; padding: 2px; margin-right: 5px;">i</div> <p data-bbox="491 1682 895 1850">Note: Pay attention to alignment. The three rings on the inline filter mark the inlet side. The red arrow marks the flow direction.</p>		 <p>The diagram shows the inline filter cartridge with a red arrow pointing downwards, indicating the flow direction. The cartridge is labeled with a circled number 4.</p>

Fig. 38 Capillaries on cartridge holder

Fig. 39 Removing cartridge holder

Fig. 40 Cartridge holder unscrewed

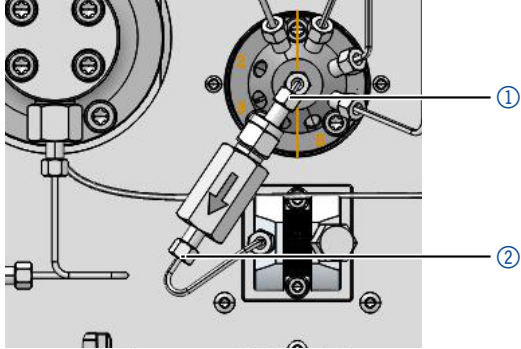
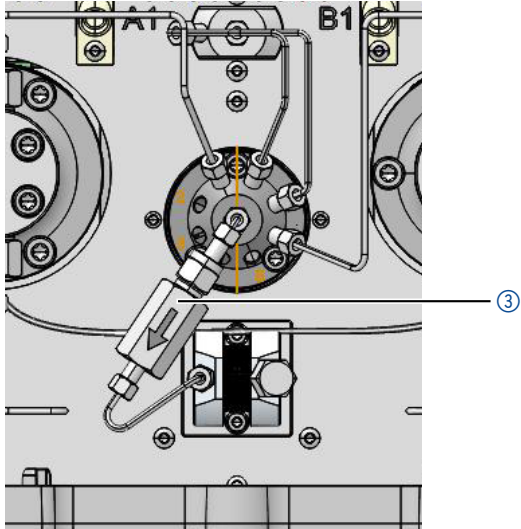
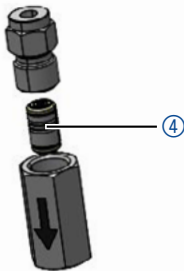
Fig. 41: Inline filter cartridge (G1451A)

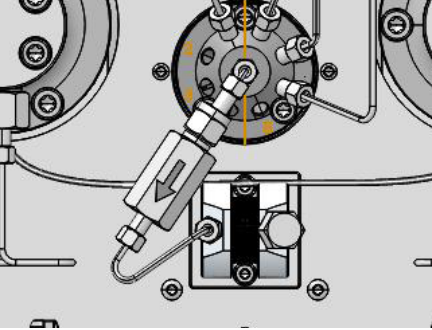
Procedure	Process	Figure
	5. Screw the cartridge holder together and tighten with 8 Nm.	 <p data-bbox="922 465 1390 539">Fig. 42: Cartridge holder screwed together</p>
	6. Screw the cartridge holder with capillaries to the purge valve and mixer.	 <p data-bbox="922 929 1453 1003">Fig. 43: Capillaries connected to inline filter holder and purge valve</p>
	7. Tighten all capillary connections with 5 Nm.	

Result The inline filter cartridge has been replaced.

8.9 Removing a leakage

- Prerequisites**
- The device is switched off.
 - The device is disconnected from the mains.

- Auxiliary material**
- Cloth

Procedure	Process
	1. Remove the leak.
	2. Dry the leakage tray with the cloth.
	3. Confirm the error message via the chromatography software.

Next steps Afterwards, take the device into operation.

8.10 Taking the pump out of service

NOTICE

Device defect

Residuals chemicals can damage the pump head if they are not being removed before storage.

- For reuse, flush the pump head and fill it with isopropanol.
- Before storage, seal the inlets and outlets with cap fittings.

The pump is designed for the use of a variety of solvents. If the pump has not been used for several weeks, solvent residues can damage the device. Therefore, it is recommended that all components of the pump to flush, to remove the used solvent completely, and to fill all components and tubings of the pump with isopropanol.

All open connections should be closed. Capillaries and tubings which connect individual components of the pump must not be removed.

- Prerequisites**
- The pump has been flushed.
 - The pump has been switched off.

Procedure

Process

1. Pull the power plug out of the socket and then out of the device.
2. Pack the power supply cable together with the device.
3. Remove the pump head pistons (see chapter 8.5 on page 52).
4. Disconnect remaining electrical connections and dismount all accessories.

- Next steps** Carefully prepare the device for transport or storage (see chapter 9 on page 62).

9. Transport and storage

Regarding the following information, carefully prepare the device for transport or storage.

9.1 Packing the device

CAUTION

Bruising danger

The device could fall down and cause injury when carried, placed or installed.

→ To carry or move the device, grasp the device only at the center of the side.

→ Do not carry the device alone, but always with two people.

- Original packaging: Ideally you should use the original transport packaging.
- Lifting: Grab the device around the center of both sides and lift it into the packaging. Do not hold onto front cover or leak tray, as these parts are loosely attached to the device.

9.2 Transporting the device

- Documents: If you want to return your device to KNAUER for repairs, enclose the „[Service request form and decontamination report](#)“ which can be downloaded from our website.
- Device data: For a secure transport, note the weight and dimensions of the device (see chapter 11 on page 64).

9.3 Storing the device

- Flushing solution: Pay attention that all hoses and capillaries have been emptied or filled with flushing solution (e. g. isopropanol) before storage. To prevent algae formation, do not use pure water.
- Seals: Close all inputs and outputs with cap fittings.
- Ambient conditions: The device can be stored under ambient conditions which are listed in the chapter Technical Data (see chapter 11 on page 64).

10. Disposal

Hand in old devices or disassembled old components at a certified waste facility, where they will be disposed of properly.

10.1 AVV-Marking Germany

According to the German "Abfallverzeichnisverordnung" (AVV) (January, 2001), old devices manufactured by KNAUER are marked as waste electrical and electronic equipment: 160214.

10.2 WEEE registration number

KNAUER as a company is registered by the WEEE number DE 34642789 in the German "Elektroaltgeräteregister" (EAR). The number classifies to category 8 and 9, which, among others, comprises laboratory equipment.

All distributors and importers are responsible for the disposal of old devices, as defined by the WEEE directive. End-users can send their old devices manufactured by KNAUER back to the distributor, the importer, or the company free of charge, but would be charged for the disposal.

10.3 Eluents and other operating materials

All eluents and other operating materials must be collected separately and disposed of properly.

All wetter components of a device, e. g. flow cells of detectors or pump heads and pressure sensors for pumps, have to be flushed with isopropanol first and water afterwards before being maintained, disassembled or disposed.

11. Technical data

11.1 Main features

Solvent conveyance	Pump type	Analytical UHPLC pump
	Delivery system	Double serial piston pump
	Pulsation compensation	Active pulsation compensation
	Piston seal washing	Active wash
	Flow rate accuracy	$\pm 0.25\%$ (water, 1 ml/min, 1200 bar)
	Flow rate precision	$\leq 0.04\%$ RSD or 0.008 min SD whichever is greater
	System protection	Soft start, P_{\min} and P_{\max} are programmable
	Gradient range	0 - 100 % in 0.1 % increments
	Solvent selection valve	HPG only
	Gradient formation	HPG
	Liquid temperature range	4 - 60 °C (39.2 - 104 °F)
	HPG: gradient accuracy	$\pm 0.3\%$
	HPG: gradient precision	$< 0.1\%$ RSD at 1 ml/min, based on retention time at constant room temperature
Degasser module	Degasser channels	4 channels
	Max. flow rate/channel	5 ml/min
	Degassing method	Gas permeation through amorphous fluoropolymer membrane
	Degassing efficiency	< 0.5 ppm dissolved O_2 at 1 ml/min
	Degassing chamber volume	280 μ l volume per channel
	Solvent applicability	Universal, with exception of hydrochloric acid and halogenated hydrocarbons
	Wetted materials	PEEK, Tefzel® (ETFC), Systec AF™

11.2 Communication

Display	Mobile Control (optional)
Inputs	LAN, Pin header connectors (Analog IN, Start IN, Error IN)
Analog inputs	Flow rate, 0 - 10 V via pin header connectors
Analog control input	Flow rate
Level/event outputs	8 event outputs (TTL, OC, relay) and 24 V
Control	LAN, Analog and event control, Mobile Control

11.3 General

Technical parameters	Leak sensor	Yes
	Special features	Pump head is detected automatically using Radio frequency identification (RFID)
Ambient conditions	Ambient temperature	4 – 40 °C (39.2 – 104 °F)
	Air humidity	Below 90 %, non-condensing
	Operating altitude	Max. 2000 meters
	Area of use	For indoor use only
	Permitted pollution degree	2
	Protection type	IP20
	Power supply	100 – 240 V, 50 – 60 Hz, Maximum power consumption 310 W
	Line voltage fluctuations do not exceed	± 10 % of normal voltage.
	Overvoltage category II:	Energy consumers are supplied by a fixed device.
	Dimensions (W × H × D)	361 mm x 208.2 mm x 523 mm
	Weight	26.7 kg
Pump specifications	Pump head	5 ml
	Continuous working conditions	0.1 - 4 ml/min
	Best working conditions	0.02 - 5 ml/min
	Flow rate increment	0.001 ml/min
	Mixing volume	50 µl (HPG)
	Wetted materials	Stainless steel, sapphire, ruby, PEEK, zirconium oxide, nickel-cobalt-chromium-molybdenum alloy (MP35N®), diamond-like carbon (DLC), polyimide (Vespel®), polyethylene
	Maximum delivery pressure	18000 psi / 1240 bar / 124 MPa
	Flow rate range (adjustable)	0.001 – 5 ml/min
	Pump head material	Stainless steel
	Purge valve	Automated

12. Repeat orders

The list of repeat orders is up-to-date at the time of publication. Deviations are possible at later points in time.

Keep the attached list with the scope of supply for subsequent orders. If there are any questions concerning repeat orders, contact the Technical Support.

Further Information Further information on spare parts and accessories can be found online: www.knauer.net.

12.1 Device

Name	Order number
Pump P 8.1L HPG with 5 ml pump head (stainless steel)	APF45PA

12.2 Accessories and spare parts

	Name	Order number
Pump head	Pump head, 5 ml, stainless steel	AHA70
Check valve	Check valve unit for AZURA® 5/10 ml pump head, ruby sapphire	A06841
Capillaries	Start-Up Kit with flexible, precut capillaries for analytical HPLC and UHPLC systems with 1/16" connections	AZF50
	ULDC capillary kit to minimize extra column volume	A9990
Mixing chambers	AZURA® mixing chamber 50 µl	AZZ00MB
	AZURA® mixing chamber 100 µl	AZZ00MC
	AZURA® mixing chamber 200 µl	AZZ00MD
	AZURA® mixing chamber 400 µl	AZZ00MF
	AZURA® mixing chamber 600 µl	AZZ00MG
Solvent tray	AZURA® eluent tray E 2.1L	AZC00
Drainage system	Corrugated hose, 16 cm, PE grey	A9846-1
	Corrugated hose, 150 cm, PE grey	A9846-3
	Funnel	P6431
	Exhaust	P6432
Capillary guide	Capillary guide top	P6424
	Capillary guide side	P6425
Mobile Control	Mobile Control license with 10" touchscreen	A9607
	Mobile Control Chrom license with 10" touchscreen	A9608
	Mobile Control licence	A9610
	Mobile Control Chrom license	A9612

	Name	Order number
Accessories kit	AZURA® accessories kit	FZA02
	Accessories kit P 8.1L	FPF45
Tools	AZURA® tool kit	A1033
	Cleaning kit for capillaries	A0137
	Cutter for metal tubing	A0681
Product riser	AZURA® product riser (28 mm)	A9860
Power cable	USA	M1651
	UK	M1278
	Switzerland	M1597
	Europe	M1642
Documents	Instructions AZURA® Pump P 8.1L	V6770
	Installation Qualification document	VIQ-INST
	Operation Qualification document	VOQ-Pumps

13. Chemical compatibility of wetted materials



Note: The user takes the responsibility for using the fluids and chemicals in an appropriate and safe way. If there is any doubt, contact the Technical Support of the manufacturer.

13.1 General

The device is very resistant against a variety of commonly used eluents. However, make sure that no eluents or water come in contact with the device or enter into the device. Some organic solvents (such as chlorinated hydrocarbons, ether) may cause coating damage or loosen glued components by improper handling. Even small quantities of other substances, such as additives, modifiers, or salts can influence the durability of the materials. Exposure time and concentration have a high impact on the resistance.

The following list contains information about the chemical compatibility of all wetted materials which are used in devices made by KNAUER. The data bases on a literature research on the manufacturer specifications of the materials. The wetted materials of this device are listed in the chapter "Technical data".

All resistances mentioned here are for use at temperatures up to 40 °C, unless stated otherwise. Please note that higher temperatures can significantly affect the stability of different materials.

13.2 Plastics

Polyetheretherketone (PEEK)

PEEK is a durable and resistant plastic and, next to stainless steel, the standard material in HPLC. It can be used at temperatures up to 100 °C and is highly chemical resistant against almost all commonly used solvents in a pH range of 1-12.5. PEEK is potentially moderate resistant against oxidizing and reducing solvents.

Therefore, following solvents should not be used: Concentrated and oxidizing acids (such as nitric acid solution, sulfuric acid), halogenated acids (such as hydrofluoric acid, hydrobromic acid) and gaseous halogens. Hydrochloric acid is approved for most applications.

In addition, following solvents can have a swelling effect and may have an impact on the functionality of the built-in components: Methylene chloride, THF and DMSO in any concentration such as acetonitrile in higher concentrations.

Polyethylene terephthalate (PET, outdated PETP)

PET is a thermoplastic and semi-crystalline material with high wear resistance. It is resistant against diluted acids, aliphatic and aromatic hydrocarbons, oils, fats and alcohols, but not against halogenated hydrocarbons and ketones. Since PET belongs chemically to esters, it is not compatible with inorganic acids, hot water and alkalis. Maximum operating Temperature: up to 120 °C.

Polyimide (Vespel®)

This material is wear-resistant and permanent resilient thermally (up to 200 °C) as well as mechanically. It is chemically broadly inert (pH range 1-10) and is especially resistant against acidic to neutral and organic solvents, but vulnerable to pH strong chemical or oxidizing environments: It is incompatible with concentrated mineral acids (such as sulfuric acid), glacial acetic acid, DMSO and THF. In addition, it will be disintegrated by nucleophilic substances like ammonia (such as ammonium salts under alkaline conditions) or acetate.

Ethylene-tetrafluorethylene copolymer (ETFC, Tefzel®)

This fluorinated polymer is highly resistant against neutral and alkaline solvents. Some chlorinated chemicals in connection with this material should be handled with care. Maximum operating Temperature is 80 °C.

Perfluorethylenpropylen-Copolymer (FEP), Perfluoralkoxy-Polymer (PFA)

These fluorinated polymers hold similar features as PTFE, but with a lower operation temperature (up to 205 °C). PFA is suitable for ultra-pure applications, FEP can be used universally. They are resistant against almost all organic and inorganic chemicals, except elemental fluorine under pressure or at high temperatures and fluorine-halogen compounds.

Polyoxymethylene (POM, POM-HTF)

POM is a semi-crystalline, high-molecular thermoplastic material which stands out due to its high stiffness, low friction value and thermic stability. It can even substitute metal in many cases. POM-H-TF is a combination of PTFE fibres and acetal resin and is softer and has better slip properties as POM. The material is resistant against diluted acids (pH > 4) as well as diluted lyes, aliphatic, aromatic and halogenated hydrocarbons, oils and alcohols. It is not compatible with concentrated acids, hydrofluoric acid and oxidizing agent. Maximum operating Temperature is 100 °C.

Polyphenylene sulfide (PPS)

PPS is a soft polymer which is known for its high break resistance and very high chemical compatibility. It can be used with most organic, pH neutral to pH high, and aqueous solvents at room temperature without concerns. However, it is not recommended for using with chlorinated, oxidizing and reducing solvents, inorganic acids or at higher temperatures. Maximum operating temperature: 50 °C.

Polytetrafluorethylene (PTFE, Teflon®)

PTFE is very soft and anti-adhesive. This material is resistant against almost all acids, lyes and solvents, except against fluid sodium and fluoride compounds. In addition, it is temperature-resistant from -200 °C to +260 °C.

Systec AF™

This amorphous perfluorinated copolymer is inert against all commonly used solvents. However, it is soluble in perfluorinated solvents like Fluorinert® FC-75 and FC-40, and Fomblin perfluor-polyether solvents from Ausimont. In addition, it is affected by Freon® solvents.

Polychlorotrifluoroethylene (PCTFE, Kel-F®)

The semi-crystalline thermoplastic material is plasticizer-free and dimensionally stable, even in a wide temperature range (–240 °C to +205 °C). It is moderately resistant against ether, halogenated solvents and toluene. Halogenated solvents over +60 °C and chlorine gas should not be used.

Fluorinated rubber (FKM)

The elastomer consisting of fluorinated hydrocarbon stands out due to a high resistance against mineral oils, synthetic hydraulic fluids, fuels, aromatics, and many organic solvents and chemicals. However, it is not compatible with strong alkaline solvents (pH value >13) like ammonia, and acidic solvents (pH value <1), pyrrole and THF. Operating temperature: Between –40 °C and +200 °C.

Perfluorinated rubber (FFKM)

This perfluoro elastomer has a higher fluorine content as fluorinated rubber and is therefore chemically more resistant. It can be employed at higher temperatures (up to 275 °C). It is not compatible with Pyrrole.

13.3 Non-metals

Diamond-like carbon (DLC)

This material is characterized by a high hardness, a low coefficient of friction and thus low wear. In addition, it is highly biocompatible. DLC is inert against all acids, alkalis and solvents commonly used in HPLC.

Ceramic

Ceramic is resistant against corrosion and wear and is fully biocompatible. An incompatibility against acids, alkalis and solvents commonly used in HPLC is not known.

Alumina (Al₂O₃)

Due to their high resistance to wear and corrosion, alumina ceramic is used as a coating for mechanically stressed surfaces. It is a biocompatible material with low thermal conductivity and low thermal expansion.

Zirconium oxide (ZrO₂)

Zirconia ceramics are characterized by their high mechanical resistance, which makes them particularly resistant to wear and corrosion. It is also biocompatible, has low thermal conductivity and is resistant to high pressures.

Sapphire

Synthetic sapphire is virtually pure monocrystalline alumina. It is biocompatible and very resistant to corrosion and wear. The material is characterized by a high hardness and a high thermal conductivity.

Ruby

Synthetic ruby is monocrystalline alumina and gets its red color by the addition of some chromium oxide. It is biocompatible and very resistant to corrosion and wear. The material is characterized by a high hardness and a high thermal conductivity.

Mineral wool

This insulating material consists of glass or stone wool fibres and isolates in high oxidizing conditions and at high temperatures. Mineral wool is valid as commonly inert against organic solvents and acids.

Glass, glass fibre, quartz, quartz glass

These mineral materials are resistant against corrosion and wear and are mostly chemical inert. They are compatible with oils, fats and solvents and show a high resistance against acids and lyes up to pH values of 3-9. Concentrated acids (especially hydrofluoric acid) may embrittle and corrode the minerals. Lyes may ablate the surfaces slowly.

13.4 Metals

Stainless steel

Stainless steel is, apart from PEEK, the standard material in HPLC. Steels with WNr. 1.4404 (316L) are used, or with a mixture of higher compatibility.

They are inert against almost all solvents. Exceptions are biological applications which are metal ion sensible, and applications with extreme corrosive conditions. These steels, in comparison to commonly used steels, are increasingly resistant against hydrochloric acid, cyanides and other halogen acids, chlorides and chlorinated solvents.

The use in ion chromatography is not recommended. In case of electrochemical applications, a passivation must be executed first.

Hastelloy®-C



This nickel-chrome-molybdenum alloy is extremely resistant to corrosion, especially against oxidizing, reducing and mixed solvents, even at high temperatures. This alloy may be used in combination with chlorine, formic acid, acetic acid and saline solutions.

Titanium, titanium alloy (TiAl6V4)

Titanium has a low weight and a high hardness and stability. It stands out due to its very high chemical compatibility and biocompatibility. Titan is applied when neither stainless steel nor PEEK are usable.

Appendix: Installation Qualification (IQ)

Installation Qualification (IQ) for a Device

	Created	Reviewed	Approved
Function	Technical editor	Engineering	Head of Quality
Name	Anna Erben	Paul Pietsch	Kate Monks
Date	23/08/2022	29/08/2022	30/08/2022
Signature	 <small>Digital unterschrieben von Anna Erben Datum: 2022.08.23 14:09:27 +02'00'</small>		

0. Customer approval

Prior to installation at the customer site, the customer has reviewed the OQ document and agrees with the design and scope

Company name:

Name	Function	Reviewed & approved	Date	Signature

Installation Qualification (IQ) for a Device

1. Definition of the Installation Qualification

The qualification document „Installation Qualification (IQ)“ is part of the quality management system at the company KNAUER Wissenschaftliche Geräte GmbH.

2. Scope

The customer can request the Installation Qualification. In case of a request, the technical support of KNAUER or a provider authorized by KNAUER performs this functionality test during the installation. The IQ is a standardized document and includes the following:

- Confirmation of flawless condition at delivery
- Check if the delivery is complete
- Certification on the functionality of the device

3. Instructions

All deviations from the specifications that occurred during installation have to be recorded in this document.

In addition, all measures taken to eliminate the deviations have to be noted down as comments in the list of rectifications (LOR) on page 4.

If certain items in the report are not applicable, this has to be indicated in the table as „N/A“ (not applicable). Major sections that are not used have to be crossed out (diagonal line), marked „N/A“, dated and signed.

All required documents have to be completed by the end of the installation. The document has to be reviewed and approved by an authorized person. The review and approval have to be documented with signature and date (DD/MM/YYYY).

The tests have to be carried out in a suitable environment, as described in the user instruction of the device.

4. About this document

The information in this document is subject to change without prior notice. This document may not be used, reproduced or translated without written consent of KNAUER Wissenschaftliche Geräte GmbH. Depending on the customer's quality assurance system, the signed document either has to be filed in the device folder or scanned and stored in an electronic archive.

5. Device data

Device name		Product number	
Serial number		Order number	
Firmware version			
Installation location			

6. Customer and manufacturer data

	Customer	Manufacturer
Company		KNAUER Wissenschaftliche Geräte GmbH
Customer number		-
Contact person/agent		
Address		Hegauer Weg 38
Postal Code/City		14163 Berlin
Phone		+49 30 80 97 27 111
E-Mail		support@knauer.net

Installation Qualification (IQ) for a Device

7. Installation Qualification Tests

Test	Description	Specification	Passed	Failed	N/A	Comment/LOR No.
1	Identify the device.	The name on the device matches the name on the delivery order.				
2	Check the device for transport damage.	No transport damage is observed.				
3	Check the scope of delivery.	The scope of delivery matches the packing list and/or the delivery order.				
4	Check that the technical documentation provided is correct and complete (material documentation of wetted parts, calibration certificates etc.)	The documentation is correct and complete.				
5	Check that all equipment is properly and correctly labeled according to the delivery order and/or the labeling specifications document, if applicable.	The equipment is labeled correctly.				
6	Connect all loose parts (e.g. capillaries, tubings, measuring head) according to the user instructions.	The device is fully assembled and ready to use.				
7	Ensure that the installation site is suitable according to the user instructions.	The installation site matches the specifications in the user instructions.				
8	Connect the device to the power supply and switch it on.	The device starts (operating noise). The power LED or the display lights up.				

Installation Qualification (IQ) for a Device

8. List of rectifications (LOR)

LOR No.	Test No.	Type of deviation*	Description of the deviation	Action plan	Persons responsible	Due date	Date/signature

*Type of deviation:

A = acceptable (e.g. not a GMP-critical deviation)

N = not acceptable

Continuation of qualification activities into the next qualification phase is only possible when deviation is rectified.

T = temporarily acceptable

a) Release and use of the system is possible, even when the deviation is not rectified.

b) A continuation of qualification activities into the next qualification phase is possible, even when the deviation is not rectified

Installation Qualification (IQ) for a Device

9. List of changes to the document

Revision no.	Description of change	Additional information	Date/signature

Installation Qualification (IQ) for a Device

10. Certificate and approval

A KNAUER employee or an employee authorized by KNAUER has checked the device and performed all tests described in the IQ.

The IQ form has to be signed by an authorized person. The scope of the IQ meets the customer’s requirements.

The results of the IQ, any changes made as well as the IQ process have been documented in this form in writing. The users listed below were instructed and are familiar with how to operate the device. Both parties confirm that the IQ has been performed to the customer’s satisfaction by signing it.

10.1 Customer approval

Name	Function	Date	Signature

10.2 KNAUER agent approval

Name	Function	Date	Signature

11. Comments / recommendations

Science with Passion



Latest KNAUER instructions online:
www.knauer.net/library

KNAUER
Wissenschaftliche Geräte GmbH
Hegauer Weg 38
14163 Berlin

Phone: +49 30 809727-0
Fax: +49 30 8015010
E-mail: info@knauer.net
Internet: www.knauer.net