

BlueShadow

Pump 40P Instructions



Document no. V7613

HPLC



Note: For your own safety, read the instructions and follow the warnings and safety information on the device and in the instructions. Keep the instructions for future reference.



Note: In case you require this instruction in another language, please submit your request including the corresponding document number via e-mail or fax to KNAUER.

Support: Do you have questions about the installation or the operation of your instrument or software?

International Support:

Contact your local KNAUER partner for support:

www.knauer.net/en/Support/Distributors-worldwide

Support in Germany

(Austria & Switzerland on case-to-case basis):

Phone: +49 30 809727-111 (workdays 9-17h CET)

Fax : +49 30 8015010

E-mail: support@knauer.net

Publisher: KNAUER Wissenschaftliche Geräte GmbH

Hegauer Weg 38

14163 Berlin

Germany

Phone: +49 30 809727-0

Fax: +49 30 8015010

Internet: www.knauer.net

E-mail: info@knauer.net

Version information: Document number: V7613

Version number: 1.2

Release date: April 29, 2022

Translation of the original edition

The information in this document is subject to change without prior notice. For the latest version of the instructions, visit our website: www.knauer.net/library.



Copyright: This document contains confidential information and may not be reproduced without written consent of KNAUER Wissenschaftliche Geräte GmbH.

© KNAUER Wissenschaftliche Geräte GmbH 2022
All rights reserved.

Table of contents

1. General	1
1.1 About these instructions	1
1.2 Signal words	1
1.3 Additional typographical conventions	1
1.4 Legal information	2
1.4.1 Liability limitation	2
1.4.2 Transport damage	2
1.4.3 Warranty conditions	2
1.4.4 Warranty seal	2
1.4.5 Declaration of conformity	2
2. Basic safety instructions	3
2.1 Intended use	3
2.1.1 Operating ranges	3
2.1.2 Foreseeable misuse	3
2.2 User qualification	3
2.3 Operator responsibility	4
2.4 Personal safety equipment	4
2.5 Working with solvents	4
2.5.1 General requirements	4
2.5.2 Contamination by health-threatening solvents	5
2.5.3 Avoiding leakage	5
2.6 Specific environments	5
2.6.1 Earthquake-endangered areas	5
2.6.2 Explosive environment	5
2.6.3 Cooling room	5
2.6.4 Wet room	6
2.7 Maintenance, care and repair	6
2.8 Service request form and decontamination report	6
3. Product information	7
3.1 Views	7
3.1.1 Front view	7
3.1.2 Rear view	7
3.2 Features	8
3.3 Pump heads	8
3.4 RFID recognition	8

3.5	Symbols and signs	9
3.6	Scope of delivery	9
4.	Installation and initial startup	10
4.1	Unpacking	10
4.2	Ambient conditions	10
4.2.1	Operation site	10
4.2.2	Ambient temperature	10
4.2.3	Space requirements	11
4.3	Power supply	11
4.3.1	Power supply requirements	11
4.3.2	Power supply cables and plugs	11
4.4	Electric connections	12
4.4.1	Connecting cables to the pin header	12
4.4.2	Remote connector	13
4.4.3	Events connector	14
4.5	Connecting capillaries and fittings	15
4.5.1	Connecting the solvent bottles	15
4.5.2	Connecting the pump head to the solvent	16
4.6	Control	17
4.6.1	Setting up LAN	17
4.6.2	Configuring LAN settings	18
4.6.3	Connecting devices with LAN	18
4.6.4	Configuring the router	19
4.6.5	Integrating LAN into the company network	20
4.6.6	Controlling several systems separately in LAN	20
4.7	Setting IP addresses via software	20
4.7.1	Firmware Wizard: Setting a static IP address	21
4.7.2	Firmware Wizard: Setting a dynamic IP address	22
5.	Operation	23
5.1	Initial operation	23
5.1.1	Pump head running-in	23
5.1.2	Isocratic operating mode	24
5.1.3	Optimizing HPLC separations	24
5.2	Purging the pump	24
5.2.1	Piston backflushing	25
5.3	Switch on and self test	26
5.4	Operating with LC display and keypad	26
5.4.1	LED status	27
5.4.2	RFID icon	27
5.4.3	Operating with the keypad	28

5.5	Menu structure	29
5.5.1	Main menu	29
	Navigate through main menu	29
5.5.2	Menu structure: overview	30
5.5.3	Device setting parameters	31
5.6	<i>GLP</i> menu	35
	Navigate through <i>GLP</i> menu	35
5.7	<i>Program</i> menu	35
	Navigate through <i>Program</i> menu	35
5.7.1	Create program	35
5.7.2	Run program	36
5.7.3	Change program	36
5.7.4	Delete program lines	36
5.7.5	Delete a program	37
5.7.6	Create a program with a starting time	37
5.8	<i>Link</i> menu	37
	Navigate <i>Link</i> menu	37
5.8.1	Create link	38
5.8.2	Run link	38
5.8.3	Delete link	38
6.	Functionality tests	39
6.1	Installation Qualification (IQ)	39
6.2	Operation Qualification (OQ)	39
7.	Troubleshooting	40
7.1	LAN	40
7.2	Possible problems and solutions	41
7.3	System messages	42
8.	Maintenance and care	45
8.1	Maintenance contract	45
8.2	Cleaning and caring for the device	45
8.3	Checking the fittings	45
8.4	Flushing the pump	46
8.5	Maintaining the pump head	46
	8.5.1 Dismounting the pump head	46
	8.5.2 Check valves	48
8.6	Maintaining the filter cartridge at pressure sensor	50
	8.6.1 Removing filter cartridge	50
	8.6.2 Inserting a new filter cartridge	52

9. Transport and storage	54
9.1 Putting the pump out of operation	54
9.2 Packing the device	54
9.3 Transporting the device	54
9.4 Storing	54
9.4.1 Storing the device	54
9.4.2 Storing the pump head	55
10. Disposal	56
10.1 AVV-Marking Germany	56
10.2 WEEE registration number	56
10.3 Eluents and other operating materials	56
11. Technical data	57
11.1 Solvent delivery	57
11.2 Communication	58
11.3 Technical parameters	58
11.4 General	58
12. Chemical compatibility of wetted materials	59
12.1 General	59
12.2 Plastics	59
Polyetheretherketone (PEEK)	59
Polyethylene terephthalate (PET, outdated PETP)	59
Polyimide (Vespel®)	60
Ethylene-tetrafluorethylene copolymer (ETFC, Tefzel®)	60
Perfluorethylenpropylen-Copolymer (FEP), Perfluoralkoxy-Polymer (PFA)	60
Polyoxymethylene (POM, POM-H-TF)	60
Polyphenylene sulfide (PPS)	60
Polytetrafluorethylene (PTFE, Teflon®)	60
Systec AF™	60
Polychlorotrifluorethylene (PCTFE, Kel-F®)	61
Fluorinated rubber (FKM)	61
Perfluorinated rubber (FFKM)	61
12.3 Non-metals	61
Diamond-like carbon (DLC)	61
Ceramic	61
Alumina (Al ₂ O ₃)	61
Zirconium oxide (ZrO ₂)	61
Sapphire	61

	Ruby.....	61
	Mineral wool.....	62
	Glass, glass fibre, quartz, quartz glass.....	62
12.4	Metals.....	62
	Stainless steel	62
	Hastelloy®-C.....	62
	Titanium, titanium alloy (TiA16V4).....	62
13.	Repeat orders.....	63
13.1	Devices	63
13.2	Spare parts	63

1. General

1.1 About these instructions

These operating instructions enable the safe and efficient operation of the device. The user must have carefully read and understood these operating instructions before starting any work.





The basic prerequisite for safe operation is compliance with all safety instructions (see chapter 2 on page 3). In addition to the safety and warning instructions in these operating instructions, the local accident prevention regulations and the national industrial safety regulations apply.

These operating instructions are an integral part of the device. It must be kept in the immediate vicinity of the device and accessible to the user at all times.

You can download these and other instructions from the KNAUER website: www.knauer.net/library

1.2 Signal words

Possible dangers related to the device are distinguished in personal and material damages.

Symbol	Meaning
	DANGER (red) indicates a highly hazardous situation. If not avoided, it will result in death or serious injury.
	WARNING (orange) indicates a hazardous situation. If not avoided, it could result in death or serious injury.
	CAUTION (yellow) indicates a moderate hazardous situation. If not avoided, it could result in minor or moderate injury.
	NOTICE (blue) is used to address issues which are not related to physical injury.

1.3 Additional typographical conventions

Note: Specific information are prefixed with the word „Note“ and an information icon.

 **Note:** This is an example.

1.4 Legal information

1.4.1 Liability limitation

The manufacturer is not liable for the following issues:

- Non-compliance of these instructions
- Non-observance of necessary safety precautions
- Improper use
- Operation of the device by unqualified personnel (see chapter 2.2 on page 3)
- Use of non-approved spare parts
- Technical changes by the user such as opening the device and unauthorized modifications
- Violations of General Terms and Conditions (GTC)

1.4.2 Transport damage

The packaging of our devices provides the best possible protection against transport damage. However, check the packaging for transport damage. In case you notice any damage, inform the Technical Support and the shipping company within three workdays.

1.4.3 Warranty conditions

For information on warranty please refer to our general terms and conditions on the website: www.knauer.net/terms

1.4.4 Warranty seal

A blue or orange warranty seal is affixed to some devices.

- A blue seal is used by KNAUER's Manufacturing or Customer Support for devices to be sold.
- After repair, service technicians attach an orange seal onto the identical position.

After repair, the service technician affixes an orange seal in the same place. If unauthorised persons tamper with the device or if the seal is damaged, the warranty will lapse.



1.4.5 Declaration of conformity

The declaration of conformity is enclosed as a separate document with the product and can be obtained online:

www.knauer.net/en/Support/Declarations-of-conformity

2. Basic safety instructions

The device has been developed and constructed in such a way that hazards arising from its intended use are largely excluded. Nevertheless, the following safety instructions must be observed in order to exclude residual hazards.

2.1 Intended use

Only use the device for applications that fall within the range of the intended use. Otherwise, the protective and safety equipment of the device could fail.

2.1.1 Operating ranges

The device is intended to be used indoors for chromatographic applications.



Note: The device can also be used for dosing applications if the *Dosing mode* is selected and the maintenance cycles are followed. A warning message appears on the device display when the maximum operating time is reached.

2.1.2 Foreseeable misuse

Refrain from the use of the device for the following purposes or conditions:

- Medical purposes. The device is not approved as a medical product.
- Operating outdoors. Otherwise, the manufacturer does not guarantee the functionality and safety of the device.
- Operation in potentially explosive areas without special and additional explosion protection. Contact the KNAUER Customer Support for more information.

2.2 User qualification

The users are qualified to handle the device if all of the following points apply:

- They have at least a basic knowledge of liquid chromatography.
- They have knowledge about the properties of the used solvents and their health risks.
- They are trained for the special tasks and activities in the laboratory and know the relevant standards and regulations.
- Due to their technical training and experience, they can understand and carry out all the work described in the operating instructions on the instrument and recognize and avoid possible dangers independently.
- Their ability to react is not impaired by the consumption of drugs, alcohol or medication.
- They have participated in the installation of an instrument or training by KNAUER or an authorized company.

If users do not meet these qualifications, they must inform their supervisors.

2.3 Operator responsibility

The operator is any person who operates the device himself or leaves it to a third party for use and who bears the legal product responsibility for the protection of the user or third parties during operation.

The obligations of the operator are listed below:

- Know and follow the applicable work safety regulations.
- Identify hazards arising from the working conditions at the place of use in a risk assessment.
- Set up operating instructions for the operation of the device.
- Regularly check whether the operating instructions correspond to the current status of the regulations.
- Clearly regulate and specify responsibilities for installation, operation, troubleshooting, maintenance and cleaning and set clear rules.
- Ensure that all personnel who work with the device have read and understood these operating instructions.
- Train the personnel who work with the device at regular intervals and inform them about the dangers.
- Provide the necessary safety equipment to the employees working with the unit (see section below).

2.4 Personal safety equipment

The protective measures required in the laboratory must be observed and the following protective clothing worn during all work on the device:

- Safety glasses with side protection
- Protective gloves in accordance with the prevailing ambient conditions and used solvents (e.g. heat, cold, protection against chemicals)
- Lab coat
- Personalised protective safety equipment which is specified in the particular laboratory

2.5 Working with solvents

2.5.1 General requirements

- The user is trained for handling different solvents.
- Note recommended solvents and concentrations in these instructions in order to avoid personal injury or damage to the device. For example, certain chemicals may cause PEEK capillaries to swell or burst (see chapter 12 on page 59).
- Note that organic solvents are toxic above a certain concentration. For handling hazardous solvents see the following section.
- Mobile phases and samples may contain volatile or combustible solvents. Avoid the accumulation of these substances. Ensure good ventilation of the installation site. Avoid open flames and sparks. Do not operate the instrument in the presence of flammable gases or vapors.

- Only use solvents which do not self-ignite under given conditions. This applies especially to the use of a thermostat where liquids could get onto hot surfaces in the interior.
- Degas solvents before use and observe their purity.

2.5.2 Contamination by health-threatening solvents

- Contamination with toxic, infectious or radioactive substances poses a hazard for all persons involved during operation, repair, sale, and disposal of a device.
- All contaminated devices must be properly decontaminated by a specialist company or the operating company before they can be recommissioned, repaired, sold, or disposed (see chapter 10 on page 56).

2.5.3 Avoiding leakage

Risk of electrical shock or short circuit if solvents or other liquids leak into the interior of the device. You can avoid a leakage through the following measures:

- Tightness: Visually check the device or system regularly for leaks.
- Solvent tray: The use of a solvent tray prevents liquids get from the bottles into the inside of the device.
- Eluent lines: Install capillaries and hoses in such a way that, in case of a leak, liquids cannot get into the interior of the devices underneath.
- In case of leakage: Switch off the system. Only take the device into operation if the cause of the leak has been resolved (see chapter 8 on page 45).

2.6 Specific environments

2.6.1 Earthquake-endangered areas

In earthquake-endangered areas, do not stack more than 3 devices on top of each other. Otherwise there is risk of injury due to falling devices or loose parts.

2.6.2 Explosive environment

Never use the system in potentially explosive atmospheres without appropriate protective equipment. For more information, contact the KNAUER Customer Support.

2.6.3 Cooling room

You may operate the device in a cooling room. To prevent condensation, note the following instructions:

- Allow the device to acclimatize for min. 3 hours before taking it into operation.
- After taking into operation, the device should stay switched on.
- Avoid temperature fluctuations.

2.6.4 Wet room

The device must not be operated in wet rooms.

2.7 Maintenance, care and repair

- Avoiding electric shock: Before performing any maintenance and service work, disconnect the device from the power supply.
- Tools: Use only tools recommended or prescribed by the manufacturer.
- Spare parts and accessories: Only use original parts and accessories made by KNAUER or a company authorized by KNAUER.
- PEEK fittings: Use PEEK fittings only for a single port or brand-new PEEK fittings in order to avoid dead volume or not exactly fitting connections.
- Column care: Follow KNAUER or other manufacturer's instructions on caring for the columns (see www.knauer.net/columncare)
- Used capillaries: Do not use any used capillaries elsewhere in the system in order to avoid dead volumes, not exactly fitting connections and spreading contamination.
- Safety features: The device may only be opened by the KNAUER Customer Support or any company authorized by KNAUER (see chapter 1.4.1 on page 2).
- For more information visit the KNAUER website: www.knauer.net/hplc-troubleshooting

2.8 Service request form and decontamination report

Devices which are shipped without the completed document "Service request form and decontamination report" will not be repaired. If you would like to return a device to KNAUER, make sure to enclose the completed document: www.knauer.net/servicerequest

3. Product information

3.1 Views

3.1.1 Front view

Legend

- ① Display
- ② Pressure sensor
- ③ Ventilation screw
- ④ Keypad
- ⑤ Tube connections for the piston backflushing
- ⑥ Pump head

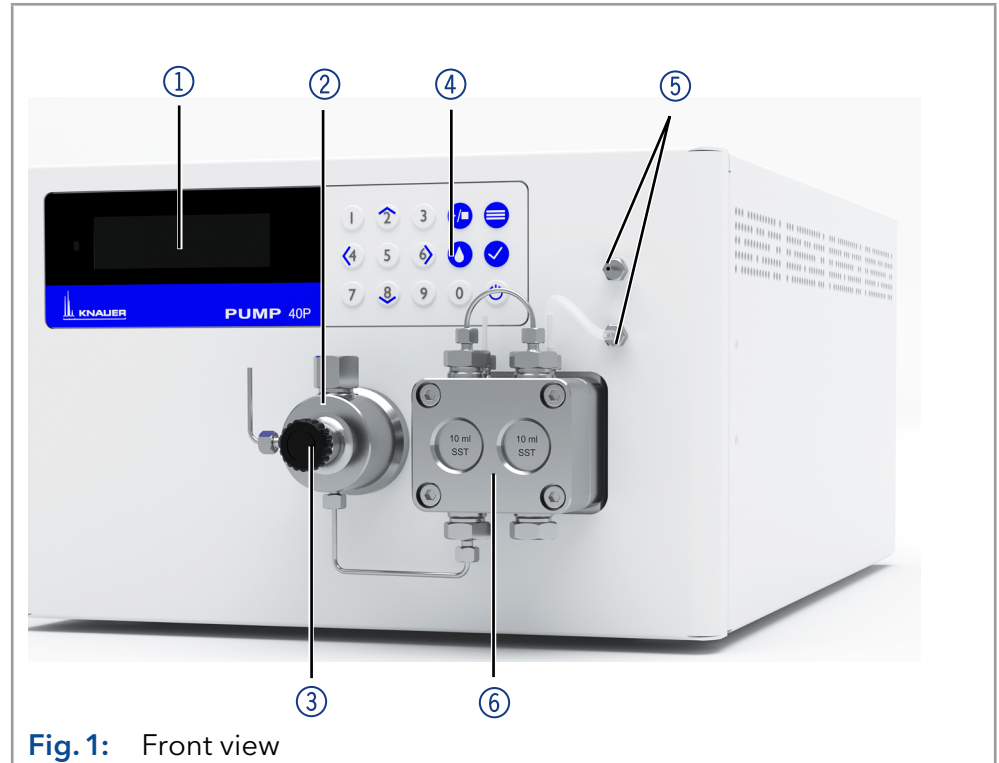

Fig. 1: Front view

3.1.2 Rear view

Legend

- ① Warranty seal
- ② Space for rear label (with serial number)
- ③ Fan opening
- ④ Warning 1
- ⑤ Power switch
- ⑥ Power supply
- ⑦ CE-Mark
- ⑧ Remote connector
- ⑨ RS-232 Port
- ⑩ Warning 2
- ⑪ LAN connection
- ⑫ Events connector

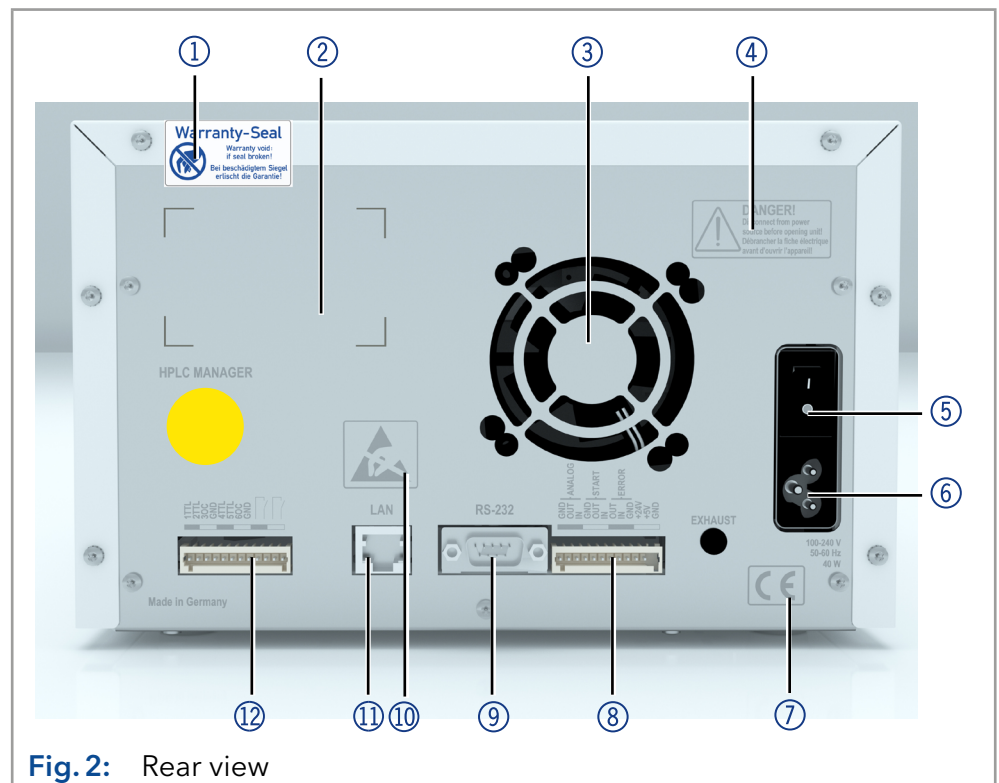

Fig. 2: Rear view

3.2 Features

- Dual-piston technology combined with optimized electronic pulsationdampening and compressibility compensation
- Liquid transport with low pulsation, stable flow rate and high flow accuracy
- Pump head made of stainless steel or with ceramic inlays
- Automatic piston backflushing
- High physical and chemical stability
- Direct pump control via analog and digital signals
- Control with chromatography software

3.3 Pump heads



Note: Due to the new drive used in the pump, pump heads of older series cannot be used any more.

Available pump head types:

- Pump head 10 ml, for use in analytical applications, standard version made of stainless steel. Ceramic inlays for biocompatible applications. Stainless steel pump head for high-temperature applications.
- Pump head 50 ml, for use in semi-preparative applications, standard version made of stainless steel. Ceramic inlays for biocompatible applications. Stainless steel pump head for high-temperature applications.

Labeling on pump heads

The front of the pump head is labeled with the max. pumping capacity (10 ml or 50 ml). Pump heads with inlays carry additional material labels (SST for stainless steel, C for ceramic).

Automatic pump head recognition

The pump automatically recognizes the pump head by means of an RFID chip.

3.4 RFID recognition





The pump head is equipped with an RFID chip. It is used to monitor and save all important parameters and settings of the pump and pump head.

The RFID technology offers the following advantages:

- Automatic detection of all important pump head parameters by means of radio signals (radio frequency identification), by the pump software or the chromatography software:
 - Pump head type
 - Serial number and year of manufacture
 - Number of cycles and operating times
 - Limit values of the pump head parameters
- All measuring data archived in accordance with GLP (good laboratory practice)
- Transfer of all data to the software and pump display

3.5 Symbols and signs

The following symbols and signs can be found on the device:

Symbol	Meaning
	High-voltage hazard
	Electrostatic discharge hazard, damages to system, device, or components can occur.
	A device marked with CE fulfills the product specific requirements of European directives. This is confirmed in a Declaration of Conformity.
	A warranty seal is affixed to some devices. For more information see chap. 1.4.4 on p. 2.

3.6 Scope of delivery



Note: Only use original parts and accessories made by KNAUER or a company authorized by KNAUER.

- Power cable
- BlueShadow Pump 40P with pump head
- Accessories kit pump 40P
- Accessories kit pump head

Applicable documents:

- User manual
- Installation Qualification
- Declaration of Conformity

4. Installation and initial startup

Before you determine the operation site, read the chapter “Technical data” (see chapter 11 on page 57). There you will find all device-specific information on power supply, ambient conditions and humidity.



Note: The intended use be ensured only if the requirements for ambient conditions of the operating environment are met.

4.1 Unpacking

Process

Procedure

1. Place the packaging in such a way that the lettering on the label is in the correct position.
2. Check the packaging, the device and the accessories for transport damage.
3. Check the scope of delivery. In the event of incomplete delivery, contact Technical Support immediately.
4. When lifting, carrying or moving the device, grab the unit only from below on the sides. Do not hold onto front cover or leak tray, as these parts are loosely attached to the device.

Next steps

- Keep the included packing list for repeat orders.
- Keep the original packaging for safe storage or transportation.

4.2 Ambient conditions

4.2.1 Operation site

Observe the following requirements for the operation site so that the measurement results are not influenced:

- Place on a firm, level and straight surface.
- Protect against direct sunlight.
- Do not expose to air drafts such as air conditioning systems.
- Do not set up the to other machines that cause floor vibrations.
- Keep from high frequency sources.
- Ensure adequate ventilation (see chapter 4.2.3 on page 11).
- Avoid temperature fluctuations (see chapter 4.2.2 on page 10).

4.2.2 Ambient temperature

If the ambient temperature of the device is abruptly changed (e.g. when it is installed in a cooling chamber), condensation will form inside the device and may cause damage to the device. Allow the device to acclimate for 3 h, before it is connected to the power supply and taken into operation.

4.2.3 Space requirements

- Make sure that the power plug on the power supply (wall socket or power strip) is always accessible, so that the device can be disconnected from the power supply.
- Ensure adequate ventilation around the device, otherwise it may overheat and malfunction:
 - Min. 5 cm distance if another device is set on one side.
 - Min. 10 cm distance if further devices are set on both sides.
 - At least 15 cm to the cooler fan on the rear.

4.3 Power supply

4.3.1 Power supply requirements

- Failure-free power supply: For failure-free operation, the electrical voltage must be free of fluctuations, residual currents, voltage peaks and electromagnetic interference. The device must receive sufficient voltage and reserve capacity.
- Check voltage: Only connect devices to a power supply whose voltage corresponds to the permissible voltage of the device.
- Power consumption: The nominal power of the connected devices must not exceed 50 % of the highest connected power capacity, since higher currents can flow briefly when the device is switched on.
- Main connection: The electrical power supply at the operation site must be connected directly to the nearest main power connection.
- Grounding: The connectors for the voltage must be grounded accordingly.

4.3.2 Power supply cables and plugs

- Original parts: For power supply, use the supplied power cable and plug to meet the specifications which are described in the chapter "Technical data" (see chapter 11 on page 57). Detachable power cables are not allowed to be replaced with other cable types.
- Country-specific plugs: Before switching on the device, check whether the supplied plug is approved for your country. Overview of the device- and country-specific plug types from KNAUER: www.knauer.net/plugs.
- Power strips: If several devices are connected to one power strip, always consider the maximum power consumption of each device.
- Access to power supply: Make sure that the power plug on the power supply (wall socket or power strip) is always accessible, so that the device can be disconnected easily from the power supply.
- Damaged power supply cables and plugs: For safety reasons, damaged or faulty cables and plugs must not be used to connect the device to the power supply. Replace defective cables and plugs only with KNAUER accessories.

4.4 Electric connections

- Use the Events and Remote pin header to connect the pump with external devices.
- Use the LAN connection to connect the pump with external devices within a network.
- Alternatively, connect the pump to a computer with the RS-232 port.

NOTICE

Electronic defect

Electrostatic discharge can destroy the electronics.

→ Wear a protective bracelet against electrostatic discharge and ground.

4.4.1 Connecting cables to the pin header

To control one device through another, the pin header is used. To use remote control, you have to connect cables to the pin header. The single ports are used to exchange control signals.

- The device is switched off.
- The power plug is pulled.

Tool Depressor tool

NOTICE

Electronic defect

Connecting cables to the multi-pin connector of a switched on device causes a short circuit.

→ Turn off the device before connecting cables.

→ Pull the power plug.

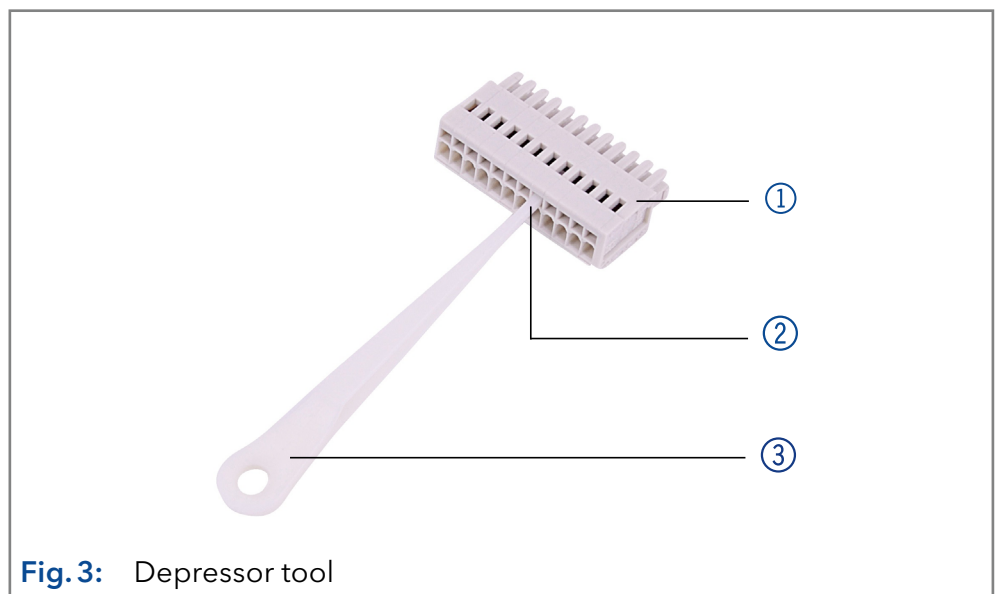

Fig. 3: Depressor tool

Process

1. Push the depressor tool ③ into an upper small opening on the front of the terminal strip ①.
2. Lead the cable into the opening ② below the inserted operating tool.
3. Remove the depressor tool.

- Next steps**
- Check if the cables are firmly connected.
 - Push the terminal strip onto the pin header.
 - Finish the installation.
 - Put the device into operation.

4.4.2 Remote connector

- For receiving start, control and error signals from external devices
- For sending start, control and error signals to external devices



Fig. 4: Remote connector

Signal	Explanations
ANALOG: OUT	<ul style="list-style-type: none"> ■ Analog output signal reflecting either the measured system pressure or a control voltage for pump B. ■ The output range can be set to values of max. 1, 2, 5 and 10 V.
ANALOG: IN	Analog input signal for controlling the flow rate, e.g.: <ul style="list-style-type: none"> ■ 1 V for 1 ml/min in the case of the 10 ml pump head ■ 1 V for 5 ml/min in the case of the 50 ml pump head.
START: OUT	Output is active for 500 ms when the pump starts.
START: IN	Device starts after signal (short circuit to GND) of an external device. During software control an electronic trigger is sent via LAN.
ERROR: OUT	Output is active until the Error condition has been eliminated.
ERROR: IN	A voltage of 0 V against GND stops the pump.

4.4.3 Events connector

- Sending control signals (Events) to external devices
- Opening and closing contacts
- Activating 500 ms pulses

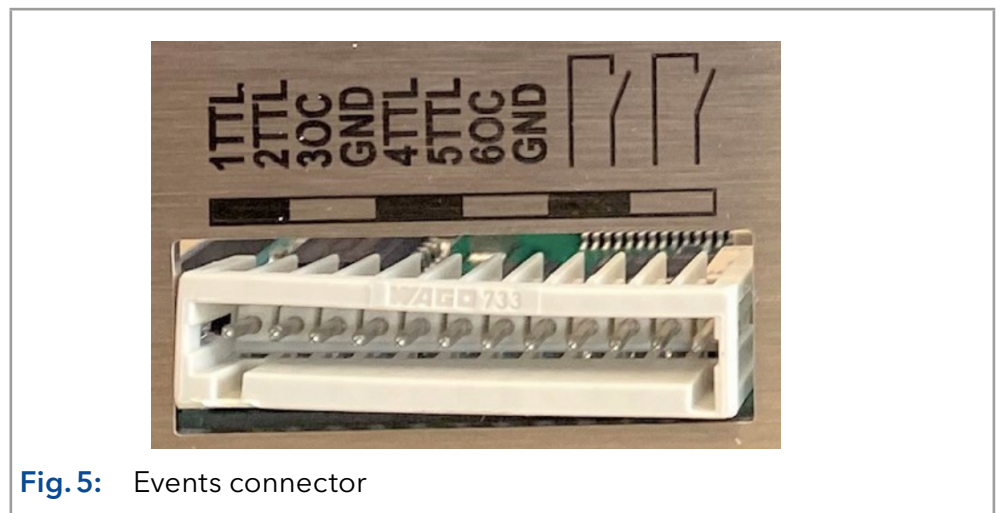

Fig. 5: Events connector

4.5 Connecting capillaries and fittings

The capillary connecting the pump head and flushing valve is already pre-installed. Only the solvent bottles have to be connected and the pump has to be integrated into the flow of the HPLC system.

4.5.1 Connecting the solvent bottles

To connect the solvent bottles, tubing with pre-installed solvent filters is used. The tubing is connected to the device with flangeless fittings.

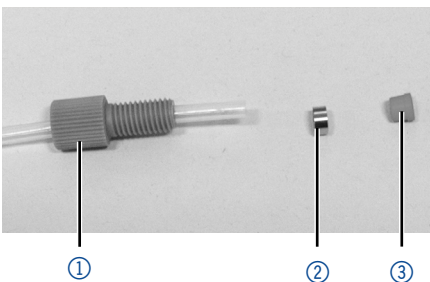
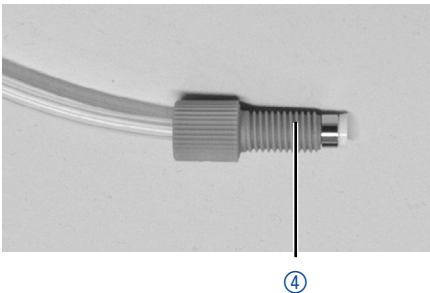

Note: Do not use any tools to tighten the fittings.

Procedure	Process	Figure
	<ol style="list-style-type: none"> 1. Slide the flangeless fitting ① over the tubing. 2. Slide the lock ring ② over the tubing. 3. Cap with the sealing ring ③. Note the direction of the lock ring, otherwise the sealing ring could be damaged. The thicker end of the lock ring must point into the direction of the fitting. 	 <p>Fig. 6: Setup of a flangeless fitting</p>
	<ol style="list-style-type: none"> 4. Manually fasten the flangeless fitting ④ to the device. 	 <p>Fig. 7: Fully assembled flangeless fitting</p>

4.5.2 Connecting the pump head to the solvent

- Check that all fittings are tight.
- Isocratic system: Connect the solvent reservoir either via an external degasser or directly to the pump.



Note: The manufacturer generally recommends the use of a degassing module to reliably deliver the solvent as eluent.

- Prerequisites**
- The device has been switched off.
 - The power plug has been pulled.
 - The front cover has been removed.

- Material**
- Flangeless fitting

NOTICE

Device defect

Damage to pump head, device or system when inlet and outlet of the pump head are blocked.

→ Remove the cap fittings from the inlet and outlet of the pump head prior to use.

Procedure

Process

1. Slide the flangeless fitting over the tubing.
2. Insert the tubing into the free inlet ① on the bottom of the pump head.
3. Tighten the fitting by hand.

Figure

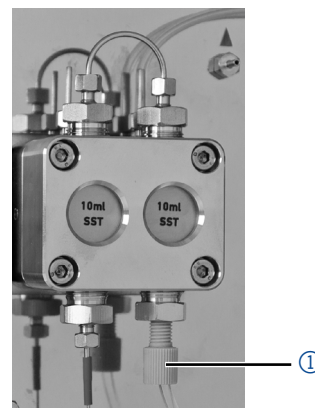

Fig. 8: Solvent line on pump head

Next step Integrate the pump into the HPLC system.

4.6 Control

The pump can be operated in two ways:

- Via the pin header (Analog-In connection with WAGO plug)
- As part of a LAN, via the LAN connector of the router

All connectors for external control are located on the rear side of the pump.

Legend

- ① Events connector
- ② LAN connector
- ③ RS-232 port
- ④ Remote connector

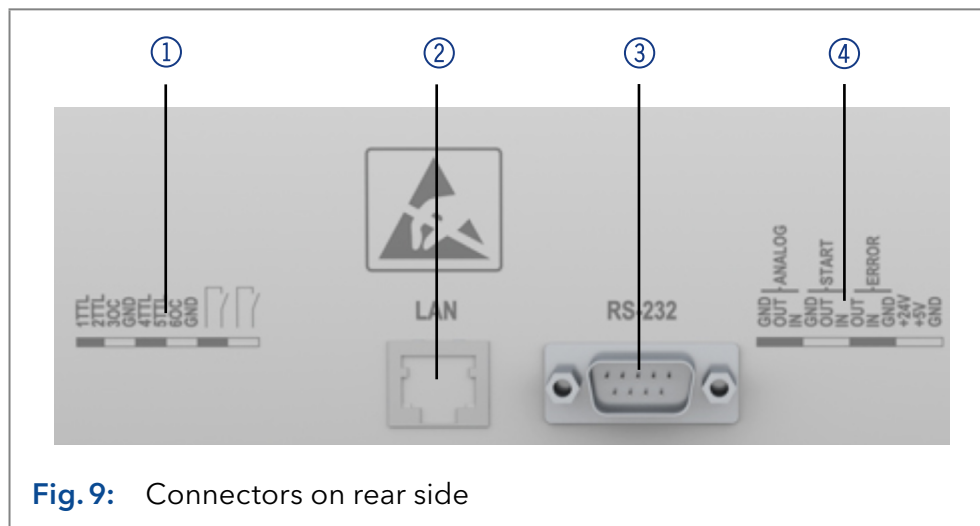

Fig. 9: Connectors on rear side



Note: HPLC devices from KNAUER only work with IP addresses, which have been assigned by IPv4. IPv6 is not supported.

This chapter describes how to set up a chromatography system in a local area network (LAN) and how a network administrator can integrate this LAN into your company network. The description applies to the operating system Windows® and all conventional routers.



Note: When using PurityChrom®, static IP addresses are needed (see chapter 4.7 on page 20).

4.6.1 Setting up LAN

To set up a LAN, we recommend to use a router. That means the following steps are required:

Procedure

Process

1. On the computer, go to the control panel and check the LAN properties.
2. Hook up the router to the devices and the computer.
3. Set up the router for the computer network.
4. Install the chromatography software.
5. Switch on the device and run the chromatography software.

Next steps Configure LAN properties (see chapter 4.6.2 on page 18).

4.6.2 Configuring LAN settings

The LAN uses only one server (which is normally the router) from that the devices automatically receive their IP address.

Prerequisites

- In Windows, power saving, hibernation, standby, and screen saver must be deactivated.
- In case you use an USB-to-COM box, the option "Allow the computer to turn off this device to save power" in the device manager must be deactivated for all USB hosts.
- Applies to all LAN devices: Disable the setting for the network adapter in device manager "Allow the computer to turn off this device to save power".

Process

Procedure

1. In Windows, open <Network and Sharing Center>.
2. Double-click on <LAN connection>.
3. Click on the button <Properties>.
4. Select <Internet Protocol version 4 (TCP/IPv4)>.
5. Click on the button <Properties>.
6. Check the settings in the tab <General>. The correct settings for the DHCP client are:
 - a) Obtain an IP address automatically
 - b) Obtain DNS server address automatically
7. Click on the button <OK>.

Next steps Connect devices (see chapter 4.6.3 on page 18).

4.6.3 Connecting devices with LAN

A router ② has several LAN ports ③ and one WAN port ④ that can be used to integrate the LAN into a wide area network (WAN), e.g. a company network or the Internet. In contrast, the LAN ports serve to set up a network from devices ① and a computer ⑤. To avoid interference, we recommend operating the chromatography system separately from the company network.



Note: You will find patch cables for each device and the router in the accessories kit. To connect the router to a LAN, an additional patch cable is required, which is not supplied within the scope of delivery.

Legend

- ① Devices
- ② Router
- ③ LAN ports
- ④ WAN/Internet connection
- ⑤ Computer

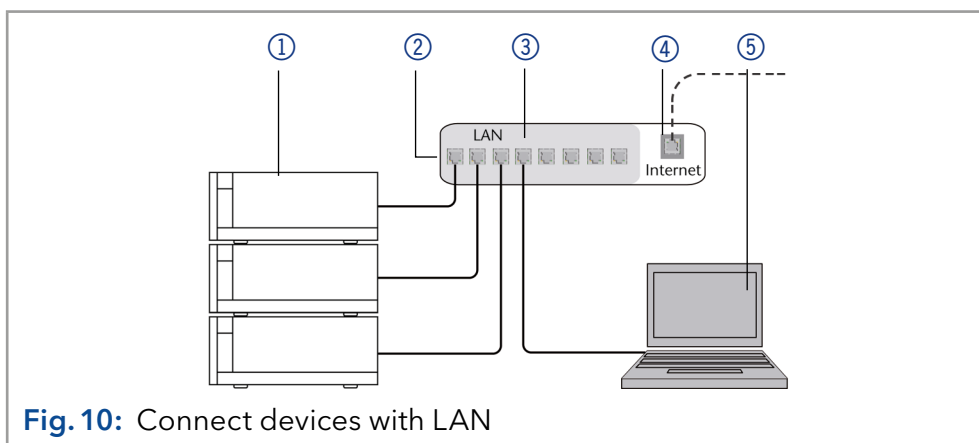

- Prerequisites**
- The computer is switched off.
 - There is a patch cable for each device and the computer.

Process**Procedure**

1. Use the patch cable to connect the router and the computer. Repeat this step to connect all devices.
2. With additional patch cables, connect all devices individually with the router.
3. Use the power supply to connect the router to the mains power system.

Next steps Set the router properties (see chapter 4.6.4 on page 19).

4.6.4 Configuring the router

The router is preset at the factory. Information about address, user name and password is noted in the router manual: www.knauer.net/router.

Process**Procedure**

1. To open the router configuration, start your Internet browser and enter the IP address (does not apply for all routers).
2. Enter user name and password.
3. Configure the router as DHCP server.
4. In the router configuration, check the IP address range and make changes if necessary.



Note: If the IP address range has been changed, it is essential to note this information on the router.

Result Once the router has assigned IP addresses to all devices, the chromatography software can be used to remotely control the system.

4.6.5 Integrating LAN into the company network

A network administrator can integrate the LAN into your company network. In this case you use the WAN port of the router.

Prerequisites ■ There is a patch cable for the connection.

Process

Procedure

1. Make sure that there is no overlap between the IP addresses of the router and the corporate network.
2. In case of an overlap, change the IP address range of the router.
3. Use the patch cable to connect the router WAN port to the company network.
4. Restart all devices, including the computer.

Result The LAN is now integrated into the company network.

4.6.6 Controlling several systems separately in LAN

Devices connected to a LAN communicate through ports, which are part of the IP address. If more than one chromatography systems are connected to the same LAN and you plan on controlling them separately, you can use different ports to avoid interference. Therefore, the port number for each device must be changed and this same number must be entered into the device configuration of the chromatography software. We recommend to use the same port number for all devices in the same system.



Note: The port is set to 10001 at the factory. You must use the same numbers in the device configuration of the chromatography software as in the device, otherwise the connection fails.

Process

Procedure

1. Find out port number and change it on the device.
2. Enter the port number in the chromatography software.

Result The connection is established.

4.7 Setting IP addresses via software



Note: Check the IT security standards for your lab before intervening in the LAN settings.

PurityChrom® Static IP addresses are required to run certain chromatography software, e.g. Purity Chrom®. For a comprehensive overview on how to set static IP addresses for PurityChrom®, refer to the document „PurityChrom® Installation Guide“ on the PurityChrom® installation CD.

For Mobile Control and Firmware Wizard, it is possible to set a fixed (static) or dynamic (DHCP) IP address via software.

4.7.1 Firmware Wizard: Setting a static IP address



Note: More information about LAN settings can be found in the Mobile Control Software Instructions in the chapter "Firmware Wizard" (document no. V6851-2).

Legend

- ① Text box for serial number of the device
- ② Setting IP address manually
- ③ Text box for IP address
- ④ Text box for subnet mask & gateway
- ⑤ Confirm changes

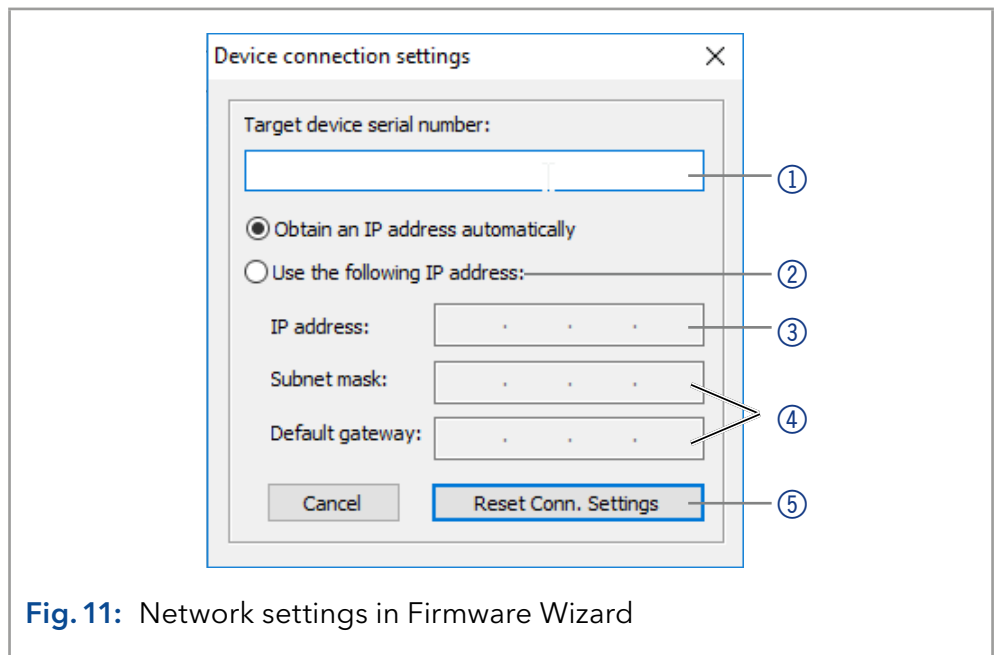

Fig. 11: Network settings in Firmware Wizard

Prerequisites

- The device is switched on.
- Firmware Wizard is installed and running.
- The connection between Firmware Wizard and the device has been established.

Process

Procedure

1. In Firmware Wizard, click <Reset LAN Settings...>.
2. The window <Device connection settings> opens. Enter serial number of the device into the text field <Target device serial number> ①.
3. Select option <Use the following IP address> ②.
4. Enter the IP address into the text field <IP address> ③.
5. Optionally, adjust subnet mask and gateway ④.
6. Click <Reset Conn. Settings> ⑤ to accept changes.
7. Restart the device (recommended).

Result The device is now accessible via the static IP address.

4.7.2 Firmware Wizard: Setting a dynamic IP address

Prerequisites

- The device is switched on.
- Firmware Wizard is installed and running.
- The connection between Firmware Wizard and the device has been established.

Process

Procedure

1. In Firmware Wizard, click <Reset LAN Settings...>.
2. The window <Device connection settings> opens. Enter serial number of the device into the text field <Target device serial number> ① .
3. Select option <Obtain an IP address automatically> ② .
4. Click <Reset Conn. Settings> ⑤ to accept changes.
5. Restart the device (recommended).

Result The device is now accessible via a dynamic IP address.

5. Operation

5.1 Initial operation

Use this checklist to check if the pump is ready for initial operation:

- Device is positioned in the correct location.
- The power plug has been connected.

If the device is part of an HPLC system, you should also note the following:

- The network connection to the router is established.
- The chromatography software has been installed by KNAUER or a company authorized by KNAUER.
- The capillaries have been connected.



Note: Prior to switching on the pump, you should purge it to remove air from capillaries and tubings (see chapter 5.2 on page 24).

5.1.1 Pump head running-in



Note: It is mandatory to perform a running-in procedure after a pump head maintenance, or if new pump heads are installed on a pump.

All pump heads were filled with isopropanol prior to delivery. Make sure to connect the correct solvent as described in the specification table found in the supplement „[Running-In procedure for pump heads](#)“ (V6894).

If a pump was not in operation for a long time, e.g. after shipment, a running-in procedure might be necessary to obtain the best pump performance. The pump head underwent this procedure during the manufacturing process.

If the pump is performing within specification, or during intensive operation, it is not necessary to perform this procedure.

NOTICE

Component defect

Damage to the pump head in case running-in procedure was not performed correctly.

- ➔ Set the correct backpressure and flowrate for the running-in procedure of the pump head. Specific running-in parameters and the general procedure can be found in the supplement „[Running-in procedure for pump heads \(V6894\)](#)“.

NOTICE

Device defect

If the pump is operated only with pure distilled water, significantly higher wear of the piston and the piston seals can be expected.

- ➔ If possible, only operate the pump with water together with the added additive or modifier.

5.1.2 Isocratic operating mode

- Analysis without gradients
- The solvent composition is constant during the analysis.
- The solvent can be recycled.

5.1.3 Optimizing HPLC separations

To make your HPLC separations as efficient as possible, pay close attention to the following:

Task	Explanation
Avoiding additional dead volumes	<ul style="list-style-type: none"> ■ Once they have been used, never re-use capillaries in other areas of the HPLC system. ■ Only use a given PEEK fitting for one specific port and never re-use it for other ports. Always install new PEEK fittings on each separate port.
Using special columns	Use special columns and follow the manufacturer's instructions on caring for the columns.
Checking for clogged capillaries	Regularly check for clogged capillaries - test back pressure without column!
Using filtered solvents	<ul style="list-style-type: none"> ■ Use ultra-pure, filtered solvents - gradient grade - for the HPLC. ■ Filtration of substances to be analyzed. ■ Use of inline filters.

5.2 Purging the pump

NOTICE

Column defect

Damage to the column due to purging.

- Open the venting screw.
- Remove the column.

Before the pump can be used, it must be purged to remove excess air in the capillaries.

Flush the pump in the following cases:

- | | |
|----------------------------------|--------------------------------------------------------------------------------------------------------------------------------------------------------------------------------------------------------------------------------------------------------------------------------------------------------------------------|
| When is purging required? | <ul style="list-style-type: none"> ■ At initial startup to eliminate air bubbles in hoses and capillaries. ■ When changing solvents. ■ After using buffer solutions to eliminate salt residues. ■ Before turning off, if you do not plan to restart the device within shortly. |
| Prerequisites | <ul style="list-style-type: none"> ■ The installation has been completed. ■ The capillaries and tubings have been connected. |

- The pump has been switched on and is in „flow mode“.

Tool ▪ Syringe with Luer lock

Use the purging solvent used in the following applications.

Note: The purging process may take a while during initial operation because the solvent tubes are filled with liquid for the first time.

Note: If a buffer solution is used, pay attention to choose a solvent for purging in which the buffer solution is soluble.

Procedure

Process

1. Open the venting screw ② of the pressure sensor.
2. Connect the syringe with the silicone tubing to the outlet ①.
3. Press the purging button  to open the purging mode and select respective gradient and flow.
4. With the syringe, extract fluid through the purge port ①.
5. If the extracted fluid flows continuously, stop suction and close the venting screw ②.

Figure

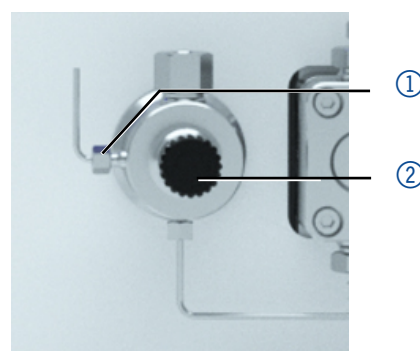

Fig. 12: Venting screw of the pressure sensor

The purging process of the pump is limited to a maximum pressure of 5 MPa. If this value is exceeded during the purging process, the pump switches off automatically. If you are using very small hoses and capillaries, the pressure can be too high.

5.2.1 Piston backflushing

The pump is equipped with automatic piston backflushing. It increases the service life of the seals and pistons, and removes contaminants from the area behind the seals.

Functional principle

The piston backflushing function automatically flushes the rear piston area of the pump head upon switch-on and in continuous mode.

- Upon switch-on: The rear piston area of the pump head is automatically flushed for 8 seconds.
- In continuous mode: The rear piston area of the pump head is flushed automatically every two hours, for 15 seconds.

Recommended purging solution

Select a suitable solvent in the backpiston flushing. The solvent used for the flushing depends on the application and the used solvent in the pump:

Solvent in the pump	Piston backflushing
Reverse phase solvents	50% isopropanol or ethanol with 50% water (v/v)
Normal phase solvents	100% isopropanol
Buffers with high salt concentrations	Rinse with water containing 5% ethanol or isopropanol.

Legend

- ① Outlet from the pump head to the solvent bottle
- ② Inlet from the solvent bottle to the flush pump
- ③ Outlet from the flush pump to the pump head

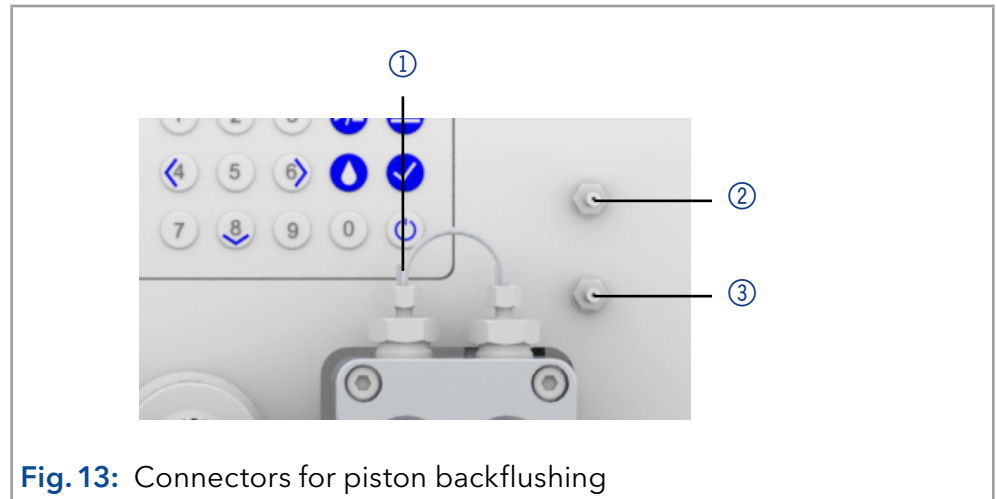

Fig. 13: Connectors for piston backflushing

5.3 Switch on and self test

- Procedure**
1. Switch on the pump.
 2. The display shows *Initialization*. The device runs a self test.
 3. Wait until the self test has been completed.
 4. After the test has been successfully completed, the most recently active program will be displayed.

5.4 Operating with LC display and keypad

The LC display operation of the pump is suitable for the following tasks:

- Monitoring device functions
- Using special programs for laboratory work:
 - Flushing program
 - Standby and *Wake up* (WU) program
 - Program sequences (*Link Menu*)
 - Checking the system status as part of quality assurance measures in accordance with Good Laboratory Practices (*GLP menu*)

Legend

- ① Status LED
- ② Status *Start/Stop*
- ③ Remote control
- ④ Gradient modus
- ⑤ Parameters/Values
- ⑥ RFID recognition of the pump head
- ⑦ Keypad

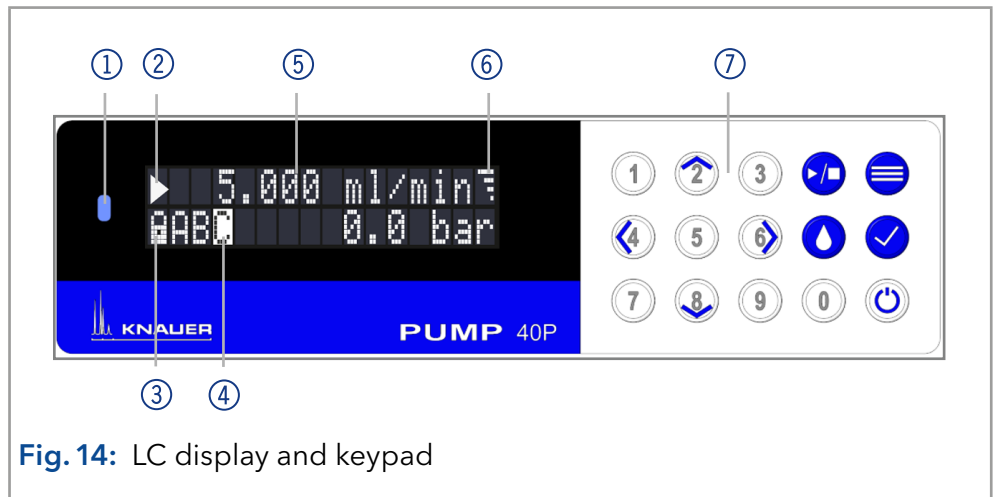









Fig. 14: LC display and keypad

5.4.1 LED status

The status of the device is indicated by an LED on the front side. The color of the LED shows the current status.

LED	Status
	Green Pump is ready (idle status).
	Green flashing Pump is running.
	Yellow Firmware upload in progress.
	Yellow flashing Device initialization
	Red A serious error occured.
	Red flashing An acknowledgeable error occured.
	Blue Device in standby
	Cyan flashing Pump is purging.







5.4.2 RFID icon

The status of a RFID valve is shown on the display in the main display.

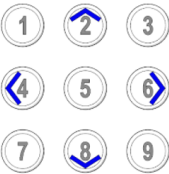
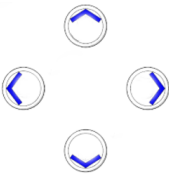
RFID	Status
	Icon RFID tag found.
	Icon flashing RFID tag not found

5.4.3 Operating with the keypad







The keypad consists of 15 buttons which allow to operate the device.

Key	Function	Explanation
	Numeric pad	<ul style="list-style-type: none"> ■ Activation of numeric pad by pressing the <i>Confirmation</i> button at input fields. ■ Changing values.
	Navigation button	<ul style="list-style-type: none"> ■ Navigation through menu with horizontal keys <>. ■ Adjustment of values at input fields with vertical keys ^ v.
	Menu button	<ul style="list-style-type: none"> ■ Select main menu. ■ Return to one menu further up in the menu structure.
	Confirmation button	<ul style="list-style-type: none"> ■ Confirm selection. ■ Entering sub menu. ■ Activation of numeric pad usage at input value.
	Start and stop button	Starts or stops the pump with set values.
	Purge button	Opens purge option.
	Standby button	<ul style="list-style-type: none"> ■ Starts standby mode. ■ Inserts a decimal point if numeric pad is activated.



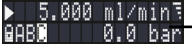

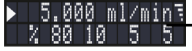
5.5 Menu structure

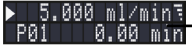
5.5.1 Main menu

The main menu contains the current parameters of the pump.





Process	Figure
1. To navigate between the different main menus, use the horizontal arrow keys   .	 ①
2. In the four main screens the status of the pump is shown. Flow ①, events ②, and gradient composition ③ can be adjusted. In the fourth screen programs and links can be started ④.	 ②
	 ③
3. From here the submenus <i>Setup</i> , <i>GLP</i> , <i>Program</i> and <i>Link</i> can be accessed by using the menu button  .	 ④



Note: If the status *Start*  is displayed on the screen, the pump is not running. By pushing  the pump starts running. If *Stop*  is displayed, the pump is running. Press  to stop the pump.

Navigate through main menu



Procedure

1. Press  to access the menu.
2. Navigate between menu points by using horizontal arrow keys  .
3. Enter submenus using the confirm button .



Note: With the vertical keys, you can increase and decrease the displayed values. If you want to use the numeric pad, simply press the confirm button to activate numeric pad. A decimal point is located on the standby key in case the numeric pad is activated.





Note: If the pump is controlled remotely via software, a lock symbol appears at the lower left edge of the screen. Value entry is blocked, but operation can be interrupted by pressing . By pressing the arrow key  and holding it down, an automatic change of the display of the operating data (flow rate, pressure, gradient) is activated. The alternating display can be deactivated by pressing the arrow key  and holding it down.



5.5.2 Menu structure: overview



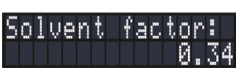

Fig. 15: Menu structure overview

5.5.3 Device setting parameters

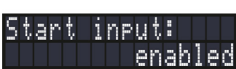
Menu	Explanation	Figure
<p>Cntl. Interface</p>	<p>Setting for external communication connection of the pump. The connections are on the rear side of the device.</p> <ul style="list-style-type: none"> ■ RS232-11520, RS232-38400, RS232-19200, RS232-9600 serial interface ■ LAN-DHCP: Automatic network configuration ■ LAN manual: Manual network-configuration (Port, IP address, IP mask, Gateway) ■ Analog: Manual control of the pump <p>Note: After changing the settings for external communication, the device should be restarted.</p>	
<p>Pr. limits</p>	<p>Settings for the minimum and maximum pressure. The pump stops automatically if the pressure drops below the minimum value or exceeds the maximum value. The minimum pressure value is used to ensure that the pump does not run dry. If the minimum is set to 0, the minimum system pressure is not monitored.</p>	
<p>Pump head</p>	<p>Pump head selection:</p> <ul style="list-style-type: none"> ■ Automatic detection ■ 10 ml ■ 50 ml <p>Note: Only possible if automatic recognition of the pump head does not function. The selection is used as a basis for calculating the flow rate and determines the max. system pressure. This value applies for all operating modes and cannot be exceeded.</p>	

Solvent factor	<p>Data entry for the compressibility of the selected solvent:</p> <ul style="list-style-type: none"> ■ Water: 0.46 ■ Benzene: 0.95 ■ Chloroform: 0.97 ■ Ethanol: 1.10 ■ Acetone: 1.23 ■ Methanol: 1.21 ■ n-heptane: 1.40 ■ n-hexane: 1.50 ■ Diethyl ether: 1.84 ■ Acetonitril: 0.99 ■ Tetrahydrofuran: 0.93 ■ Water/methanol (10/90): 1.17 ■ Water/methanol (20/80): 0.86 ■ Water/methanol (40/60): 0.56 ■ Water/methanol (50/50): 0.52 ■ Water/methanol (60/40): 0.46 ■ Water/methanol (80/20): 0.40 ■ Water/methanol (90/10): 0.34 	
Dosing mode	<p>When operating the device continuously as a dosing pump, this operating mode must be used. When the maximum operating hours of the motor (5000 h) are reached, a warning message is displayed. Then the device must be maintained by a service technician.</p>	
Start input	<p>After receiving a signal from an external device, the device or a program starts an automatic run. The software sends a trigger signal via LAN.</p> <p>There are four possible settings:</p> <ul style="list-style-type: none"> ■ Enabled: Program starts. ■ Disabled: No program starts. ■ Start pump: Pump starts a run. ■ Stop pump: Running pump stops. 	

<p>Grad mode</p>	<p>Setting of high pressure gradient (HPG) and isocratic system:</p> <ul style="list-style-type: none"> ■ Select type: <ul style="list-style-type: none"> – HPG-A to HPG-D – None (isocratic) ■ Channel A-D: ON/OFF activates up to four channels <p>Note: The gradient mode is displayed as A, B, C or D with filled background in the lower left area of the main window.</p>	
<p>Analog output setup</p>	<p>Output of analog pump signals to external devices by means of the remote terminal strip:</p> <ul style="list-style-type: none"> ■ Offset data entry for the analog output ■ Full Scale Voltage range options: 1 V, 2 V, 5 V ■ Signal source <ul style="list-style-type: none"> – Pressure preset for the output of the currently measured pressure for the purpose of external recordings or control – Slave B for the output of a signal for controlling a second pump – HPG/LPG-A to HPG/LPG-D – Disabled ■ Time constant OUT: Set the time constant for analog output to be used for signal smoothing. The larger the value of the selected time constant, the stronger the applied signal smoothing. 	

Analog input setup

Note: Before operating this configuration, change to the network configuration and set the external communication port of the pump to *Analog* (see Cntl. Interface).

Configure the analog input of the remote port for external flow control:

- Actual interpreted flow: 0.000 ml/min
- Procedure: Set to Zero
- Define an applied input voltage as zero point with the flow rate of 0.000 ml/min. If a deviating positive control voltage is applied, a resulting flow rate at actually interpreted flow, based on the basic setting, is displayed:
 - 1 ml corresponds to 1 V for the 10 ml pump head
 - 5 ml corresponds to 1 V for the 50 ml pump head
 - Flow rate value can be changed. This creates a second calibration point which modifies the scaling.
- Time constant: Set the time constant for the analog input to be used for signal smoothing (0.1-10.0 S). The greater the value of the selected time constant, the stronger the applied signal smoothing.



Event check

Testing the terminal strip events.



- Start-IN and Error-IN: Status at the digital inputs.
- Active only: Connects Event 1 to Event 8 and 24 V.



5.6 GLP menu

In the *GLP* menu, statistical data on important parameters of the pump are displayed.

Navigate through *GLP* menu





- Procedure**
1. Use the horizontal keys   to navigate through the submenu.
 2. If no buttons are pressed, the display returns to the main menu after a short time.
 3. The menu contains no editable parameters.

5.7 Program menu

The menu *Program* is used to list and create programs. The pump can save up to 19 programs and up to 100 program lines with the following functions:

- Controlling the flow rate
- Controlling the solvent composition
- Sending control signals (Events)

Navigate through *Program* menu

- Procedure**
1. Open a program number of your choosing.
 2. Use the horizontal arrow keys   to navigate through the two lines of the display.
 3. To change a value press  and change the value by the numeric pad.
 4. Move the cursor to the double arrow  on the lower left line to navigate to the next line or create a new line.









Note: The maximum pressure for the program can be changed. It can differ from the default one and is thereby only valid for this program.

5.7.1 Create program

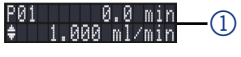
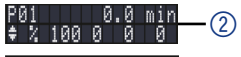
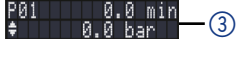
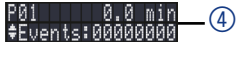
The use of the display is demonstrated using the example of a program to be created:









Program 01 is used to create a solvent gradient (channels A and B) with constant flow of 1 ml/min. The percentage of solvent A is to be continuously decreased from 100% to 0% within 0.50 minutes.

Process	Figure
1. Select the <i>Device program</i> menu.	
2. Select the desired program number.	
3. The parameters for time 0.0 min can be changed by navigation with the horizontal keys   to the different parameters like time/flow ①, gradient composition ②, maximum pressure ③ and events ④.	   

4. Navigate to the double arrow  on the lower left side of the display and press the downward key  to create a new line.
5. Enter the time value of the new line and adjust the respective parameters.
6. Press  for two seconds to exit the submenu. The program is automatically saved.



5.7.2 Run program

Process	Figure
<ol style="list-style-type: none"> 1. Navigate to the program main screen via the horizontal arrow keys  . 2. Move the cursor to the area behind the P, press  and type in the program number via the numeric pad. 3. Upon entering the program number, the pump will start pumping in status <i>Hold</i>, indicated by the letter H at the upper left corner. 	
<ol style="list-style-type: none"> 4. Navigate the cursor with the horizontal keys to the status symbol and press the upward key  to change the status from <i>Hold</i> (H) to <i>Run</i> (R). The program starts running. 	
<ol style="list-style-type: none"> 5. After the program has been completed, the display switches into the status <i>End</i> (E). 6. Press  to stop the pump. 	

5.7.3 Change program



When new values for the different program lines are entered, the old values are overwritten.

- Procedure**
1. Select the menu *Program*.
 2. Select a program number.
 3. Navigate to the desired line and value.
 4. Activate the numeric pad by pressing  and enter a new value.

5.7.4 Delete program lines





- Procedure**
1. Select the menu *Program*.
 2. Select the desired program number.
 3. Navigate to the to be deleted program line.
 4. Change the time value of the line to 0.000.
 5. Confirm with .

5.7.5 Delete a program

Process	Figure
<ol style="list-style-type: none"> 1. Select the menu <i>Program</i>. 2. Select the program 00. 3. Activate the numeric pad by pressing  and enter the program number you wish to delete. 4. You will be asked whether you really want to delete the program. Confirm with the confirm key or deny with . 	

5.7.6 Create a program with a starting time





The pump can start a program at a preset time (*Wake Up* program). The pump starts the selected program at the specified time and date. The display switches from standby to run mode.

Process	Figure
<ol style="list-style-type: none"> 1. Select the menu <i>Program</i>. 2. Enter program number 20. 3. Enter the time, date and program number you wish to start by navigation with the horizontal keys   and activate the numeric pad by pressing . 4. To run the <i>Wake Up</i> program follow the procedure as if running any other program. Upon choosing program 20 the pump will go into standby until the set wake up time and date. 	



5.8 *Link* menu

The *Link* menu displays the status of active links. A maximum of ten program links between defined programs can be created and saved.

Navigate *Link* menu

- Procedure**
1. Open the desired link number.
 2. Use the horizontal arrow keys   to navigate through the two lines of the display.
 3. To change a value use the vertical arrow keys   or press  and change the value by the numeric pad.
 4. Move the cursor to the double arrow on the lower left line to navigate to the next line or create a new line.

5.8.1 Create link





Process	Figure
<ol style="list-style-type: none"> 1. Select the <i>Link</i> menu. 2. Enter the link number. 3. Press  to enter the editing mode of the link. 4. Move the cursor to position P in the display and enter the program number you wish to run. 5. Move the cursor to position R (<i>Repeat</i>) and enter the number of repetitions for the specified program. 6. Move the cursor to position W in the display and enter 1 or 0. 	





Note: If W1 (W = *Wait*) is used, the pump waits for an external start signal or for the user to press the upward key to set the status to run before executing this line. If the W0 setting is used, the link sequence runs without interruption.

5.8.2 Run link

After the link has been completed, the display switches to the end mode.

- Procedure**
1. Go to the main menu.
 2. Navigate to *Link/Program* in the lower left display line and choose *Link* with the vertical arrow key  .
 3. Enter a link number.
 4. The pump status switches to the *Hold* status (HLD) and starts pumping with the initial flow rate of the program.
 5. Navigate to the pump status and press the up arrow key  to set the pump into a *Run* status (RUN).
 6. The link will start running the programs.
 7. Use the down arrow key  with the cursor on the pump status to pause the execution of the link (Status: HLD).
 8. Press the up arrow key to resume the run (Status: RUN).

5.8.3 Delete link

Process	Figure
<ol style="list-style-type: none"> 1. Select the menu <i>Link</i> and choose the link 00. 2. Activate the numeric pad by pressing  and enter the desired program number you wish to delete. 3. Confirm or deny with . 	

6. Functionality tests



Note: Standard processes regarding IQ and OQ in single devices may be handled differently in individual cases.

6.1 Installation Qualification (IQ)

The customer may request the Installation Qualification, which is free of charge. In case of a request, the technical support of KNAUER or a provider authorized by KNAUER performs this functionality test during the installation.

The Installation Qualification is a standardized document that includes the following:

- confirmation of flawless condition at delivery
- check if the delivery is complete
- certification on the functionality of the device

You can either use the IQ document attached to this instruction manual or download a digital version from our website:



6.2 Operation Qualification (OQ)

The Operation Qualification includes an extensive functionality test according to KNAUER standard OQ documents. The Operation Qualification is a standardized document and free of charge. It is not part of the delivery. Please contact the technical support in case of a request.

The Operation Qualification includes the following:

- definition of customer requirements and acceptance terms
- documentation on device specifications
- device functionality check at installation site

Test intervals To make sure that the device operates within the specified range, you should test the device regularly. The test intervals depend on the usage of the device.

Execution The test can be carried out either by the technical support of KNAUER or by a provider authorized by KNAUER (for a fee). For further information visit our website:



7. Troubleshooting

First measures:

- Check all cables and fittings.
- Check if air has gotten into the supply lines.
- Check the device for leakages.

Further measures:

- Compare occurring errors with the list of possible errors (see below).
- Contact the Customer Support.

7.1 LAN

Go through the following steps, in case no connection between the computer and the devices can be established. Check after each step if the problem is solved. If the problem cannot be located, call the Technical Support.

1. Check the status of the LAN connection in the Windows task bar:



If no connection was established, test the following:

- Is the router switched on?
 - Is the patch cable connected correctly to the router and the computer?
2. Check the router settings:
 - Is the router set to DHCP server?
 - Is the IP address range sufficient for all the connected devices?
 3. Check all connections:
 - Are the patch cable connected to the LAN ports and not the WAN port?
 - Are all cable connections between devices and router correct?
 - Are the cables plugged in tightly?
 4. If the router is integrated into a company network, pull out the patch cable from the WAN port.
 - Can the devices communicate with the computer, even though the router is disconnected from the company network?
 5. Turn off all devices, router, and computer. First switch on the router and wait until it has successfully completed its self-test. Firstly, turn on the router and secondly turn on the devices and the computer.
 - Has this been successful?
 6. Replace the patch cable to the device with that no connection could be established.
 - Has this been successful?
 7. Make sure that the IP port of the device matches the port in the chromatography software.

7.2 Possible problems and solutions

Issue	Solution
Device cannot be switched on.	Inspect the power cable to ensure that it is plugged into the power supply.
When purging, the pump switches off.	Check if the venting screw on the pressure sensor is opened.
Pump does not transport solvent.	<ul style="list-style-type: none"> ■ Purge the pump head to remove the air bubbles. ■ Inspect the eluent filter of the HPLC column and change when blocked. ■ Exchange the pump head. ■ Clean the check valves. ■ Exchange the check valves. ■ If the pump head seals are defective, solvent enters the piston backflushing; inform the technical support. ■ Pump head maintenance is required.
Pressure and flow rate variations	<ul style="list-style-type: none"> ■ Purge the pump head to remove the air bubbles. ■ Always tighten the inlet screw fittings and outlet screw fittings on the pump head with a torque wrench (see chapter 8.3 on page 45). ■ Clean the check valves. ■ Exchange the check valves. ■ Exchange the pump head. ■ Inform Technical Support.
Pump head leaks.	<ul style="list-style-type: none"> ■ Inspect the inlet and outlet screw fittings of the pump head. ■ If the seals are defective, eluent enters the piston backflushing; inform the Technical Support. ■ Exchange the pump head.
Flow rate is not correct.	<ul style="list-style-type: none"> ■ Check the data for the solvent compressibility. ■ Clean the check valves. ■ Exchange the check valves.
System failure	Switch off the device to reset the device's data storage and restart it afterwards.

7.3 System messages

If other system messages are displayed on the display besides those listed below, please turn the device off and then on. Inform the Technical Support in case the system message repeats.

The system messages are in alphabetical order:

System message	
A	Auto pump head type: head data uninitialized!
	<ul style="list-style-type: none"> ■ Switch the device off and on. ■ Check whether a pump head with RFID recognition has been installed. ■ Repeat the automatic configuration step in the chromatography software. ■ Remove pump head, clean it and install it again.
	Auto pump head type: no head detected!
	<ul style="list-style-type: none"> ■ Switch the device off and on. ■ Repeat automatic configuration in the chromatography software. ■ Remove pump head, clean it and install it again. ■ Check whether a pump head with RFID recognition has been installed.
C	Cannot delete active program/link
	Pause active program as well as link and then delete the link.
	Cannot edit program from the running link
	First pause the link, then edit the data on the device display or in the chromatography software.
	Cannot initialize LAN
	Check the cables and connections in the local area network.
	Cannot operate with an empty link
	The link is empty. First create a link.
	Cannot read data from FRAM
	Switch the device off and on. If the system message appears again, notify the manufacturer for Technical Support.
	Cannot read RTC
	Switch the device off and on. If the system message appears again, notify the manufacturer for Technical Support.
	Cannot start time table
	Edit the data on the device display or in the chromatography software.
	Cannot use non-existing component!
	Change the setup settings or change the gradient in the program or in setup.
	Cannot write data on FRAM
	Switch the device off and on. If the system message appears again, notify the manufacturer for Technical Support.

System message	
E	Error input activated Device error; change device settings.
G	GUI communication failed (internal)! Switch the device off and on. Inform the Technical Support in case the system message repeats itself.
I	Insufficient access Change the entry.
	Invalid command <ul style="list-style-type: none"> ■ Change the entry. ■ Check the cable connections.
	Invalid parameter(s) Check the validity of the parameter(s).
	Invalid time in time table Correct the time entry.
	Invalid time table index Change the entry in the program line.
L	Link is loaded First unload the link then change the link or delete it.
	Link is running Wait until the link has been completed, then change the link or delete it.
M	Maximum pressure! System stopped <ul style="list-style-type: none"> ■ Reduce the pressure or adjust the upper pressure limit. ■ Restart the system.
	Minimum pressure! System stopped <ul style="list-style-type: none"> ■ Increase the pressure or adjust the lower pressure limit. ■ Restart the system.
N	No components are available in isocratic mode Since the pump can only be operated using a specific valve, the entered data has to be adapted to isocratic mode.
	No link available Create a link and edit it.
	No link available Pls edit link first Create a link and edit it.
	No time table to start Edit the data by means of the chromatography software.
	Non-existing component is set to non-0 value Switch on the channel or edit the data using the chromatography software.
Not enough space to store link <ul style="list-style-type: none"> ■ Check the pump. ■ Check the number of program lines - a maximum of 100 program lines are possible. 	

System message	
	<p>Not enough space to store program</p> <ul style="list-style-type: none"> ■ Check the pump. ■ Check the number of program lines. A maximum of 100 program lines are possible.
	<p>Not supported</p> <p>Change the entry.</p>
P	<p>Prg not compatible with pump head!</p> <p>Modify the program or replace the pump head.</p>
	<p>Program does not exist</p> <p>Create and edit a program.</p>
	<p>Program is running</p> <p>Quit program or wait until program has been completed.</p>
T	<p>The gradient component is used!</p> <p>First unload the program. The setup data can only be edited when no program has been loaded or started.</p>
	<p>This link is used in WakeUp</p> <p>First quit or delete wakeup program (<i>WakeUp</i>), then edit or delete link.</p>
	<p>This program is used in a link</p> <p>First pause or delete link, then edit or delete data by means of the chromatography software.</p>
	<p>This program is used in WakeUp</p> <p>First quit or delete wakeup program (<i>WakeUp</i>), then edit or delete data by means of the chromatography software.</p>
	<p>Time already exists</p> <p>Correct the time entry.</p>
	<p>Time table line is empty</p> <p>Edit the program line.</p>
	<p>Too many lines in program</p> <p>Check the number of program lines. A maximum of 100 program lines are possible.</p>
U	<p>Unknown pump head type!</p> <ul style="list-style-type: none"> ■ Check the pump head. ■ Check whether a pump head with RFID recognition has been installed.
	<p>used!*/, CRC failed</p> <p>Switch the device off and on. If the system message appears again, notify the manufacturer for Technical Support.</p>
W	<p>Wrong Line number</p> <p>Change the line index in the link.</p>
	<p>Wrong link</p> <ul style="list-style-type: none"> ■ Check link number. Values from 1-10 are possible. ■ Correct the entry.

8. Maintenance and care

Maintenance of a HPLC instrument is critical to the success of analyses and the reproducibility of results. If you require a maintenance task which is not described here, contact your dealer or the Customer Support.

8.1 Maintenance contract

The following maintenance work on the device may only be performed by KNAUER or a company authorized by KNAUER and is covered by a separate maintenance contract:

- Opening the device or removing housing parts

NOTICE

Electronic defect

Performing maintenance tasks on a switched on device can cause damage to the device.

→ Switch off the device.

→ Pull the power plug.

Users may perform the following maintenance tasks themselves:

- Replacing the pump head
- Replacing the check valves of the pump head

8.2 Cleaning and caring for the device

All smooth surfaces of the device can be cleaned with a mild, commercially available cleaning solution, or with isopropanol.

Keypad The keypad can be cleaned with isopropanol and wiped dry with a soft, lint-free cloth.

NOTICE

Device defect

Intruding liquids can cause damage to the device.

→ Place solvent bottles next to the device or in a solvent tray.

→ Moisten the cleaning cloth only slightly.

8.3 Checking the fittings

Check if all fittings are tight. In case you find fittings that are not tight, tighten them up. Note the torque applicable for each fitting in order to not damage any components.

Material & size	Pump head inlet	Pump head outlet
Stainless steel 5 ml	7.5 Nm	10 Nm
Stainless steel 10 ml, 50 ml	7.5 Nm	7.5 Nm

Inline filter fittings	Torque
Stainless steel fittings	7.5 Nm
PEEK fittings	3.5 Nm

Capillary screw fittings	Torque
Stainless steel fittings	5 Nm
PEEK fittings	1 Nm

8.4 Flushing the pump

Generally, the pump and all its components should be flushed after each operation. Also, flush the pump to clean the tubing before changing the solvent and to remove air bubbles in the capillary and tubing. If buffer solution has been employed, note that the buffer solution and the flushing solution are compatible.

- When buffers have been used, flush with water.
- When aggressive solvents have been used, flush with isopropanol.



Note: For applications with normal phase, only use isopropanol as flushing solution.

- Materials**
- Flushing solution
 - Silicone tubing

Procedure

Process

1. Immerse the solvent tubing into the flushing solution.
2. Plug a silicone tube onto the venting nozzle ① of the pressure sensor.
3. Open the venting screw ②.
4. Start the pump at a medium flow rate.

Figure

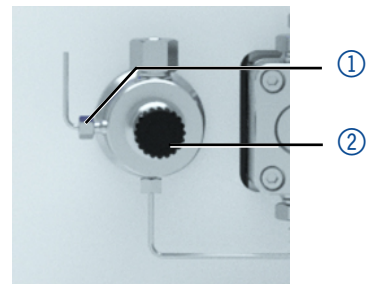

Fig. 16: Pressure sensor

Next step Bring the pump into operation again.

8.5 Maintaining the pump head

8.5.1 Dismounting the pump head

- Prerequisites**
- The pump head has been purged.
 - The tubes at the inlet and outlet have been removed.
 - The pump head's inlet and outlet have been sealed with cap fittings.

- Tools**
- Allen wrench 3 mm
 - Open-end wrench, size 1/4"
 - Open-end wrench, size 13

⚠ WARNING

Chemical burns

Skin damage from aggressive or toxic eluents.

- ➔ Wear protective gloves.
- ➔ Flush the pump head before changing.

NOTICE

Device defect

Residuals chemicals can damage the pump head if they are not being removed before storage.

- ➔ For reuse, flush the pump head and fill it with isopropanol.
- ➔ Before storage, seal the inlets and outlets with cap fittings.

NOTICE

Component defect

Possible damage to the pump piston by tilting the pump head.

- ➔ Tighten diagonally opposite fastening screws evenly one turn at a time.
- ➔ Also loosen the fastening screws evenly.



Note: The back plate of pump head AHB40CA (pump APC30EE) is made of ceramics and is sensitive to shocks. The back plate is no spare part and excluded from guarantee!

Procedure

Process

Figure

1. Loosen the finger-tight fitting ③. Remove the tubing ④.
2. Fixate the outlet fitting ① with an open-end wrench (size 13).
3. Loosen the fitting ② with an open-end wrench (size 1/4"). Remove the capillary.

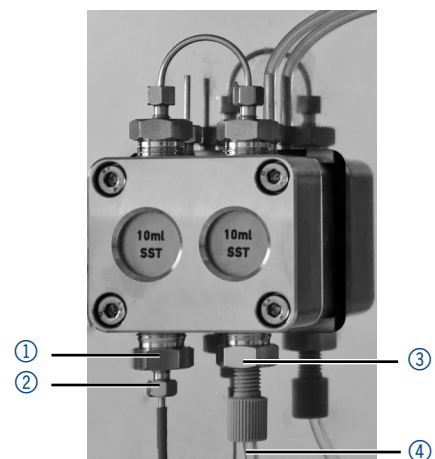

Fig. 17: Outlet screw fitting

Procedure	Process	Figure
	<p>4. Disconnect the tubing of the piston backflushing ① from the flush pump and the pump head.</p>	
	<p>5. Using the Allen wrench, unscrew the 4 screws ① subsequently by one turn.</p> <p>6. Fixate the pump head with your hand and remove the screws.</p> <p>7. Lift off the pump head.</p>	

Fig. 18: Tubings piston backflushing

Fig. 19: Screws

Next step Maintain the check valves (see next section) or install a new pump head.

8.5.2 Check valves

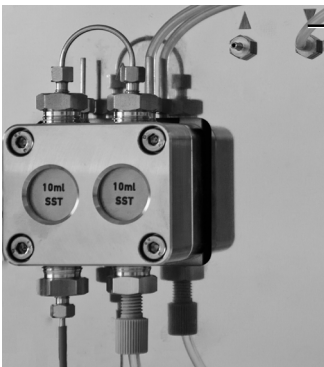
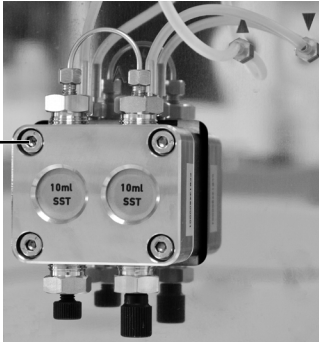
Clogged check valves do not open and close properly. They cause pressure fluctuations and irregular flow. If it is impossible to clean the check valves, replace the whole unit.

- Procedure**
- Removing the check valves
 - Cleaning the check valves
 - Installing the check valves

8.5.2.1 Removing the check valves

The pump head is equipped with two check valves.

- Prerequisites**
- The pump head has been purged.
 - The capillaries and tubings have been removed.
 - The pump head has been removed.

- Tool**
- Open-end wrench, size 13

Procedure	Process	Figure
	<ol style="list-style-type: none"> 1. Unscrew and remove the capillary connector ①. 2. Loosen the outlet fitting ② with the open-end wrench. 3. Remove the first check valve. 4. Loosen the inlet fitting ③ with the open-end wrench. 5. Remove the second check valve. 	

Fig. 20: Check valve in pump head

Next step Clean the check valves.

8.5.2.2 Cleaning the check valve

The check valves cannot be disassembled for cleaning but they are cleaned as a unit.

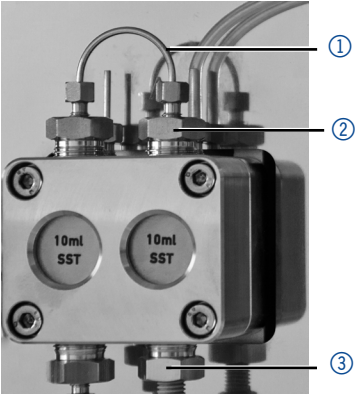
Prerequisite ■ Both check valves have been removed.

Procedure	Process
	<ol style="list-style-type: none"> 1. Place each check valve into a beaker with solvent, e.g. isopropanol. 2. Put the beaker with the check valve in an ultrasonic bath for at least 10 minutes. 3. Let the check valves dry afterwards.

Next step Insert both cleaned check valves.

8.5.2.3 Installing the check valve

NOTICE

Component defect

Damage to components due to excessive tightening possible.

Observe the torque of the screw connection.

→ Use 5 Nm torque for stainless steel fittings.

→ Use 1 Nm torque for PEEK fittings.

Insert the check valves in the direction of the flow. The notch of the check valve points downward.

Normal phase Insert the check valves in the direction of the flow. The arrow on the check valve points upward.

Prerequisite The check valves have dried.

Procedure	Process	Figure
	<ol style="list-style-type: none"> 1. Insert the check valves ① so that the notch of the check valve ② points downward. 2. Manually screw in inlet and outlet fittings and tighten them with a torque wrench and the respective torque. 	

Fig.21: Check valve

Next step Re-install the pump head.

8.6 Maintaining the filter cartridge at pressure sensor

Clogged inline filters inside of the pressure sensor can cause pressure fluctuations and irregular flow. Inline filters are not cleaned but exchanged as an assembly.

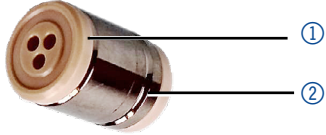

Note: It is recommended to replace the filter cartridge after 5000 working hours.

- Procedure**
1. Remove the capillary above the line filter of the pressure sensor.
 2. Loosen the screw connection of the filter cartridge and unscrew it by hand.
 3. Insert a new filter cartridge.

8.6.1 Removing filter cartridge

The screw connection of the filter cartridge is located above the pressure sensor.

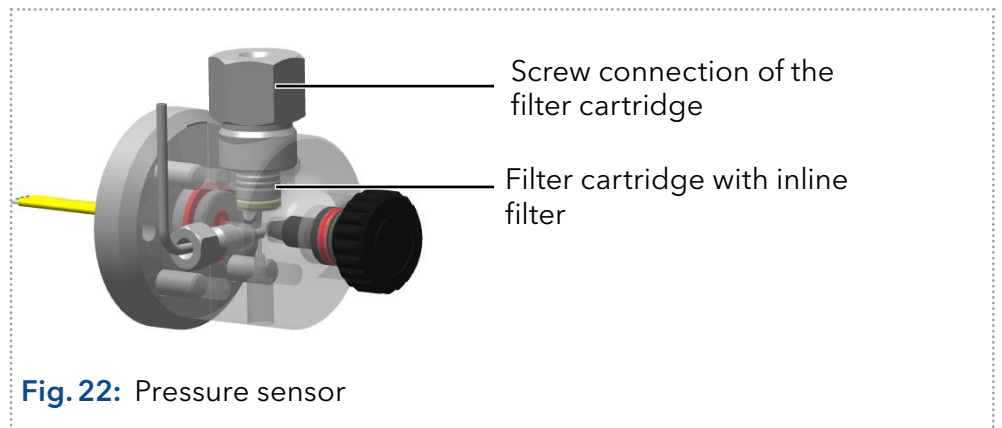

Fig.22: Pressure sensor

- Prerequisite**
- The pump has been purged.
- Tools**
- Open-end wrench, size 1/4"
 - Open-end wrench, size 13
 - Tweezers (optional)

Procedure

Process

Figure

1. Fix the screw connection ① with an open-end wrench (SW 13).
2. Loosen the capillary screw connection ② above the filter cartridge on the pressure sensor with the open-end wrench (SW 1/4").
3. Remove the capillary ③ from the pressure sensor.



Fig. 23: Loosen capillary

4. Loosen the screw connection of the filter cartridge ④ with the open-end wrench (SW 13) and unscrew it by hand.



Fig. 24: Loosen screw connection

5. Remove the polluted filter cartridge ⑤ with the tweezers.

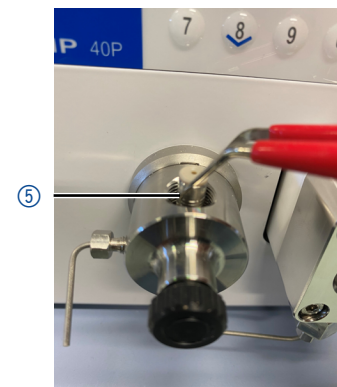

Fig. 25: Removing filter cartridge

Next step Insert a new filter cartridge.

8.6.2 Inserting a new filter cartridge

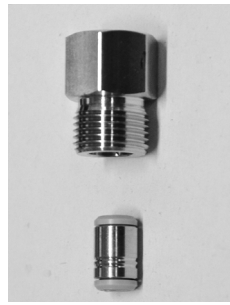

Fig.26: Filter cartridge A96601

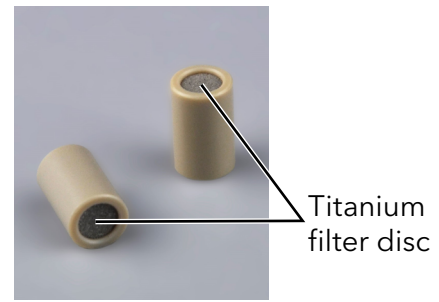

Fig.27: Filter cartridge A9661

Filter cartridges have a marking of the flow direction.

The filter cartridge with article number A96601 (stainless steel) is inserted into the pressure sensor in such a way that the notch as marking always points downwards (s. Fig.26).

The filter cartridge with article number A9661 (titanium, 2 μm , 60 μl volume, for bio-inert variants of the pump) has no markings. With this filter cartridge, the titanium filter disk is clearly visible at the bottom of the cartridge. The side with the filter disk represents the outlet (s. Fig.27).

Tool ■ Torque wrench

Procedure	Process	Figure
	<ol style="list-style-type: none"> 1. Insert the filter cart search ① into the pressure sensor with the marking facing down (A96601) or with the titanium filter disk facing up (A9661). Use the tweezers for this. 	<p>Fig.28: Inserting the filter cartridge A96601</p>
	<ol style="list-style-type: none"> 2. Screw the screw connection ② by hand into the pressure sensor. 3. Tighten the screw connections with the torque wrench to the appropriate torque. 	<p>Fig.29: Tighten screw connection</p>

NOTICE**Component defect**

Damage to components due to excessive tightening possible.

Observe the torque of the screw connection.

→ Use 5 Nm torque for stainless steel fittings.

→ Use 1 Nm torque for PEEK fittings.

Next step Screw the capillary back on the pressure sensor above the screw connection of the filter cartridge.

9. Transport and storage

Regarding the following information, carefully prepare the device for transport or storage.

9.1 Putting the pump out of operation

Prerequisites The device is switched off.

Procedure

Process

1. Pull the power plug out of the socket and then out of the device.
2. Pack the power cable together with the device.

Next steps

- Disconnect all electrical connections.
- Remove the accessories.
- Pack the device for transport or storage.

9.2 Packing the device

- Original packaging: Ideally you should use the original transport packaging.
- Lifting: Grab the device around the center of both sides and lift it into the packaging.

9.3 Transporting the device

Carefully prepare the device for transport or storage. If you want to return your device to KNAUER for repairs, enclose the [Service Request Form](#) which can be downloaded from our website.

Device data For a secure transport, note the weight and dimensions of the device (see chapter 11 on page 57).

CAUTION

Bruising danger

Damage to the device by carrying or lifting it on protruding housing parts. The device may fall and thus cause injuries.

→ Lift the device only centrally on the side of the housing.

Lifting Clasp the device at its side panels and lift it out of the packaging.

9.4 Storing

9.4.1 Storing the device

If the pump is not used for several weeks solvent residues cause damage. Therefore make sure that all tubes and capillaries and pump heads (if they are to remain on the pump during storage) have been drained or filled with flushing solution (e.g. isopropanol) before storage.

To avoid algae formation, do not use pure water. Close all inlets and outlets with blind screwings.

- Prerequisites**
- The pump has been flushed.
 - The pump has been switched off and disconnected from the power supply.

- Tool**
- Open-end wrench, size 10

Procedure

Process

1. Remove the solvent tubing and seal all open connectors with cap fittings.
2. Remove the pump from the HPLC system and seal the open connector of the pressure sensor (isocratic version) or the mixer (binary or quaternary version) with cap fittings.

- Storage conditions** The device can be stored under the ambient conditions described in chapter (see chapter 11 on page 57).

9.4.2 Storing the pump head

NOTICE

Device defect

Residuals chemicals can damage the pump head if they are not being removed before storage.

- ➔ For reuse, flush the pump head and fill it with isopropanol.
- ➔ Before storage, seal the inlets and outlets with cap fittings.

If you want to store pump heads separately, proceed as follows:

- Prerequisite** The pump head has been dismantled (see chapter 8.5.1 on page 46).

- Materials**
- Syringe
 - Flushing solution

Procedure

Process

1. Fill the flushing solution into a syringe and inject into the capillary at the pump head inlet. Leave it for 5 minutes.
2. Flush with suitable purging solution.
3. Fill the pump head with isopropanol.
4. Seal the inlets and outlets with cap fittings.

- Storage conditions** The pump head can be stored under the ambient conditions described in chapter „Technical data“ on page 57.

10. Disposal

Hand in old devices or disassembled old components at a certified waste facility, where they will be disposed of properly.

10.1 AVV-Marking Germany

According to the German "Abfallverzeichnisverordnung" (AVV) (January, 2001), old devices manufactured by KNAUER are marked as waste electrical and electronic equipment: 160214.

10.2 WEEE registration number

KNAUER as a company is registered by the WEEE number DE 34642789 in the German "Elektroaltgeräteregister" (EAR). The number classifies to category 8 and 9, which, among others, comprises laboratory equipment.

All distributors and importers are responsible for the disposal of old devices, as defined by the WEEE directive. End-users can send their old devices manufactured by KNAUER back to the distributor, the importer, or the company free of charge, but would be charged for the disposal.

10.3 Eluents and other operating materials

All eluents and other operating materials must be collected separately and disposed of properly.

All wetter components of a device, e. g. flow cells of detectors or pump heads and pressure sensors for pumps, have to be flushed with isopropanol first and water afterwards before being maintained, disassembled or disposed.

11. Technical data

11.1 Solvent delivery

Pump type	Analytical high pressure pump
Delivery system	Dual piston pump with one working piston, one auxiliary
Pulsation compensation	Active pulsation compensation
Flow properties	<ul style="list-style-type: none"> ■ 10 ml pump head: 0.001–10 ml/min ■ 50 ml pump head: 0.01–50 ml/min
Flow rate range 10 ml pump head	<ul style="list-style-type: none"> ■ 0.001 - 10 ml/min ■ 0.1 - 8 ml/min (recommended) ■ 0.1 - 4 ml/min (continuous operation)
Flow rate range 50 ml pump head	<ul style="list-style-type: none"> ■ 0.01 - 50 ml/min ■ 0.1 - 40 ml/min (recommended) ■ 0.1 - 20 ml/min (continuous operation)
Maximum pressure 10 ml pump head	<ul style="list-style-type: none"> ■ Stainless steel: <ul style="list-style-type: none"> – 65 MPa up to 5 ml/min – 40 MPa up to 10 ml/min ■ Ceramic: <ul style="list-style-type: none"> – 40 MPa
Maximum pressure 50 ml pump head	<ul style="list-style-type: none"> ■ Stainless steel: <ul style="list-style-type: none"> – 30 MPa up to 10 ml/min – 20 MPa up to 50 ml/min ■ Ceramic: <ul style="list-style-type: none"> – 20 MPa
Flow rate accuracy	+/- 1 %, measured at 5 - 80 % of flow range using ethanol
Flow rate precision	< 0.1 % RSD (relative standard deviation) based on retention time at constant room temperature
Residual pulsation	< 2 % amplitude (typically < 1.3 %) or < 0.3 MPa (3 bar), whatever is greater, at 1 ml/min ethanol, at all pressures > 1 MPa (10 bar, 147 psi)
Active piston seal wash	Standard
Gradients	Isocratic HPLC pump
System protection	P_{\min} and P_{\max} adjustable

11.2 Communication

Analog inputs	Flow (0-10 V)
Analog control input	Flow rate
Control	<ul style="list-style-type: none"> ■ LAN ■ RS-232 ■ Remote control connections (Stop, Flow, Pressure, Error) ■ Keypad
Programming	19 programs, 10 program links, 1 WAKE UP program (program 20)

11.3 Technical parameters

Special features	The system pump head is detected automatically using radio frequency identification (RFID)
GLP	RFID pump head recognition, detailed report
Display	LC display with keypad

11.4 General

Supply voltage range	100-240 V
Supply frequency	50-60 Hz
Power consumption	40 Watt
Dimensions (W × H × D)	399 mm × 242 mm × 165 mm
Weight	5.6 kg
Area of use	For indoor use only
Temperature range	4-40 °C (39.2-104 °F)
Line voltage fluctuations do not exceed +/- 10 % of normal voltage.	
Overvoltage category	II
Permitted pollution degree	2
Air humidity	Below 90 %, non-condensing
Operating height	Max. 2000 meters above sea level

12. Chemical compatibility of wetted materials



Note: The user takes the responsibility for using the fluids and chemicals in an appropriate and safe way. If there is any doubt, contact the Technical Support of the manufacturer.

12.1 General

The device is very resistant against a variety of commonly used eluents. However, make sure that no eluents or water come in contact with the device or enter into the device. Some organic solvents (such as chlorinated hydrocarbons, ether) may cause coating damage or loosen glued components by improper handling. Even small quantities of other substances, such as additives, modifiers, or salts can influence the durability of the materials. Exposure time and concentration have a high impact on the resistance.

The following list contains information about the chemical compatibility of all wetted materials which are used in devices made by KNAUER. The data bases on a literature research on the manufacturer specifications of the materials. The wetted materials of this device are listed in the chapter "Technical data".

All resistances mentioned here are for use at temperatures up to 40° C, unless stated otherwise. Please note that higher temperatures can significantly affect the stability of different materials.

12.2 Plastics

Polyetheretherketone (PEEK)

PEEK is a durable and resistant plastic and, next to stainless steel, the standard material in HPLC. It can be used at temperatures up to 100 °C and is highly chemical resistant against almost all commonly used solvents in a pH range of 1-12,5. PEEK is potentially moderate resistant against oxidizing and reducing solvents.

Therefore, following solvents should not be used: Concentrated and oxidizing acids (such as nitric acid solution, sulfuric acid), halogenated acids (such as hydrofluoric acid, hydrobromic acid) and gaseous halogens. Hydrochloric acid is approved for most applications.

In addition, following solvents can have a swelling effect and may have an impact on the functionality of the built-in components: Methylene chloride, THF and DMSO in any concentration such as acetonitrile in higher concentrations.

Polyethylene terephthalate (PET, outdated PETP)

PET is a thermoplastic and semi-crystalline material with high wear resistance. It is resistant against diluted acids, aliphatic and aromatic hydrocarbons, oils, fats and alcohols, but not against halogenated hydrocarbons and ketones. Since PET belongs chemically to esters, it is not compatible with inorganic acids, hot water and alkalis. Maximum operating Temperature: up to 120 °C.

Polyimide (Vespel®)

This material is wear-resistant and permanent resilient thermally (up to 200 °C) as well as mechanically. It is chemically broadly inert (pH range 1-10) and is especially resistant against acidic to neutral and organic solvents, but vulnerable to pH strong chemical or oxidizing environments: It is incompatible with concentrated mineral acids (such as sulfuric acid), glacial acetic acid, DMSO and THF. In addition, it will be disintegrated by nucleophilic substances like ammonia (such as ammonium salts under alkaline conditions) or acetate.

Ethylene-tetrafluorethylene copolymer (ETFC, Tefzel®)

This fluorinated polymer is highly resistant against neutral and alkaline solvents. Some chlorinated chemicals in connection with this material should be handled with care. Maximum operating Temperature is 80 °C.

Perfluorethylenpropylen-Copolymer (FEP), Perfluoralkoxy-Polymer (PFA)

These fluorinated polymers hold similar features as PTFE, but with a lower operation temperature (up to 205 °C). PFA is suitable for ultrapure applications, FEP can be used universally. They are resistant against almost all organic and inorganic chemicals, except elemental fluorine under pressure or at high temperatures and fluorine-halogen compounds.

Polyoxymethylene (POM, POM-H-TF)

POM is a semi-crystalline, high-molecular thermoplastic material which stands out due to its high stiffness, low friction value and thermic stability. It can even substitute metal in many cases. POM-H-TF is a combination of PTFE fibres and acetal resin and is softer and has better slip properties as POM. The material is resistant against diluted acids (pH > 4) as well as diluted lyes, aliphatic, aromatic and halogenated hydrocarbons, oils and alcohols. It is not compatible with concentrated acids, hydrofluoric acid and oxidizing agent. Maximum operating Temperature is 100 °C.

Polyphenylene sulfide (PPS)

PPS is a soft polymer which is known for its high break resistance and very high chemical compatibility. It can be used with most organic, pH neutral to pH high, and aqueous solvents at room temperature without concerns. However, it is not recommended for using with chlorinated, oxidizing and reducing solvents, inorganic acids or at higher temperatures. Maximum operating temperature: 50 °C.

Polytetrafluorethylene (PTFE, Teflon®)

PTFE is very soft and anti-adhesive. This material is resistant against almost all acids, lyes and solvents, except against fluid sodium and fluoride compounds. In addition, it is temperature-resistant from -200 °C to +260 °C.

Systec AF™

This amorphous perfluorinated copolymer is inert against all commonly used solvents. However, it is soluble in perfluorinated solvents like Fluorinert® FC-75 and FC-40, and Fomblin perfluor-polyether solvents from Ausimont. In addition, it is affected by Freon® solvents.

Polychlorotrifluoroethylene (PCTFE, Kel-F®)

The semi-crystalline thermoplastic material is plasticizer-free and dimensionally stable, even in a wide temperature range (-240 °C to +205 °C). It is moderately resistant against ether, halogenated solvents and toluene. Halogenated solvents over +60 °C and chlorine gas should not be used.

Fluorinated rubber (FKM)

The elastomer consisting of fluorinated hydrocarbon stands out due to a high resistance against mineral oils, synthetic hydraulic fluids, fuels, aromatics, and many organic solvents and chemicals. However, it is not compatible with strong alkaline solvents (pH value >13) like ammonia, and acidic solvents (pH value <1), pyrrole and THF. Operating temperature: Between -40 °C and +200 °C.

Perfluorinated rubber (FFKM)

This perfluoro elastomer has a higher fluorine content as fluorinated rubber and is therefore chemically more resistant. It can be employed at higher temperatures (up to 275 °C). It is not compatible with Pyrrole.

12.3 Non-metals

Diamond-like carbon (DLC)

This material is characterized by a high hardness, a low coefficient of friction and thus low wear. In addition, it is highly biocompatible. DLC is inert against all acids, alkalis and solvents commonly used in HPLC.

Ceramic

Ceramic is resistant against corrosion and wear and is fully biocompatible. An incompatibility against acids, alkalis and solvents commonly used in HPLC is not known.

Alumina (Al₂O₃)

Due to their high resistance to wear and corrosion, alumina ceramic is used as a coating for mechanically stressed surfaces. It is a biocompatible material with low thermal conductivity and low thermal expansion.

Zirconium oxide (ZrO₂)

Zirconia ceramics are characterized by their high mechanical resistance, which makes them particularly resistant to wear and corrosion. It is also biocompatible, has low thermal conductivity and is resistant to high pressures.

Sapphire

Synthetic sapphire is virtually pure monocrystalline alumina. It is biocompatible and very resistant to corrosion and wear. The material is characterized by a high hardness and a high thermal conductivity.

Ruby

Synthetic ruby is monocrystalline alumina and gets its red color by the addition of some chromium oxide. It is biocompatible and very resistant to corrosion and wear. The material is characterized by a high hardness and a high thermal conductivity.

Mineral wool

This insulating material consists of glass or stone wool fibres and isolates in high oxidizing conditions and at high temperatures. Mineral wool is valid as commonly inert against organic solvents and acids.

Glass, glass fibre, quartz, quartz glass

These mineral materials are resistant against corrosion and wear and are mostly chemical inert. They are compatible with oils, fats and solvents and show a high resistance against acids and lyes up to pH values of 3-9. Concentrated acids (especially hydrofluoric acid) may embrittle and corrode the minerals. Lyes may ablate the surfaces slowly.

12.4 Metals

Stainless steel

Stainless steel is, apart from PEEK, the standard material in HPLC. Steels with WNr. 1.4404 (316L) are used, or with a mixture of higher compatibility.

They are inert against almost all solvents. Exceptions are biological applications which are metal ion sensitive, and applications with extreme corrosive conditions. These steels, in comparison to commonly used steels, are increasingly resistant against hydrochloric acid, cyanides and other halogen acids, chlorides and chlorinated solvents.

The use in ion chromatography is not recommended. In case of electrochemical applications, a passivation must be executed first.

Hastelloy®-C

This nickel-chrome-molybdenum alloy is extremely resistant to corrosion, especially against oxidizing, reducing and mixed solvents, even at high temperatures. This alloy may be used in combination with chlor, formic acid, acetic acid and saline solutions.

Titanium, titanium alloy (TiA16V4)

Titanium has a low weight and a high hardness and stability. It stands out due to its very high chemical compatibility and biocompatibility. Titan is applied when neither stainless steel nor PEEK are usable.

13. Repeat orders

13.1 Devices

Article	Order no.
Basic device with stainless steel pressure sensor, without pump head, with accessories	APC40
Basic device with metal-free pressure sensor, without pump head, with accessories	APC60
Pump with 10 ml pump head, stainless steel, with accessories	APC40EA
Pump with 10 ml pump head, ceramic, with accessories	APC60EB
Pump with 10 ml pump head, stainless steel for high temperature applications, with accessories	APC40EE
Pump with 10 ml pump head, stainless steel, for high temperature applications, with back piston flushing, with accessories	APC40EI
Pump with 50 ml pump head, stainless steel, with accessories	APC40FA
Pump with 50 ml pump head, ceramic, with accessories	APC60FB
Pump with 50 ml pump head, stainless steel, for high temperature applications with accessories	APC40FE
Pump with 50 ml pump head, stainless steel, for high temperature applications, with back piston flushing, with accessories	APC40FH

13.2 Spare parts

Article	Order no.
10 ml pump head, stainless steel, accessories	AHB40
10 ml pump head, stainless steel, for normal phase applications, accessories	AHB40BA
10 ml pump head, stainless steel, for water applications, accessories	AHB40FA
10 ml pump head, ceramic, accessories	AHB32
10 ml pump head, stainless steel, for high temperature applications	AHB40CA
10 ml pump head, stainless steel, for high temperature applications, with back piston flushing	AHB40CB
10 ml pump head, ceramic, for water, accessories	AHB32GA
10 ml pump head, stainless steel, titanium fittings, accessories	AHB32DA

Article	Order no.
50 ml pump head, stainless steel, accessories	AHC20
50 ml pump head, stainless steel, for normal phase applications, accessories	AHC20BA
50 ml pump head, stainless steel, for water applications	AHC20FA
50 ml pump head, stainless steel for high temperature applications	AHC20CA
50 ml pump head, stainless steel, for high temperature applications, with back piston flushing	AHC20CB
50 ml pump head, ceramic, with accessories	AHC22
50 ml pump head, ceramic, for water applications, with accessories	AHC22FA
Check valve for 10 ml and 50 ml pump head, for dosing applications	A06840
Check valve for 10 ml pump head for HPLC applications	A06841
Check valve (spring supported) for 10 ml and 50 ml pump head	A068411
Check valve for 50 ml pump head	A06842
Network cable	A5255
Set of connector strips: 2 x connector strip, 12-pin, male	A1420V12
2 x ribbon cable (1.5 m, 10-pin)	A1467
RS-232 connection cable	A0895
Accessory kit 40P	FPC30
Accessory kit 10 ml pump head, stainless steel	FHB40
Accessory kit 10 ml pump head, ceramic	FHB32
Accessory kit 50 ml pump head, stainless steel	FHC20
Accessory kit 50 ml pump head, ceramic	FHC22

Installation Qualification (IQ) for a Device

	Created	Reviewed	Approved
Function			
Name			
Date			
Signature			

0. Customer pre-approval

Prior to installation at the customer site, the customer has reviewed the IQ document and agrees with the design and scope.

Company name:

Name	Function	Reviewed & approved	Date	Signature

Installation Qualification (IQ) for a Device

1. Definition of the Installation Qualification

The qualification document "Installation Qualification (IQ)" is part of the quality management system at the company KNAUER Wissenschaftliche Geräte GmbH.

2. Scope

The customer can request the Installation Qualification. In case of a request, the technical support of KNAUER or a provider authorized by KNAUER performs this functionality test during the installation. The IQ is a standardized document and includes the following:

- Confirmation of flawless condition at delivery
- Check if the delivery is complete
- Certification on the functionality of the device

3. Instructions

All deviations from the specifications that occurred during installation have to be recorded in this document.

In addition, all measures taken to eliminate the deviations have to be noted down as comments in the list of rectifications (LOR) on page 4.

If certain items in the report are not applicable, this has to be indicated in the table as "N/A" (not applicable). Major sections that are not used have to be crossed out (diagonal line), marked "N/A", dated and signed.

All required documents have to be completed by the end of the installation. The document has to be reviewed and approved by an authorized person. The review and approval have to be documented with signature and date (DD/MM/YYYY).

The tests have to be carried out in a suitable environment, as described in the user instruction of the device.

4. About this document

The information in this document is subject to change without prior notice. This document may not be used, reproduced or translated without written consent of KNAUER Wissenschaftliche Geräte GmbH. Depending on the customer's quality assurance system, the signed document either has to be filed in the device folder or scanned and stored in an electronic archive.

5. Device data

Device name		Product number	
Serial number		Order number	
Firmware version			
Installation location			

6. Customer and manufacturer data

	Customer	Manufacturer
Company		KNAUER Wissenschaftliche Geräte GmbH
Customer number		-
Contact person/agent		
Address		Hegauer Weg 38
Postal Code/City		14163 Berlin
Phone		+49 30 80 97 27 111
E-Mail		support@knauer.net

Installation Qualification (IQ) for a Device

7. Installation Qualification Tests

Test	Description	Specification	Passed	Failed	N/A	Comment/LOR No.
1	Identify the device.	The name on the device matches the name on the delivery order.				
2	Check the device for transport damage.	No transport damage is observed.				
3	Check the scope of delivery.	The scope of delivery matches the packing list and/or the delivery order.				
4	Check that the technical documentation provided is correct and complete (material documentation of wetted parts, calibration certificates etc.).	The documentation is correct and complete.				
5	Check that all equipment is properly and correctly labeled according to the delivery order and/or the labeling specifications document, if applicable.	The equipment is labeled correctly.				
6	Connect all loose parts (e.g. capillaries, tubings, measuring head) according to the user instructions.	The device is fully assembled and ready to use.				
7	Ensure that the installation site is suitable according to the user instructions.	The installation site matches the specifications in the user instructions.				
8	Connect the device to the power supply and switch it on.	The device starts (operating noise). The power LED or the display lights up.				

Installation Qualification (IQ) for a Device

9. List of changes to the document

Revision no.	Description of change	Additional information	Date/signature

Installation Qualification (IQ) for a Device

10. Certificate and approval

A KNAUER employee or an employee authorized by KNAUER has checked the device and performed all tests described in the IQ.

The IQ form has to be signed by an authorized person. The scope of the IQ meets the customer's requirements.

The results of the IQ, any changes made as well as the IQ process have been documented in this form in writing. The users listed below were instructed and are familiar with how to operate the device. Both parties confirm that the IQ has been performed to the customer's satisfaction by signing it.

10.1 Customer approval

Name	Function	Date	Signature

10.2 KNAUER agent approval

Name	Function	Date	Signature

11. Comments / recommendations

Science with Passion



Latest KNAUER instructions online:
www.knauer.net/library

KNAUER
Wissenschaftliche Geräte GmbH
Hegauer Weg 38
14163 Berlin

Phone: +49 30 809727-0
Fax: +49 30 8015010
E-Mail: info@knauer.net
Internet: www.knauer.net