

Foxy[®] R1 and Foxy[®] R2



Foxy R1

Foxy R2



Part #69-2133-667
Copyright © 2008. All rights reserved, Teledyne Isco
Revision K: April 2020

Foreword

This instruction manual is designed to help you gain a thorough understanding of the operation of the equipment. Teledyne Isco recommends that you read this manual completely before placing the equipment in service.

Although Teledyne Isco designs reliability into all equipment, there is always the possibility of a malfunction. This manual may help in diagnosing and repairing the malfunction.

If a problem persists, call or e-mail Teledyne Isco technical support for assistance. Simple difficulties can often be diagnosed over the phone. For faster service, please have your serial number ready.

If it is necessary to return the equipment to the factory for service, please follow the shipping instructions provided by technical support, including the use of the **Return Material Authorization (RMA)** specified. **Be sure to include a note describing the malfunction.** This will aid in the prompt repair and return of the equipment.

Teledyne Isco is continually improving its products and reserves the right to change product specifications, replacement parts, schematics, and instructions without notice.

Contact Information

Customer Service

Phone: (800) 228-4373 (USA, Canada, Mexico)
(402) 464-0231 (Outside North America)
Fax: (402) 465-3022
Email: IscoCSR@teledyne.com

Technical Support

Phone: Toll Free (800) 775-2965 (Syringe Pumps and Liquid Chromatography)
Email: IscoService@teledyne.com
Return equipment to: 4700 Superior Street, Lincoln, NE 68504-1398

Other Correspondence

Mail to: P.O. Box 82531, Lincoln, NE 68501-2531
Email: IscoInfo@teledyne.com

Foxy[®] R1 and Foxy[®] R2 Fraction Collectors

Table of Contents

Section 1 Introduction

1.1 Collection Schemes	1-2
1.2 Racks and Vessels	1-3
1.3 Features	1-4
1.4 Technical Specifications	1-6
1.5 Rear Panel Connectors	1-8
1.6 Accessory Cable Specifications	1-10
1.6.1 Cables for Isco Accessories	1-10
1.6.2 Cable for non-Isco Pumps	1-10
1.6.3 Cable for non-Isco Detectors	1-11

Section 2 Preparation for Use

2.1 Preliminary Checkout	2-1
2.2 Fluid Connections	2-5
2.2.1 Standard Diverter Valve Connections	2-5
2.2.2 High Flow Diverter Valve Connections	2-7
2.2.3 Drip Tray Drain Connection	2-9
2.3 Rack Installation	2-10
2.4 Diverter Valve Adjustment	2-12
2.5 Installation Qualification Checklist	2-13

Section 3 Programming

3.1 Main Menu	3-2
3.2 Configuration Settings	3-3
3.2.1 Rack Settings	3-3
3.2.2 RS-232 Serial Settings	3-5
3.2.3 TCP/IP Settings	3-6
3.2.4 Inject Options	3-6
3.2.5 Pump Control Settings	3-9
3.2.6 Analog Peak Settings	3-9
3.2.7 Fraction Collector Information	3-9
3.3 Method Settings	3-10
3.3.1 Method Selection	3-10
3.3.2 Drop Counts	3-11
3.3.3 Time Intervals	3-13
3.3.4 Volume	3-14
3.3.5 Threshold Detection	3-15
3.3.6 Peak Width Detection	3-17
3.3.7 Time Windows	3-20

Section 4 Serial Command Control

4.1 Introduction	4-1
4.2 RS-232 Communication Information	4-1
4.3 Ethernet Communication Information	4-1

4.4	General Command Information	4-1
4.4.1	Character Format	4-1
4.4.2	Command Syntax	4-2
4.4.3	Line Syntax	4-2
4.4.4	Modes	4-2
4.4.5	Errors	4-2
4.4.6	Timing	4-2
4.5	Serial Commands	4-2
4.5.1	Miscellaneous Commands	4-2
4.5.2	Immediate Control Commands	4-6
4.5.3	Programming Commands	4-9
4.5.4	Problem Responses	4-17

Section 5 Maintenance

5.1	Introduction	5-1
5.2	Maintenance	5-1
5.2.1	Tubing Inspection	5-1
5.2.2	Collection Rack and Drip Tray Cleaning	5-2
5.2.3	Exterior Cleaning	5-2
5.2.4	Fluid Path Cleaning	5-2
5.2.5	Drop Counter Cleaning	5-3
5.3	Service	5-4
5.4	Instrument Returns	5-4
5.4.1	How to Ship Returns	5-4

Appendix A Icon Glossary and Menu Charts

A.1	Touch Screen Icon Glossary	A-1
A.2	Touch Screen Menu Flow Charts.	A-6

Appendix B Replacement Parts Listings

List of Figures

1-1	Foxy R1 and Foxy R2 fraction collectors	1-1
1-2	Fraction collector features	1-5
2-1	Adjusting the height of the standard and high flow diverter valves	2-2
2-2	Main menu	2-3
2-3	Method Select screen	2-3
2-4	Edit Method Settings screen	2-4
2-5	Time-based Fractions screen	2-4
2-6	Diverter valve ports	2-5
2-7	Tubing preparation	2-6
2-8	Connections to standard diverter valve	2-7
2-9	High flow diverter valve ports (front view)	2-8
2-10	Tubing preparation, high flow	2-8
2-11	Connections to high flow diverter valve	2-9
2-12	Rack guide pins and bottle location ridges	2-11
2-13	Rack installed with ground post touching guide pin	2-11
2-14	Diverter Valve adjusted with 1/2 inch or 1 cm clearance.	2-12
3-1	Main Menu	3-2
3-2	Configuration Tools Menu	3-3
3-3	Rack options menu	3-3
3-4	Inject options timing diagram	3-7
3-5	Timed options timing diagram	3-7
3-6	Overlay, Next and Skip options diagram	3-8
3-7	Method Settings Menu	3-10
3-8	Method Selection Menu	3-10
3-9	Rename Method display	3-11
3-10	Drop Counts display	3-11
3-11	Time Intervals display	3-13
3-12	Volume display	3-14
3-13	Threshold detection.	3-15
3-14	Threshold Settings menu	3-16
3-15	Peak Width detection	3-17
3-16	Peak Width Settings menu	3-18
3-17	Time Windows limit the collection to specific time durations	3-20
3-18	Time Windows Settings menu	3-21
5-1	Retaining ring for the drop counter's glass sleeve	5-3
A-1	Configuration settings	A-6
A-2	Configuration settings, continued	A-7
A-3	Programming displays for the current method	A-8
A-4	Saved method recall and method name editing	A-9

List of Tables

1-3 Rear Panel Connectors	1-8
1-4 Ethernet Connector Pins	1-8
1-5 Pump Connector Pins	1-9
1-6 Detector Connector Pins	1-9
1-7 RS-232 Serial Communication Connector Pins	1-10
1-8 Non-Isco Pump Cable, P/N 69-2134-170	1-11
1-9 Non-Isco Detector Cable, P/N 69-2134-171	1-11
5-1 Installation Qualification Checklist	2-13
A-1 Touch screen display icons	A-1

General Warnings

Before installing, operating, or maintaining this equipment, it is imperative that all hazards and preventive measures are fully understood. While specific hazards may vary according to location and application, take heed of the following general warnings:

 **WARNING**

Liquids associated with this instrument may be classified as carcinogenic, biohazard, flammable, or radioactive. Should these liquids be used, it is highly recommended that this application be accomplished in an isolated environment designed for these types of materials in accordance with federal, state, and local regulatory laws, and in compliance with your company's chemical/hygiene plan in the event of a spill.

 **WARNING**

Avoid hazardous practices! If you use this instrument in any way not specified in this manual, the protection provided by the instrument may be impaired.

 **WARNING**

If this system uses flammable organic solvents, Teledyne Isco recommends that you place this system in a well-ventilated environment, designed for these types of materials. This environment should be constructed in accordance with federal, state, and local regulations. It should also comply with your organization's plan concerning chemical and hygiene mishaps. In all cases use good laboratory practices and standard safety procedures.

 **WARNING**

For indoor use only.

 **WARNING**

If you are using flammable solvents or chemicals with this system, vapor concentration levels may exceed the maximum exposure levels as recommended by OSHA Guide 1910.1000. To reduce those levels to a safe exposure, Teledyne Isco recommends that you place the system in a laboratory hood designed for the purpose of ventilation. This hood should be constructed and operated in accordance with federal state and local regulations. In the event of a solvent or chemical spill, your organization should have a plan to deal with these mishaps. In all cases, use good laboratory practices and standard safety procedures.

Hazard Severity Levels

This manual applies *Hazard Severity Levels* to the safety alerts, These three levels are described in the sample alerts below.

 **CAUTION**

Cautions identify a potential hazard, which if not avoided, may result in minor or moderate injury. This category can also warn you of unsafe practices, or conditions that may cause property damage.

 **WARNING**









Warnings identify a potentially hazardous condition, which if not avoided, could result in death or serious injury.

 **DANGER**

DANGER – limited to the most extreme situations to identify an imminent hazard, which if not avoided, will result in death or serious injury.

Hazard Symbols

The equipment and this manual use symbols used to warn of hazards. The symbols are explained below.

Hazard Symbols	
Warnings and Cautions	
	The exclamation point within the triangle is a warning sign alerting you of important instructions in the instrument's technical reference manual.
	The lightning flash and arrowhead within the triangle is a warning sign alerting you of "dangerous voltage" inside the product.
Symboles de sécurité	
	Ce symbole signale l'existence d'instructions importantes relatives au produit dans ce manuel.
	Ce symbole signale la présence d'un danger d'électocution.
Warnungen und Vorsichtshinweise	
	Das Ausrufezeichen in Dreieck ist ein Warnzeichen, das Sie darauf aufmerksam macht, daß wichtige Anleitungen zu diesem Handbuch gehören.
	Der gepfeilte Blitz im Dreieck ist ein Warnzeichen, das Sie vor "gefährlichen Spannungen" im Inneren des Produkts warnt.
Advertencias y Precauciones	
	Esta señal le advierte sobre la importancia de las instrucciones del manual que acompañan a este producto.
	Esta señal alerta sobre la presencia de alto voltaje en el interior del producto.

Foxy[®] R1 and Foxy[®] R2 Fraction Collectors

Section 1 Introduction

The Foxy R1 and R2 fraction collectors are liquid distribution instruments for indoor laboratory applications. The fraction collectors have the ability to divide the liquid into multiple collection vessels, switching vessels on time, drops, volume, peaks, or a combination of these parameters. Collection vessels can be test tubes, vials, mini-wells, bottles, and funnels. The symbolic touch screen display simplifies set up for a variety of collection routines.



Figure 1-1 Foxy R1 (left) and Foxy R2 (right) fraction collectors

1.1 Collection Schemes

The fraction collector supports several types of collection schemes. Basic collection schemes collect uniform volumes (fractionation). These uniform modes for tube advances include:

Drop Counting – The fraction collector counts the drops from the drop former. When the count reaches a user-specified number of drops, the fraction collector advances to the next tube. The fraction collector can count up to 999 drops per fraction. Drop counting is not available on the Foxy R2 High Flow fraction collector.

Time Intervals – The fraction collector can advance to the next tube at fixed time intervals. Tube changes can occur as rapidly as every second, or wait up to 99:59:59 (HH:MM:SS).

Volume Intervals – The fraction collector can switch tubes at fixed volume intervals. This collection mode requires an input signal from a pump that correlates its delivery volume. This signal can represent actual volumetric units, or more typically, a pump revolution counter. The fraction collector can count up to 999 units.

The fraction collector can perform additional tube advances based on a variable input signal. The fraction collector reads this input signal from an external device to isolate peak fluids from non-peak fluids. Typically the input signal represents UV light absorbing compounds in chromatographic eluate. Signals may also represent other measurable liquid properties such as visible light absorbance, fluorescence, pH, or any parameter with an analog output signal. Tube advances at the leading and lagging edges of the peak isolate peak fluids from non-peak fluids, commonly called “peak cutting.”

These peak collection modes are:

Threshold Peak Detection – The fraction collector can perform a tube advance whenever the monitored signal passes a user-specified threshold. The threshold, set as a percentage of the input signal, typically is set high enough to eliminate false peaks due to a noisy signal baseline.

Peak Width Detection – The fraction collector can perform a tube advance when the rising or falling slope of the input signal indicates the leading or lagging edge of a peak. The user-selected peak width setting is part of a peak detection algorithm which differentiates true peaks from false indications such as noise and shifting baselines. With the correct peak width setting, this collection mode can cut closely eluting and even overlapping peaks.

Threshold and peak width detection may be combined together. Additionally, whether one or both peak detections modes are used, the fraction collector always combines peak detection with a uniform mode so that it does not exceed the tube capacity while a peak is active.

The fraction collector can also limit the fraction collection to certain time durations during a collection routine. The Time Windows collection scheme is described below.

Time Window – The fraction collector can collect fluids within time windows. This collection mode allows the user to collect or reject fluids based on time. For example, the time window can start one minute into the run to divert initial waste fluids, and then end ten minutes into the run to reject any late eluting peaks that might occur during a five minute column flush. In other words, fractions will only be collected for the nine minutes of the run which deliver fractions of interest.

Up to four time windows may be combined with a uniform collection mode and with peak detection.

1.2 Racks and Vessels

The fraction collector is designed to accept a variety of racks. The racks align the collection tubes, minivials, and mini-well plates under the drop former, and allow for quick removal and replacement. The factory ships the Foxy R1 fraction collector with one rack; the Foxy R2 fraction collector ships with two.

The following racks are available:

60-2137-150	One rack for 13 mm diameter tubes. Holds 144 tubes.
60-2137-151	One rack for 16 mm diameter tubes. Holds 100 tubes.
60-2137-152	One rack for 18 mm diameter tubes. Holds 72 tubes.
60-2137-153	One rack for 25 mm diameter tubes. Holds 36 tubes.
60-2137-156	One rack for 28 mm diameter scintillation vials. Holds 36 vials.
60-2137-154	One rack for 1.5 mL microcentrifuge tubes. Holds 60 tubes.
60-2137-157	One rack for 50 mL centrifuge tubes. Holds 36 tubes.
60-2137-159	One rack for 96-well microplates. Holds 2 microplates for a total of 192 wells.
60-5247-004	Foxy R2 Only - Set of two racks for 480 mL glass bottles. Each rack holds nine bottles for a total of 18.
60-2137-062	Case of 40 glass 480 mL bottles for 60-5247-004 on the Foxy R2. On the Foxy R1, nine of these bottles may be placed directly on the drip tray—no rack is required.

These racks are chemically resistant, made from stainless steel and polypropylene. The racks accept standard-sized, user-supplied tubes, vials, and microplates of any material. When in place, these racks are electrically grounded. This safety feature dissipates electrostatic charges when collecting organic solvents at high flow rates.

For nearly unlimited collection vessel capacities, the factory offers funnel racks. These funnel racks direct the fluids to containers of any size below the fraction collector. The construction materials are listed with each type.

60-2137-162	Foxy Preparative Rack with 26 ETFE or ECTFE funnels and 50 ft. of 3/8 inch FEP-lined tubing. (For Foxy R2 only. Occupies both rack positions.)
60-2137-163	Foxy Preparative Rack with 36 ETFE or ECTFE funnels and 50 ft. of 1/4 inch ID of vinyl tubing. Takes up one rack position. Fits both the Foxy R1 and R2.

 **Note**

All racks and funnels include RFID tags for automatic detection by the Foxy R2 fraction collector.

1.3 Features

Figure 1-2 and Table 1-1 identify key features on the Foxy R1 and Foxy R2 fraction collectors.

Table 1-1 Fraction collector features

1	The touch screen LCD displays icons for turning the fraction collector ON or to Standby, configuring basic settings, and programming the unit for operation.
2	Under program control, the diverter valve assembly either deposits fluids into the vessel or out to a user-supplied waste container. The standard diverter valve assembly includes the drop former/counter.
3	The height adjustment knob allows the user to set drop former/counter outlet at safe yet minimal distance above the collection tubes or funnels.
4	The fraction collector arm moves along the Y-axis to position the arm over the correct row. The arm includes electromechanical components move the diverter valve along the X-axis to position the drop former/counter over the collection vessel.
5	The drip tray catches fluid when the collection rack is mis-configured in the software, when collection tubes are missing, and when collection tubes are over-filled.
6	The rack guide pins ensure the racks and funnels are correctly positioned under the diverter valve assembly. Some guide pins also serve as an electrical ground to dissipate static electricity that can build up when collecting organic solvents at high flow rates.
7	The adjustable foot allows you to level the fraction collector.
8	The drip tray drain can route overflow fluids to a user-supplied collection container or drain.
9	A secondary drain routes any fluids that miss the drip tray to a common collection point.

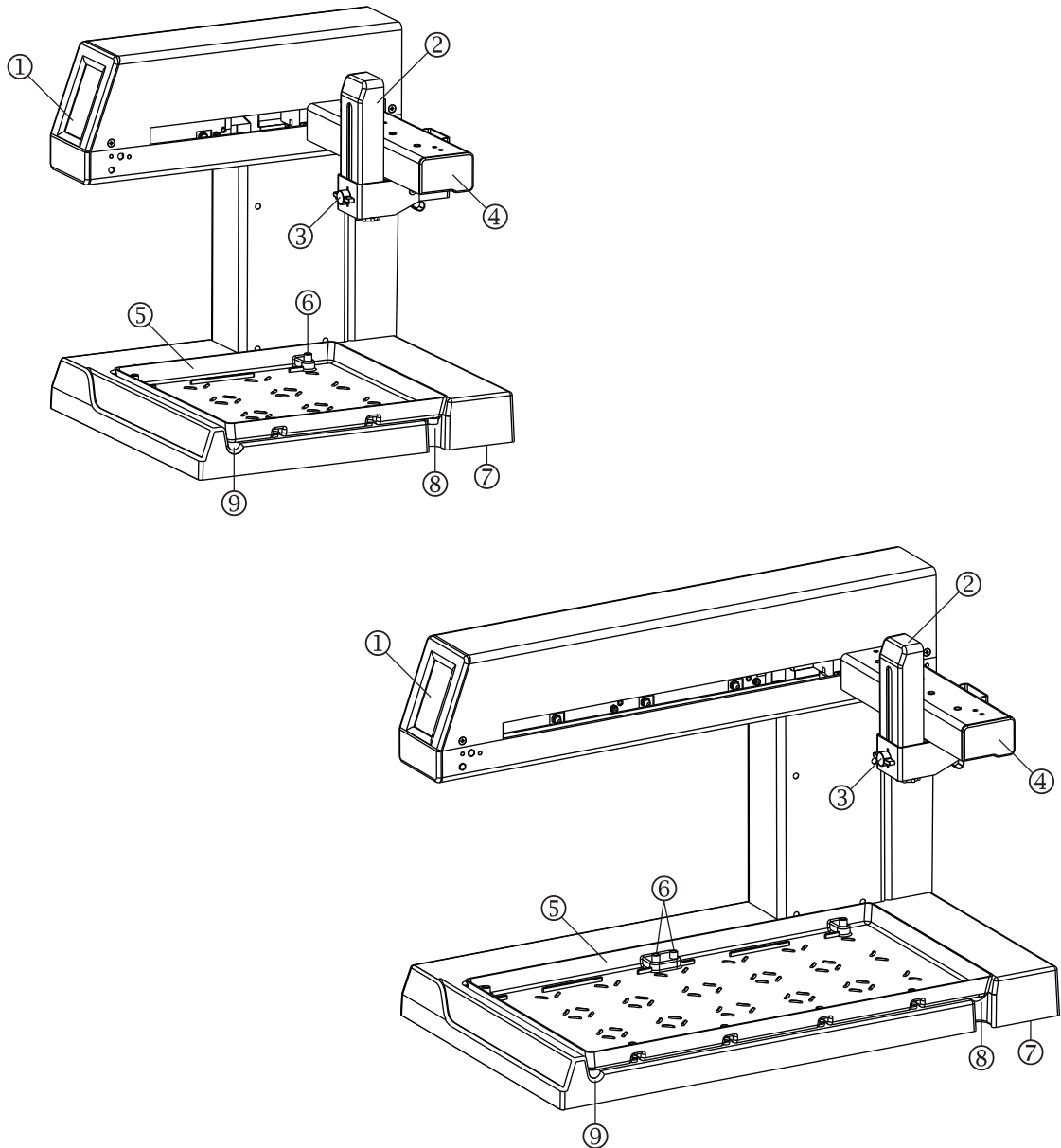

Figure 1-2 Fraction collector features

1.4 Technical Specifications

Table 1-2 lists the fraction collector technical specifications.

Table 1-2 Specifications^a

Dimensions: (width, depth, height)	Foxy R1 (PN 68-3870-010): 12.25, 13.0, 14.0 in. (31.1, 33.0, 35.5 cm) Foxy R2 (PN 68-2130-006): 12.25, 21.0, 14.9 in. (31.1, 53.3, 37.8 cm) Foxy R2 High Flow (PN 68-2130-007): 12.25, 21.0, 15.5 in. (31.1, 53.3, 39.4 cm)
Weight: (with drip tray, no tube rack)	Foxy R1: 15.6 lbs. (7.1 kg) Foxy R2: 22.8 lbs. (10.3 kg) Foxy R2 High Flow: 22.9 lbs. (10.4 kg)
Available Racks:	13 mm diameter tubes (144/rack) 16 mm diameter tubes (100/rack) 18 mm diameter tubes (72/rack) 25 mm diameter tubes (36/rack) 1.5 mL microcentrifuge tubes (60/rack) 50 mL centrifuge tubes (36/rack) 28 mm diameter scintillation vials (36/rack) 96-well microplates (R1 rack holds 2 plates; R2 rack holds 6 plates) 480 mL bottles ^b Funnel racks for fractions larger than 480 mL
Maximum Tube Height:	Foxy R1: 160 mm Foxy R2: 196 mm Foxy R2 High Flow: 180 mm
Maximum Flow Rate:	Foxy R1 (68-3870-012): Standard flow rate of 25 mL/min (through ¹ / ₁₆ inch I.D. tubing). Optional accessory package 60-2139-032 extends maximum flow rate to 125 mL/min (through ¹ / ₈ inch I.D. tubing). Foxy R2 (68-2130-007): Standard maximum flow rate of 125 mL/min (through ¹ / ₈ inch I.D. tubing). Optional accessory package 60-2139-031 reduces flow rate to 25 mL/min (through ¹ / ₁₆ inch I.D. tubing). Foxy R2 with high flow diverter valve (68-2130-007): 1000 mL/min
Delay Volume:	Drop former located beneath diverter valve for µL delay volume. Compensation only required for length of tubing to the diverter valve.

Table 1-2 Specifications^a (Continued)

Standard Diverter Valve Internal Volume:	Drop former (NC): 110 µL Waste (NO): 130 µL
Diverter Valve Inlet Pressure:	25 psi (1.723 bar) maximum, standard and high flow valves
Peak Detection:	Threshold level, peak width (slope detection), time windows
System Control:	Operator: Front panel control via touch screen LCD Integrated systems: Direct communication via Ethernet (TCP/IP) and RS-232 serial communications.
Stored Methods:	Eight
Operating Voltage:	100–240 VAC, 50–60 Hz, 1 ampere maximum. Mains voltage must not exceed 10% of the nominal supply voltage.
Operating Temperature:	0 to 40 °C 32 to 104 °F
Humidity:	95% relative humidity maximum. Internal heaters protect internal components.
Inputs:	Pump counter ^c , external peak ^c , inject ^c , tube advance ^c , analog peak voltage ^d .
Outputs:	Pump pause ^e , tube change event ^f .
Wetted Materials:	Valve: PEEK and Perfluoroelastomer (FFKM) Supplied ferrules: ETFE Supplied valve tubing: PTFE Supplied drain tubing: Vinyl
Typical Applications:	Prep-HPLC, peptide/protein purification, soil extraction, density gradient fractionation.
Electrical Safety per EN 61010-1, Second Edition:	
Maximum Altitude:	2000 meters
Pollution Degree:	2
Installation Category	II

- a. Teledyne Isco is continually improving its products therefore specifications are subject to change.
- b. No rack is required for R1 which holds 9 bottles on the drip tray. R2 requires a set of two racks which hold a total of 18 bottles.
- c. +3.3 to 5 VDC or contact closure, active low, 30 ms minimum, 5 VDC max.
- d. 0 to 1.0 V nominal, –1.2 to +1.2 V usable, –5 to +5 V max.
- e. Output is open collector, active low, 15 VDC/100 mA maximum
- f. 300 millisecond output is open collector, active low, 15 VDC/100 mA maximum.

1.5 Rear Panel Connectors The rear panel connectors are used to power the fraction collector and connect it to other devices.

Table 1-3 Rear Panel Connectors

Connectors	Item Number	Description
	1	Ethernet 1 Connector (See Table 1-4)
	2	Ethernet 2 Connector (Table 1-4)
	3	Pump Connector (Table 1-5)
	4	Detector Connector (Table 1-6)
	5	RS-232 Serial Connector (Table 1-7)
	6	AC Mains Power Mains power must meet the voltage, frequency, and amperage requirements listed on the serial number label. Mains power fluctuations must not exceed 10% of the nominal supply voltage. The mains power cord is the disconnect device.

Table 1-4 Ethernet Connector Pins

Connector	Pin	Type	Description
	1	Output/Input	TX+ / RX+ (auto MDI/MDIX)
	2	Output/Input	TX- / RX- (auto MDI/MDIX)
	3	Input/Output	RX+ / TX+ (auto MDI/MDIX)
	4	Termination	
	5	Termination	
	6	Input/Output	RX- / TX- (auto MDI/MDIX)
	7	Termination	
	8	Termination	

Table 1-5 Pump Connector Pins

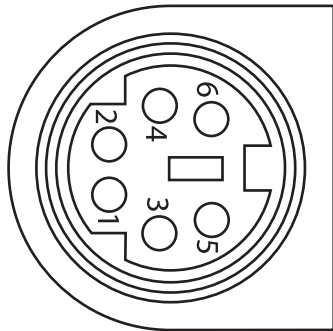
Connector	Pin	Type	Description
	1	Input	Count: pump volume signal ^a
	2	Output	Pump pause: stops pump between tubes and at end of run ^b
	3	Output	Valve output: control signal for optional high flow diverter valve
	4	Common	Circuit common
	5	Output	+24 VDC Output: power for optional high flow diverter valve
	6	Not used	
	K	Shield	Earth ground

- a. Input is +3.3 to 5 VDC or contact closure, active low, 30 ms minimum, 5 VDC maximum.
- b. Output is open collector, active low, 15 VDC/100 mA maximum

Table 1-6 Detector Connector Pins

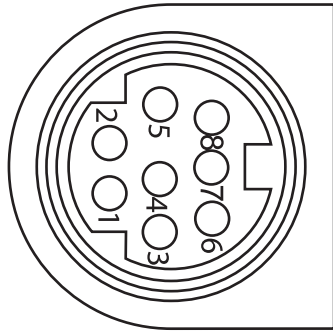
Connector	Pin	Type	Description
	1	Common	Analog common for use with pin 8
	2	Input	Ext peak ^a
	3	Not used	
	4	Output	Event: pulse delivered at tube change ^b
	5	Input	Inject: starts an inject cycle ^a
	6	Input	Tube Advance ^{1a}
	7	Common	Circuit common
	8	Input	Analog detector signal: used for peak detection ^c
K	Shield	Earth ground	

- a. Input is +3.3 to 5 VDC or contact closure, active low, 30 ms minimum, 5 VDC maximum.
- b. 300 millisecond output is open collector, active low, 15 VDC/100 mA maximum.
- c. Analog input is 0 to 1.0 V nominal, -1.2 to +1.2 V usable, -5.0 to +5.0 V maximum.

Table 1-7 RS-232 Serial Communication Connector Pins

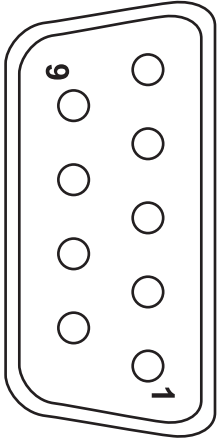
Connector	Pin	Type	Description
	1	Not used	
	2	Output	TxD RS-232 serial data out
	3	Input	RxD RS-232 serial data in
	4	Reserved	
	5	Common	Circuit common
	6	Reserved	
	7	Not used	
	8	Not used	
	9	Not used	
	K	Shield	Earth Ground

1.6 Accessory Cable Specifications

1.6.1 Cables for Isco Accessories

Cables are available to connect the fraction collector to Isco equipment:

- To connect the fraction collector to a TRIS pump, order accessory cable 69-2134-172. This cable connects the Signal output from the TRIS pump to the fraction collector's Pump connection. This cable carries the pump count and pump pause signals.
- To connect the fraction collector to an Isco UV-Vis detector such as the UA-6, order accessory cable 69-2134-173. This cable carries the analog peak detector signal, as well as the tube advance, event pulse, external peak, and inject signals.

1.6.2 Cable for non-Isco Pumps

A cable is available to connect the fraction collector to a non-Isco pump. Part number 69-2134-170 is a six-foot long cable with one end terminated as a 6-pin mini-DIN connector. The other end is stripped and tinned for connection to the external device.

Table 1-8 Non-Isco Pump Cable, P/N 69-2134-170

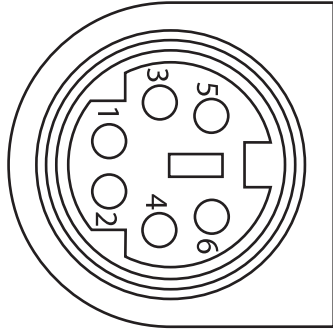
Connector	Pin	Color	Type	Description
	1	BLK	Input	Count: pump volume signal
	2	BRN	Output	Pump pause: stops pump between tubes and at end of run
	3	RED	Output	Valve output: control signal for optional high flow diverter valve
	4	ORN	Common	Circuit common
	5	YEL	Output	+24 VDC Output: power for optional high flow diverter valve
	6	GRN	Not used	
	K	N/A	Shield	Earth ground

1.6.3 Cable for non-Isco Detectors

A cable is available to connect the fraction collector to a non-Isco detector. Part number 69-2134-171 is a six-foot long cable with one end terminated as a 8-pin mini-DIN connector. The other end is stripped and tinned for connection to the external device.

Table 1-9 Non-Isco Detector Cable, P/N 69-2134-171

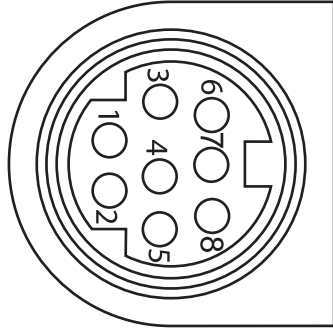
Connector	Pin	Color	Type	Description
	1	BLK	Common	Analog common for use with pin 8
	2	BRN	Input	Ext peak:
	3	RED	Not used	
	4	ORN	Output	Event: pulse delivered at tube change
	5	YEL	Input	Inject: starts an inject cycle
	6	GRN	Input	Tube Advance
	7	BLU	Common	Circuit common
	8	VIO	Input	Analog detector signal: used for peak detection
K	N/A	Shield	Earth ground	

Foxy[®] R1 and Foxy[®] R2 Fraction Collectors

Section 2 Preparation for Use

This section describes the setup procedures for the fraction collector and its optional accessories.

 **Note**

Section 2.5 contains an Installation Qualification checklist. If required, sign off the checklist entries as you successfully complete the following sections.

Before attempting to assemble or operate the fraction collector, ensure that all parts, including tube racks or funnels, listed on the packing slip are in the shipping carton(s).

 **CAUTION**

Never lift the fraction collector by the arm. Permanent damage to the arm mechanism may occur.

 **Note**

Optional accessories ordered with the fraction collector might be shipped in a separate carton.

Inspect the fraction collector for damage that might have occurred during shipping. Notify the shipping carrier immediately if you find any damage.

2.1 Preliminary Checkout

Before using the fraction collector you should perform a preliminary checkout to ensure it functions properly. This includes testing electrical, mechanical, and programming functions. To do this, enter a simple program and operate the fraction collector.

 **WARNING**

The AC mains power cord is the disconnect device. Position the fraction collector so that the power cord can be unplugged, or use a power strip where the plug can quickly be removed from the outlet in the event of an emergency.

 **WARNING**

Refer to the serial number label for mains power requirements.

✓ Note

To perform the preliminary checkout you will need to power the fraction collector. The fraction collector is shipped with either a North American IEC320C13 to NEMA 5-15P power cord or a European IEC320C13 to CEE7/VII power cord. If the cord does not fit your AC mains power source, purchase a connector adapter or IEC320C13 power cord from a local vendor.

⚠ CAUTION

Do not install racks, tubing, or any accessories until the preliminary checkout has been completed.

Should the fraction collector fail any preliminary checkout step, contact the factory or your factory-authorized representative.

1. Set the fraction collector upright on a level surface.
2. Remove any wrapping or packing materials from the fraction collector. The arm and diverter valve assembly should move freely.
3. Loosen the diverter valve thumb screw(s) and raise the diverter valve to its highest position (Figure 2-1). Tighten the thumb screw(s) to secure the diverter valve.
4. Connect the fraction collector to AC mains power using the supplied power cord. This places the fraction collector in the Standby mode. The display should be off.
5. Touch the touch screen display to turn on the fraction collector. The drop former will find the home position (left, rear position) and the touch screen display backlight will turn on. The display will briefly show the current rack configuration and then the main menu.

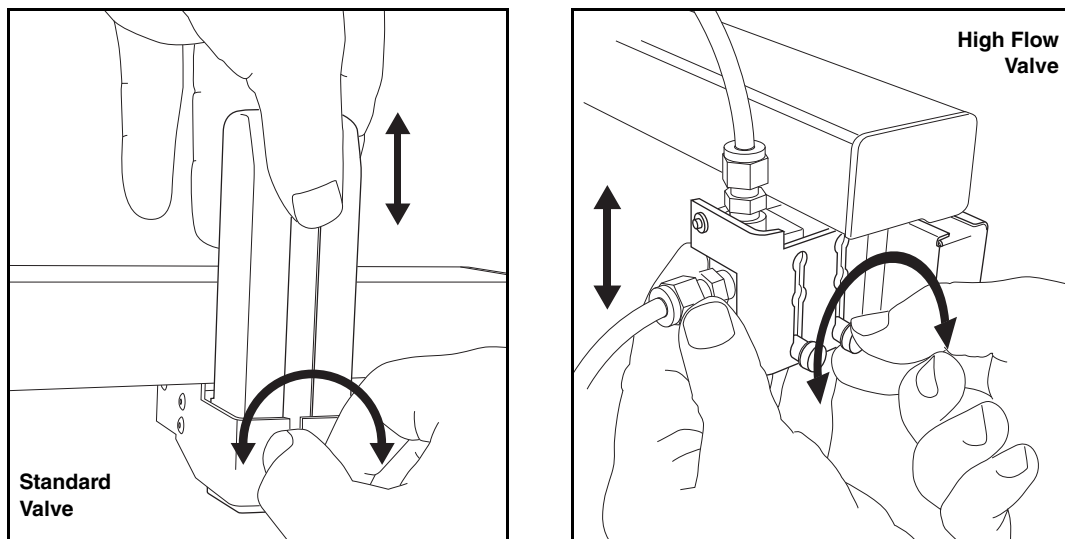

Figure 2-1 Adjusting the height of the standard (left) and high flow (right) diverter valves

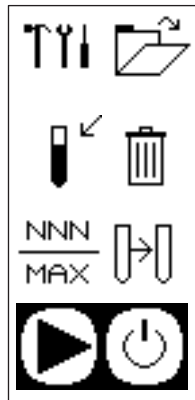

Figure 2-2 Main menu

Note

Appendix A contains an icon glossary for complete descriptions of the icons used in the preliminary checkout procedure.

6. Touch the Folder icon twice to open a list of collection methods. Method A should be selected. If not, touch the up or down arrows to highlight Method A.

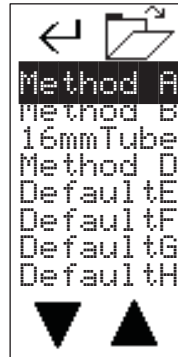

Figure 2-3 Method Select screen

7. Touch the Enter icon to accept Method A and return to the screen at which you can edit the method settings.

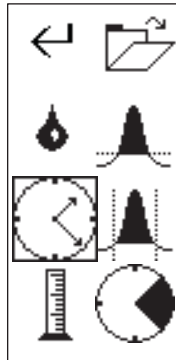

Figure 2-4 Edit Method Settings screen

8. Touch the Time icon to display a screen at which you can modify the fraction collection based on time.
9. The fraction size option should be selected. That is, a box should appear around the tube. If not, touch the Volume Select icon to toggle between the options.
10. Use the Arrow icons to set the interval to two seconds.
11. Touch the Enter icon twice to save the setting and return to the main menu.

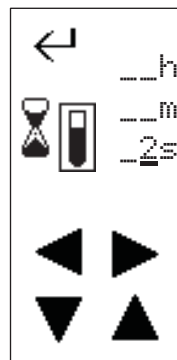

Figure 2-5 Time-based Fractions screen

12. Touch the Play icon to start operation. The arm and drop former will move to the first tube position and then advance to the next tube every two seconds. Allow the drop former to advance through at least 20 tubes to ensure that the arm freely moves through the X and Y axes.
13. Touch the Pause icon. The arm and drop former should stop over the current tube.
14. Touch the Stop icon. The arm and drop former will move to the home position.
This completes the preliminary checkout procedure.

2.2 Fluid Connections

There are three points for fluid connections on the fraction collector. Two are on the diverter valve—In and Waste. The third point is found on the drip tray which you can route to a waste container.

CAUTION

Risk of fire or explosion. Nonconductive, nonpolar liquids at linear velocities greater than 40 cm/sec may develop an electrostatic charge. If this applies to your application, use conductive tubing and ground the fluid path.

Refer to section 2.2.1 for instructions on connecting tubing to the standard diverter valve. Refer to section 2.2.2 for instructions on the high flow rate valve connections. Both valves are shown in Figure 2-1 on page 2-2.

2.2.1 Standard Diverter Valve Connections

Note

The In and Waste connections use special headless fittings. The position of the ports prevent the use of standard Upchurch fittings.

Figure 2-6 shows the standard diverter valve ports.

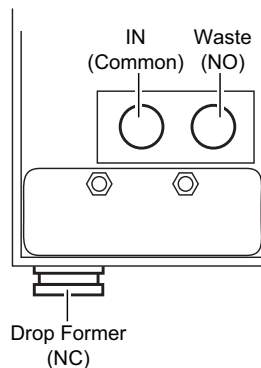

Figure 2-6 Diverter valve ports

To connect the fluid lines:

1. Place the unit in Standby by touching the Standby/ON icon.
2. Remove any installed racks.
3. Loosen the diverter valve thumb screw and lower the diverter valve to its lowest position (refer to Figure 2-1). This will expose the ports on the back of the diverter valve. Tighten the thumb screw to secure the diverter valve.

4. The accessory package includes a 10 ft length (3 m) of tubing. Cut a length of tubing to connect between the In port and the source.

✓ Note

Cut the tubing with a tubing cutter to ensure that the end is cut cleanly and free from any deformation.

5. Prepare the tubing as shown in Figure 2-7.

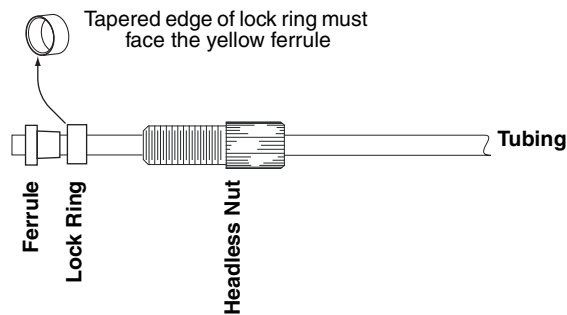

Figure 2-7 Tubing preparation

6. Insert the tubing into the In port. With the tubing fully seated, thread the headless nut into the port until finger-tight.
7. Unthread the headless nut and inspect the fitting. The ferrule should be fully swaged at the end of the tubing. The following should be observed:
 - the yellow ferrule should be flush and perpendicular with the end of the tubing,
 - the metal lock ring should be compressed over the ferrule without any gaps,
 - all pieces should be correctly aligned and free from any deformation.If not fully swaged, reinsert the headless nut into the port and tighten further. Remove the headless nut and inspect again using the criteria above.
8. Repeat steps 4 through 7 to prepare the tubing for the Waste port.
9. Route the headless nuts of the In and Waste fluid lines down through the tubing guide on the back of the arm. The tubing should be routed behind the metal guide pin.
10. Connect the fluid In line to the center port. Connect the other end to the liquid source with user-supplied fittings.

11. Connect the Waste line to the right-side port (when viewed from the back of the diverter valve). Route the other end to a waste collection container. The completed connections should appear as shown in Figure 2-8.

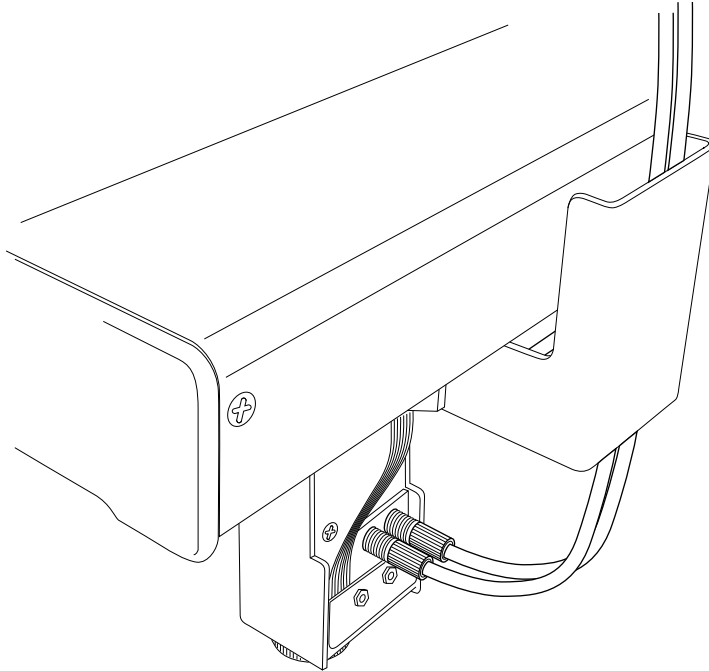

Figure 2-8 Connections to standard diverter valve

12. Raise the diverter valve to its highest position.
13. Move the arm and diverter valve through the full range of motion. Ensure the In and Waste tubing do not obstruct the movement. If necessary, secure the tubing using the adhesive-backed clips from the accessory package.

2.2.2 High Flow Diverter Valve Connections

Figure 2-9 shows the high flow diverter valve ports.

To connect the fluid lines:

1. Place the unit in Standby by touching the Standby/ON icon.
2. Remove any installed racks.
3. The accessory package includes a 42 inch (107 cm) length for the In port and the source. The accessory package also includes an 8 ft (2.4 m) length of tubing for the Waste port. Cut each tubing piece to the desired length.

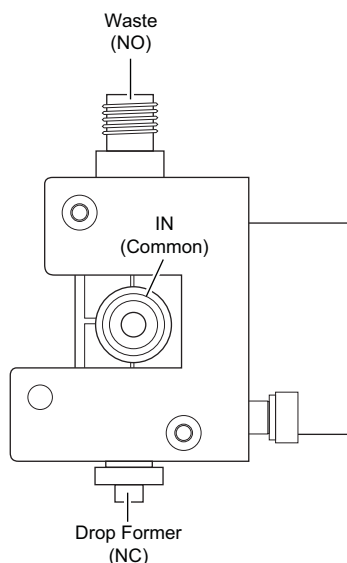

Figure 2-9 High flow diverter valve ports (front view)

CAUTION

Risk of fire or equipment damage caused by electrostatic discharge. Organic solvents delivered at high flow rates can build an electrostatic charge. The conductive black tubing supplied in the kit dissipates the electrostatic charge. If handling organic solvents at high flow rates, do not substitute the conductive tubing.

Note

Cut the tubing with a tubing cutter to ensure that the end is cut cleanly and free from any deformation.

4. Prepare one end of each tubing piece as shown in Figure 2-10.

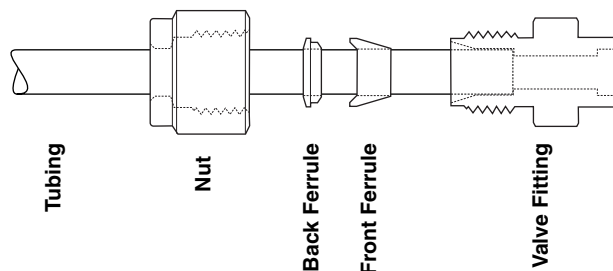

Figure 2-10 Tubing preparation, high flow

5. Using two wrenches, connect the In and Waste tubing to the valve using caution to prevent damage to the plastic valve body.



CAUTION

Plastic valve body damage possible. While swaging the tubing connections, always use two wrenches to prevent turning the metal fittings in the plastic valve body. Use one wrench to hold the inside nut to keep it from turning. Use the second wrench to turn the outer nut.

6. Connect the other end of each tubing piece to their respective source or waste container.
7. Ensure that the diverter valve is in the highest position.
8. Move the arm and diverter valve through the full range of motion. Ensure the In and Waste tubing do not obstruct the movement. If necessary, secure the tubing using the adhesive-backed clips from the accessory package.

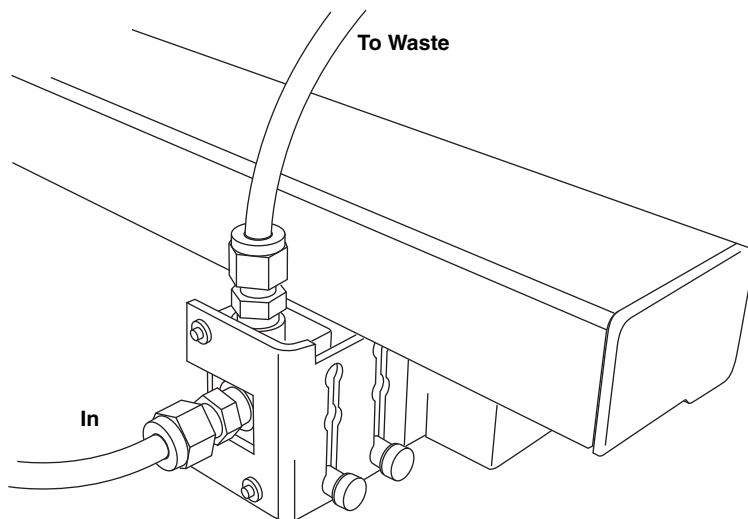

Figure 2-11 Connections to high flow diverter valve

2.2.3 Drip Tray Drain Connection

Connect the $\frac{5}{16}$ inch I.D. clear vinyl tubing to the drip tray drain and route it to a suitable waste container.

CAUTION

Connect tubing to the drip tray drain when collecting large volumes, when the installed location is at risk from any overflow, or when collecting fluids that are flammable or can produce flammable vapors.

CAUTION

To prevent fluid from pooling, drain tubing must slope downward from the drip tray without loops or kinks. If necessary, elevate the fraction collector by placing it on a sturdy shelf or platform.

 **CAUTION**

Visually inspect the drain tubing monthly to ensure that it is not obstructed. The tubing should be free of any damage, kinks, deterioration, or obstructions.

2.3 Rack Installation

The fraction collectors hold either one or two racks. Racks ensure that the collection vessels are positioned correctly under the drop former. Racks are also a convenient way to prepare the fraction collector for operation, as well as carrying or storing collected fluids after operation.

 **Note**

To prevent spills, always insert the correct vessels in the rack and verify that the rack is aligned on the guide pins.

 **Note**

The Foxy R2 fraction collectors will detect the installed rack using RFID technology, and configure the operation settings for the detected rack and tube size.

To install a rack:

1. Select the rack and insert the collection tubes.

 **Note**

Collection tube height must not exceed 150 mm for use with the Foxy R1 fraction collector. Tube height must not exceed 180 mm for use with the Foxy R2 fraction collector.

2. Ensure that the tops of the collection tubes are even. Tubes that do not drop fully into the rack might obstruct arm movement.
3. Grasp the rack so that tube 1 is positioned at the front left corner.
4. Align the holes on the left side of the rack with the corresponding guide pins (Figure 2-12) in the drip tray and gently press downward. When correctly installed, both sides of the rack will sit on the ridges in the drip tray. The test tube numbers on the rack will appear upright when viewed from the front of the fraction collector.

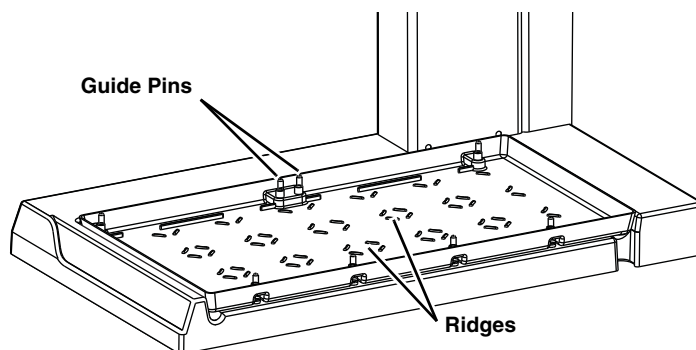

Figure 2-12 Rack guide pins and bottle location ridges

 **CAUTION**

Risk of fire or explosion. Nonconductive, nonpolar liquids at linear velocities greater than 40 cm/sec will develop an electrostatic charge. If this applies to your application, racks must be installed correctly on the guide pins to ground the collection vessels. An electrical ground is necessary to dissipate electrostatic charges that may build while collecting fluids such as organic solvents.

5. Verify that the spring-loaded post on the left side of the rack is touching the guide pin (Figure 2-13).

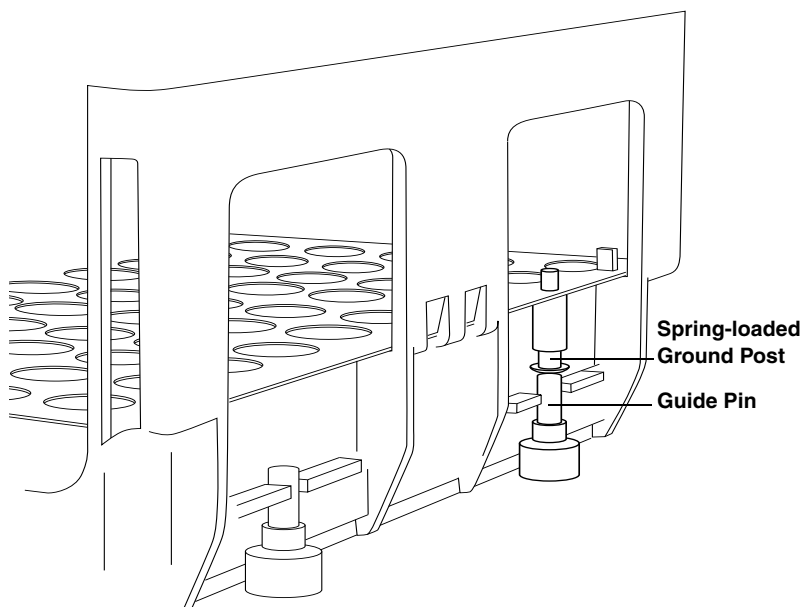

Figure 2-13 Rack installed with ground post touching guide pin

2.4 Diverter Valve Adjustment

The height of the diverter valve should be adjusted to minimize the distance above the collection tubes.

This vertical adjustment should be performed whenever different types of racks or collection tubes are installed.

CAUTION

To prevent damage to the arm, drop former, or collection tubes, always adjust the diverter valve to its highest position before installing different types of racks or tubes. After installing racks and tubes, lower the diverter valve to its operating position.

1. Ensure that the unit is in Standby. If not, touch the Standby/On icon to place the unit in Standby.
2. Move the arm and drop former to a convenient location over the installed collection rack.
3. While holding the diverter valve with one hand, loosen the thumb screw(s) with the other. Do not remove the thumb-screw(s).
4. Lower the diverter valve so that the drop former is close to the top of the collection tubes (Figure 2-14). Generally, a 1/2-inch or 1 cm space between the drop former and the top of the tubes will sufficiently allow unobstructed movement of the arm.
5. Tighten the thumbscrew(s) to secure the diverter valve position.
6. Move the diverter valve over the tubes in each corner of the rack to ensure there is clearance.
7. Turn on the fraction collector by touching the touch screen display. The arm will return to the home position. The drop former should clear the top of the tubes.

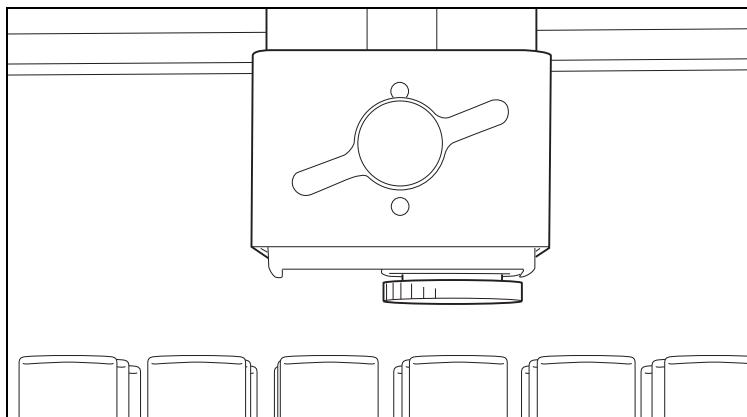

Figure 2-14 Diverter Valve adjusted with 1/2 inch or 1 cm clearance (standard diverter valve shown)

Foxy[®] R1 and Foxy[®] R2 Fraction Collectors

Section 3 Programming

This section contains an overview of fraction collection programming via the touch screen interface.

Programming via the touch screen supports basic collection applications where the fraction collector is one of several discrete components with or without a main controller. Control signals, if any, are connected to the Pump or Detector connectors on the back panel.

For advanced collection applications where the fraction collector is part of a system directed by an external controller, refer to Section 4, *Serial Command Control*. The fraction collector in these applications is interfaced with an external controlling device through the RS-232 Serial or Ethernet connectors, as well as the optional pump and detector inputs.

Note



The display shows a computer icon if the system is under remote control. Refer to Section 4 for serial control programming instructions and to the documentation supplied with the controlling device.

Should there be a need to control the fraction collector locally, touch the computer icon to terminate the remote control.

Note



The display shows a lock icon if the system is under exclusive remote control. Refer to the documentation supplied with the controlling device for programming instructions.

Additional touch screen programming resources can be found in Appendix A.

3.1 Main Menu

All programming via the touch screen begins at the Main Menu (Figure 3-1).

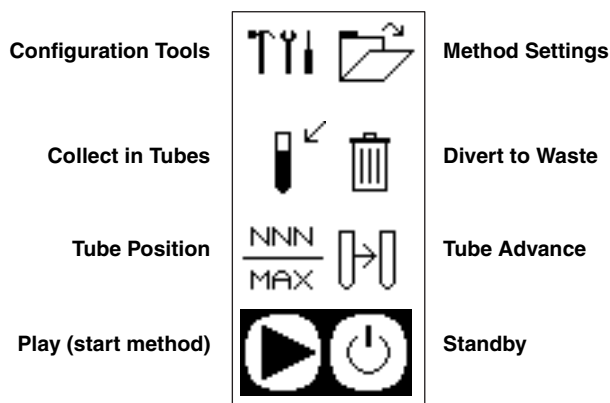





Figure 3-1 Main Menu

Access the fraction collector programming by touching either the Tools icon or the Folder icon:

 Touch the Configuration Tools icon to view or modify the fraction collector **Configuration** settings such as the rack type, input/output settings, *etc.* The Configuration settings should be reviewed and set as required when the fraction collector is first installed, and whenever the configuration is changed thereafter. Refer to Section 3.2 for details.

 Touch the Folder icon to view or modify the **Method** settings. The Method settings direct the operation of the fraction collector after you touch the Play icon. These settings define tube change intervals, peak cutting, time windows, *etc.* Up to eight different methods can be defined, one of which is always current. For more details see Section 3.3.

The other Main Menu icons are briefly discussed below:

 Touch the Diverter Valve Position icons to toggle the position of the diverter valve. When the arrow points to the tube, the valve is set to collect fluids in tubes. When the arrow points to the waste can, the valve is set to route fluids to waste.

 Touch the Next Tube icon to advance the drop former to the next tube position. The current tube position is reported next to this icon.

 Touch the Play icon to start the current method.

 Touch the Power icon to place the fraction collector in the Standby state.

3.2 Configuration Settings

Configuration settings define the overall fraction collector operation. That is, these global settings are applicable regardless of whichever collection Method is selected.

The fraction collector displays the Configuration menu (Figure 3-2) when you touch the Configuration Tools icon.

When you first install the fraction collector, these settings should be reviewed and set as necessary. Also, update the settings whenever the configuration changes. Sections 3.2.1 through 3.2.7 provide details for each of the Configuration Tools menu options.

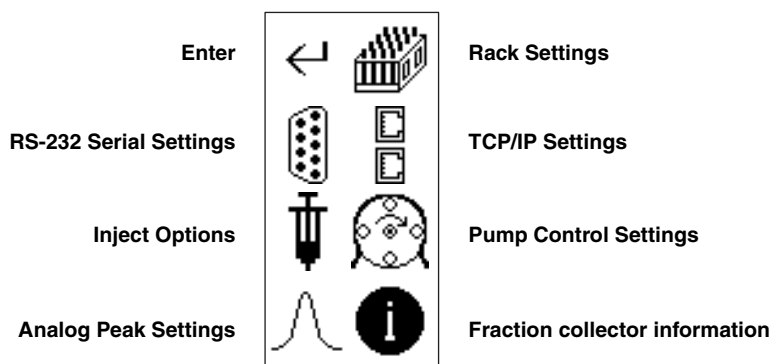

Figure 3-2 Configuration Tools Menu

3.2.1 Rack Settings



Touch the rack icon to view the Rack options menu (Figure 3-3). From this menu you can view or change the type of rack, set the collection pattern and speed, and calibrate the drop former position over the rack.

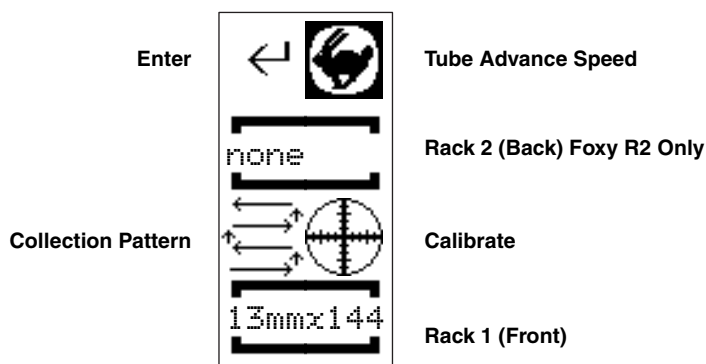

Figure 3-3 Rack options menu

Rack 1 and Rack 2

 **Note**

The two-rack Foxy R2 fraction collector uses radio frequency identification (RFID) technology to automatically detect the rack types. The Rack options menu displays the detected rack types.

The Rack 1 and Rack 2 options report the current Rack type. On the Foxy R2 fraction collector, rack types are automatically detected whenever the touch screen display returns to the Main menu. Therefore, setting the rack type for the Foxy R2 is not necessary.

To change the rack type (not recommended on Foxy R2 fraction collectors):

1. Touch the Rack 1 or Rack 2 settings to open a list of supported rack types.
2. Select the desired rack type from the list using the Up and Down Arrow buttons.

 **Note**

The selected rack type should match the installed rack. Otherwise, fluids may miss the collection tube openings.

3. If you intend to use fewer tubes than the capacity of the rack, touch the Number of Tubes icon. Use the Arrow icons to specify the last tube in the rack, then touch the Enter icon to accept the value.
4. Touch the Enter icon to save the selection and return to the Rack Options menu.

 **Note**

Touching the Enter icon again will return the fraction collector to the Configuration Tools menu. Touching it once more will display the Main menu.

Tube Advance Speed

The fraction collector can vary the speed of the tube advance motion. Higher flow rate, or higher viscosity liquids may cause some liquid to miss the tube opening during tube changes. The Tube Advance Speed setting allows you to minimize this effect.

To adjust the Tube Advance Speed:

1. Touch the Tube Advance Speed (Rabbit) icon.
2. The left side of the display shows the speed setting. Increase or decrease the speed by touching the rabbit (faster) icon or the turtle (slower) icon.
3. Touch the Enter icon to save the calibration settings.

Collection Pattern

The collection pattern icon displays the selected pattern—either left-to-right or serpentine. Touch the icon to toggle the selections.

Calibrate

The factory calibration positions the drop former over the collection tubes for all available rack types. Calibration is not necessary for most applications and commercially-available collection vessels.

Some applications or collection vessels require calibration to further refine the drop former position. This need is evident when the drops fall on or beyond the rim of the collection vessel.

Note

If the only drops that fall on or beyond the rim are those immediately following a tube advance, the problem is not due to calibration. Instead, lowering the drop former (section 2.4) or adjusting Tube Advance Speed might prevent this condition. Additionally, consider stopping the fluid delivery pump during tube changes (Section 3.2.5).

Should calibration be necessary:

1. Ensure that the fraction collector is level.
2. Load the rack with the collection vessels and place the rack on the system.
3. Touch the Calibrate icon to access the calibration options.
4. Touch the First Tube icon to move the drop former over the front and left-most tube in the rack.
5. Touch the Arrow buttons to incrementally position the drop former over the center of the collection vessel opening.

Note

The white diverter valve housing has a arrow on the face to indicate the center of the drop former outlet. This can assist with the left-to-right (X-axis) positioning.

6. When the first tube position is calibrated, touch the Last Tube icon to move the drop former over the back and right-most tube.
7. Touch the Arrow buttons to position the drop former over the center of the collection vessel opening.
8. Touch the enter icon to save the calibration settings.

By calibrating the drop former position over the first and last tubes, the fraction collector calculates the position of all other tubes in the rack.

3.2.2 RS-232 Serial Settings



External devices can communicate with the fraction collector. One option is through the RS-232 Serial port. Many of the communication parameters are predefined by the firmware:

- Supports ASCII printable characters
- 8-bit
- No parity bit
- 1 stop bit.

The user-configurable parameter is the baud rate. To set the baud rate:

1. Touch the RS-232 Serial settings icon.
2. Select the desired baud rate from the list using the Up and Down Arrow buttons.
3. Touch the Enter icon to save the selection and return to the Configuration Tools menu.

 **Note**

Refer to Section 4 for more information on communications with external devices.

3.2.3 TCP/IP Settings



External devices may communicate with the fraction collector using TCP/IP protocol and a static IPv4 address. To configure the TCP/IP settings:

1. Touch the TCP/IP settings icon to display the communication options.
2. Review the IP and IP Mask values. To change either value:
 - a. Touch the value you intend to modify.
 - b. Touch the Up and Down Arrow icons to set the numerical value at the cursor position.
 - c. Move the cursor position by touching the Left and Right Arrow icons.
 - d. Touch the Enter icon to save the setting and return to the previous display.

 **Note**

Should you need assistance with determining the correct static IP address and IP Mask values, contact your IT department.

 **Note**

The view-only MAC address is unique to each fraction collector and cannot be changed.

3.2.4 Inject Options



None

Inject or timed

Inject options, also known as Restart options, control the operation of the fraction collector when collecting fractions from multiple samples.

Touching the Inject icon displays a list of options.

If you intend to collect fractions from a single sample after touching the Play button, select the None option. The fraction collector will collect fluids until the last tube, or until stopped.

If you intend to collect fractions from multiple samples during a run, choose an Inject or Timed option. The difference is the means used to restart the collection of each sample.

Inject – The inject options rely on an Inject signal from an external device. The fraction collector receives this electrical pulse input on pin 5 of the Detector connector.

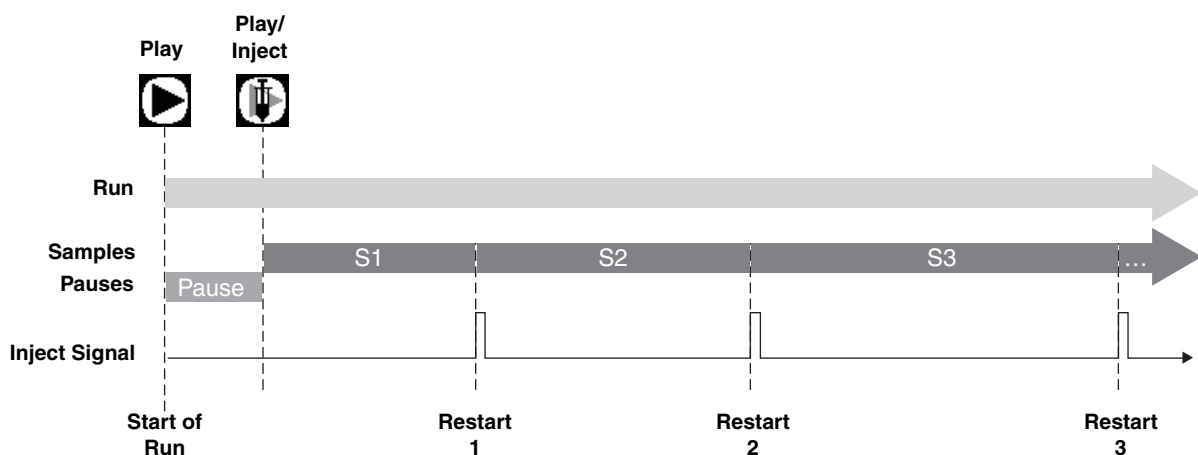

Figure 3-4 Inject options timing diagram

When first started (Figure 3-4, *Start of Run*) using one of the Inject options, the fraction collector pauses so that the sample can be injected, as indicated by the Play icon alternating with the Inject icon. Touch the Play/Inject icon after the sample injection to resume the operation.

The fraction collector advances through collection tubes as programmed by its method settings until it receives an Inject signal (Figure 3-4, *Restart 1*). The fraction collector restarts the collection program and moves to the tube defined by the overlay, next, or skip options. This process repeats until the end of the run.

Timed – The timed options do not rely on external signals, nor does it pause for injections. When using one of the timed options, the fraction collector assumes that each of the multiple sample injections are performed at fixed time intervals.

For example, the chemist injects a sample and touches the Play icon to start the run (Figure 3-5). Thereafter, another sample is injected at every five minute interval. Every five minutes the fraction collector automatically restarts and moves to the tube defined by the overlay, next, or skip options. This process repeats until the end of the run.

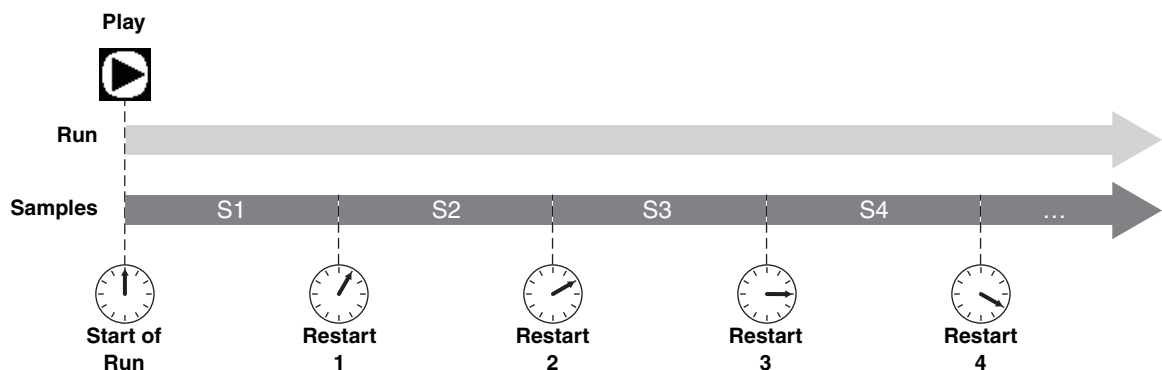

Figure 3-5 Timed options timing diagram

To set the time restart interval:

1. Touch the Arrow buttons to select a Timed option. A Folder icon appears at the top of the display.
2. Touch the Folder icon to open the Timed interval settings.
3. Enter the hours, minutes, and seconds for the interval. Move the cursor position by touching the Left and Right Arrow icons. Touch the Up and Down Arrow icons to set the numerical value at the cursor position.
4. Touch the Enter icon to save the setting and return to the previous display.

Overlay, Next, or Skip

The Inject or Timed restart options are combined with a collection tube option: Overlay, Next, or Skip. These options are illustrated in Figure 3-6.

Overlay – If you select the overlay option, the fraction collector moves the drop former back to the original tube position. That is, at every restart, the drop former returns to the tube position from which the run was started.

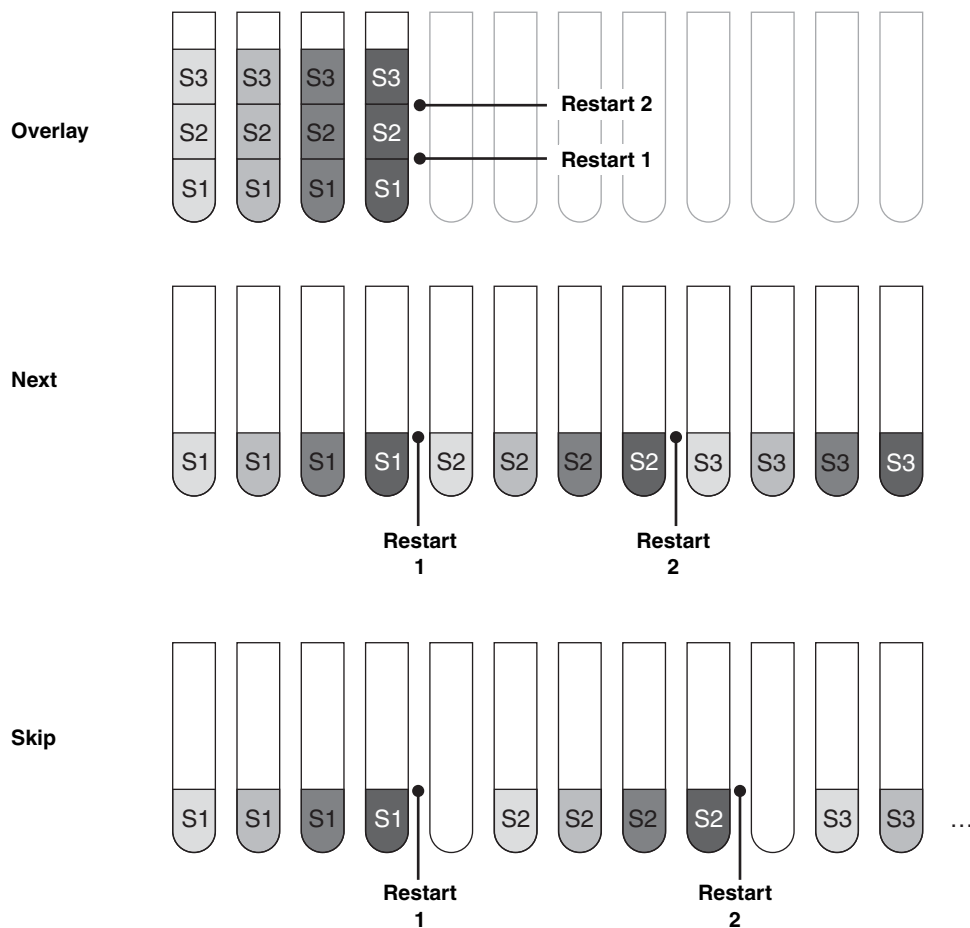

Figure 3-6 Overlay, Next and Skip options diagram

One example of this tube-conserving option's usefulness is to collect like eluate from multiple, identical samples while repeating the same liquid chromatography method. Because the peaks elute the same each time, greater volumes of pure compound can be collected in a tube.

Next – The Next option continues with the next available tube at each restart.

Skip – The Skip option skips one tube and continues with the following tube at each restart. The empty tube helps you locate the sets of tubes for each restart.

3.2.5 Pump Control Settings



The fraction collector can control an external pump from pin 2 of the Pump connector. This signal is used to pause the pump during tube changes.

Touch the Pump Control icon to view the current setting.



The icon with the "1" (left) indicates that the fraction collector will not send a pause signal from pin 2. In this state, the external pump will continue to operate during tube changes. The icon with the "0" indicates that the fraction collector will send a pause signal from pin 2. Touch the icon to toggle the state.

3.2.6 Analog Peak Settings



The fraction collector can receive an analog peak signal from an external detector. The fraction collector receives this signal at pin 8 of the Detector connector.

When using this feature, set the analog peak voltage scale to the range of the detector signal, either 1000 mV, 100 mV, or 10 mV. Touch the Analog Peak setting icon to view and select the range using the Up and Down Arrows.

Choose the voltage that corresponds to your detection device's 100% signal output. If your detector does not scale its output to one of the options, choose the option just above your highest expected peak voltage.

If you select the External option, the fraction collector will ignore the signal at pin 8 and monitor the TTL signal at pin 2 instead. The fraction collector begins cutting peaks when an active low is present.

3.2.7 Fraction Collector Information



Touch the Information icon to display Model number and hardware/firmware revisions.

3.3 Method Settings

Method settings define the fraction collector operation for a run. The fraction collector displays the Method Settings menu (Figure 3-7) when you touch the folder icon on Main menu. Use this menu to program the current method or select another of the eight stored methods.

Refer to section 3.3.1 for information on selecting and naming methods. Sections 3.3.2 through 3.3.7 describe how to program the current method.

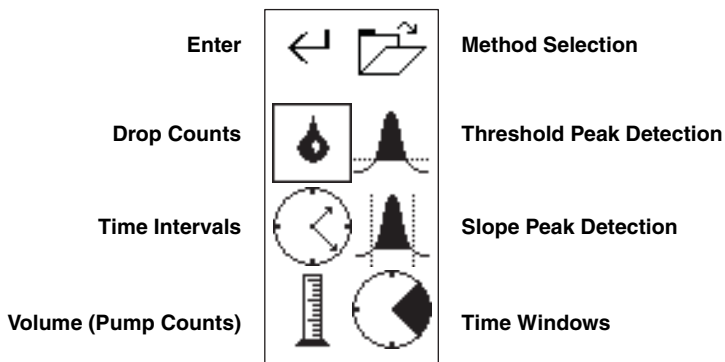

Figure 3-7 Method Settings Menu

3.3.1 Method Selection

To view the name of the current method, touch the folder icon from the Method Settings menu. The displayed list of methods highlights the current method name (Figure 3-8).

To select a different method, use the Up and Down Arrows to highlight the desired method. Touch the Enter icon to accept the new method and return to the Method Settings display.

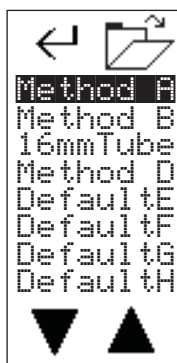

Figure 3-8 Method Selection Menu

You can also rename the methods. After highlighting a method, touch the Folder icon. The fraction collector displays a text editing screen (Figure 3-9) from which you can rename the method.

Use the Left and Right Arrows to move the cursor and the Up and Down Arrows to change the character or number. When complete, touch the Enter icon to save the name and return to the Method Selection menu.

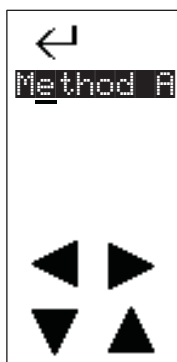

Figure 3-9 Rename Method display

3.3.2 Drop Counts



Drop counting creates fractions by advancing the drop former at a fixed number of drops. This option uses a photosensor device positioned just below the drop former.

Note

Drop counting can create relatively uniform collection tube volumes even when the delivered flow rate varies. However, if the fluid viscosity varies while running a gradient, the collection tube volumes may vary.

Note

The drop count option assumes that the flow rate is slow enough to produce drops instead of a stream of liquid. Consequently, drop counting is not supported by the Foxy R2 *High Flow* fraction collector.

To create fractions based on drop counts:

1. Touch the Drop Count icon to open the settings display (Figure 3-10).

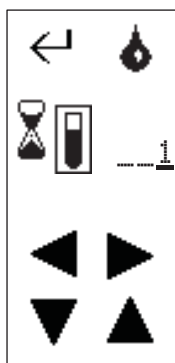

Figure 3-10 Drop Counts display

Use this display to set the fraction volume—expressed as a number of drops, and the flow delay volume—expressed as time.

2. Ensure that the fraction volume setting is active as indicated by the Volume Select icon. That is, the tube should be highlighted with a border. If not, touch the icon to toggle the setting.



3. Enter the fraction volume as 1 to 999 drops using the arrow icons. The Up and Down Arrows increment or decrement the numbers, the Left and Right Arrows move the cursor position.
4. Touch the Volume Select icon to display the Flow Delay volume. The hourglass should be highlighted with a border.



5. Enter the Flow Delay volume as hours, minutes, and seconds using the Arrow icons. The Up and Down Arrows increment or decrement the numbers, the Left and Right Arrows move the cursor position.
6. Touch the Enter icon to return to the Methods Settings menu.

About Flow Delays

A Flow Delay synchronizes the tube changes with sample flow to make precise peak cutting possible. The flow delay time is the time required for a fraction to travel from your detector to the fraction collector's drop former. The delay depends on the flow rate and the size of the tubing between the fraction collector and the detector.

To calculate the flow delay time, use this formula:

$$T = V/Q$$

Where T is the delay time in seconds, V is the internal volume of the tubing, and Q is the flow rate, (in the same units as V) per second.

The volume of the tubing can be calculated by:

$$V = \pi/4 \times D^2 \times L \quad \text{or expressed as:}$$
$$V = 0.7854 \times D^2 \times L$$

where L is the tubing length (cm) and D is the inside diameter (cm). The resulting volume is in milliliters.

An easy, alternative way to find the delay time is to introduce a bubble ahead of the detector and measure the delay to the drop former.

3.3.3 Time Intervals



Time intervals create fractions by advancing the drop former at a fixed time intervals. This option uses an internal clock.

Note

Time intervals can create widely varying collection tube volumes if the delivered flow rate is variable.

To create fractions based on time intervals:

1. Touch the Time Intervals icon to open the settings display (Figure 3-11).

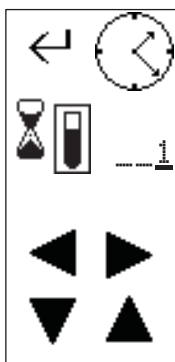

Figure 3-11 Time Intervals display

Use this display to set the fraction volume and delay volume—both expressed as hours, minutes, and seconds.

2. Ensure that the fraction volume setting is active as indicated by the Volume Select icon. That is, the tube should be highlighted with a border. If not, touch the icon to toggle the setting.



3. Enter the fraction volume as hours, minutes, and seconds using the arrow icons. The Up and Down Arrows increment or decrement the numbers, the Left and Right Arrows move the cursor position.
4. Touch the Volume Select icon to display the Flow Delay. The hourglass should be highlighted with a border.



5. Enter the Flow Delay volume as hours, minutes, and seconds using the Arrow icons. The Up and Down Arrows increment or decrement the numbers, the Left and Right Arrows move the cursor position.
6. Touch the Enter icon to return to the Methods Settings menu.

3.3.4 Volume



The Volume option creates fractions by advancing the drop former at a fixed number of pump counts. This option relies on a pump count signal delivered by an external device to pin 1 of the fraction collector's Pump connector.

Note

The Volume option can create relatively uniform collection tube volumes even when the delivered flow rate varies.

Refer to the documentation provided by the pump manufacturer to determine the volume delivered for each pump count.

To create fractions based using the volume option:

1. Touch the Volume icon to open the settings display (Figure 3-12).

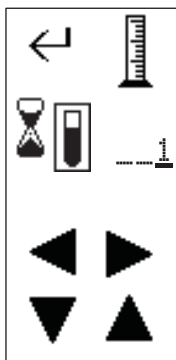

Figure 3-12 Volume display

Use this display to set the fraction volume and delay volume—both expressed as pump counts.

2. Ensure that the fraction volume setting is active as indicated by the Volume Select icon. That is, the tube should be highlighted with a border. If not, touch the icon to toggle the setting.



3. Enter the fraction volume as 1 to 999 counts using the arrow icons. The Up and Down Arrows increment or decrement the numbers, the Left and Right Arrows move the cursor position. For example, if the pump delivers 2 mL each pump count and the fraction size should be 24 mL, enter 12 pump counts.
4. Touch the Volume Select icon to display the Flow Delay. The hourglass should be highlighted with a border.



- Enter the Flow Delay volume as 1 to 999 counts using the arrow icons. The Up and Down Arrows increment or decrement the numbers, the Left and Right Arrows move the cursor position.

To calculate the number of pump counts for the delay volume:

$$P_{\text{counts}} = (\pi/4 \times D^2 \times L) / P_{\text{vol}}, \text{ otherwise expressed as:}$$

$$P_{\text{counts}} = (0.7854 \times D^2 \times L) / P_{\text{vol}}$$

Where L is the tubing length and D is the inside diameter. P_{vol} is the volume delivered for each pump count. Round to the nearest whole number.

Note

For the greatest possible flow delay volume accuracy, cut the tubing so that it holds a multiple of the of the pump count volume.

- Touch the Enter icon to return to the Methods Settings menu.

3.3.5 Threshold Detection



Threshold detection isolates the most concentrated portion of peaks. The threshold is set as a percentage of the maximum input signal. When the input signal rises above this threshold value, the fraction collector performs a tube advance to isolate the peak.

An example of threshold peak detection and collection is shown in Figure 3-13. The peaks on the analog signal are numbered 1 through 4. The fraction collector ignores the first peak because it is below the 10% threshold. It isolates peaks 2 through 4 in collection tubes because the peak signal exceeds the threshold.

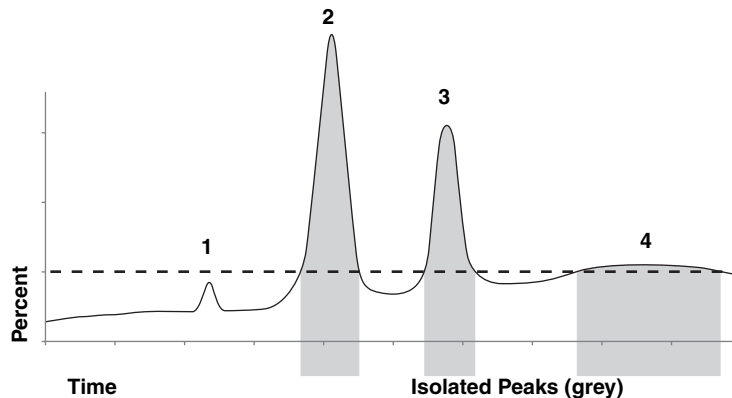

Figure 3-13 Threshold detection cuts peaks when external peak signal exceeds set percentage

To program the fraction collector for Threshold peak detection:

1. Touch the Threshold Detection icon from the Method Settings menu to open the threshold menu (Figure 3-14).

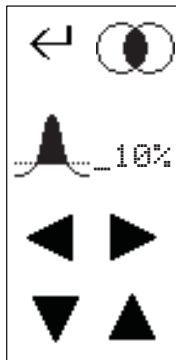

Figure 3-14 Threshold Settings menu

2. Enter the threshold as 1 to 99 percent using the Arrow icons. The Up and Down Arrows increment or decrement the numbers, the Left and Right Arrows move the cursor.
3. The icon next to the percentage shows what the fraction collector will do with non-peak fluids. The icon that is clear below the threshold indicates that non-peak fluids will be diverted to waste. The icon that is shaded below the threshold indicates that non-peak fluids will be collected in tubes. Touch the icon to toggle the selection.



4. Threshold peak detection can be used alone or combined with slope detection. You can control these options using the icon in the upper right corner of the display.



- The None icon (left) indicates that Threshold detection is Off.
- The Intersection Venn diagram icon (middle) indicates that both Threshold and Slope detection must be true before the fraction collector isolates the peak. This is also considered a logical AND.
- The Union Venn diagram icon (right) indicates that when either Threshold or Slope detection are true fraction collector isolates the peak. This is also considered a logical OR.

Touch the icon to toggle the selection.

Note

If you are using only threshold detection, select either the Union (OR) or Intersection (AND) option. Ensure that the peak width detection is set to None.

5. Touch the Enter icon to return to the Method Settings menu.

3.3.6 Peak Width Detection



Peak Width detection isolates small and large magnitude peaks. The Peak Width is set as the average time duration of the expected peaks. The fraction collector monitors the slope of the input signal. (Peak width detection is also commonly called Slope detection.) If the rising signal is consistent with that of a peak, the fraction collector isolates the fluid. In a similar way, the falling slope as it transitions to the baseline indicates the end of a peak. The internal slope detection algorithms are effective in isolating multiple “shouldered,” peaks — peaks that do not return to the baseline before the next peak occurs.

The peak width option is useful to eliminate false peaks that can result from a rising or noisy baseline.

An example of Peak Width detection and collection is shown in Figure 3-15. The peaks on the analog signal are numbered 1 through 4. The fraction collector isolates peaks 1 through 3 in collection tubes because of the slope of the peak signal. Peak 4 is ignored because the signal does not indicate a slope within the programmed peak width setting.

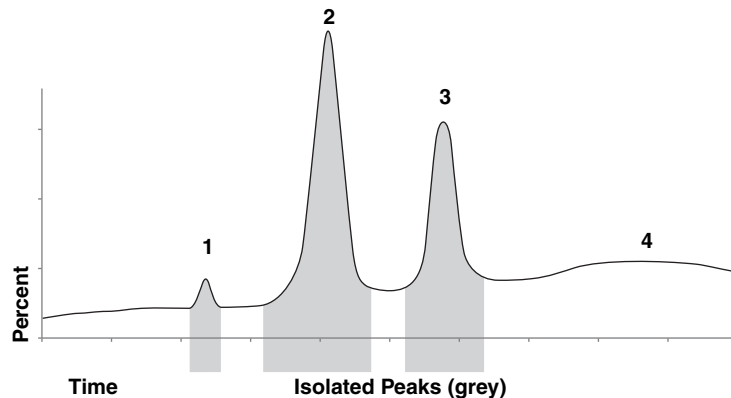

Figure 3-15 Peak Width detection cuts peaks when internal slope algorithms indicate a peak

To program the fraction collector for Peak Width detection:

1. Touch the Peak Width Detection icon from the Method Settings menu to open the threshold menu (Figure 3-16).

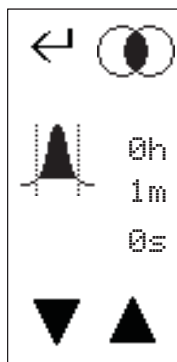

Figure 3-16 Peak Width Settings menu

2. Enter the average peak width using the Up and Down Arrow icons. The Up and Down Arrows scroll through the available Peak Width settings.

Enter the average time duration of the expected peak, as measured at the baseline. The fraction collector will use this average time to detect peaks with widths ranging from .2 to 2 times the programmed width. For best results, choose the next larger peak width if your expected peak width falls between the available options. For example, If you expect a peak of 45 seconds, enter an average peak width of one minute. The fraction collector will detect peaks with widths ranging from 9 seconds to 2 minutes.

3. The icon next to the percentage shows what the fraction collector will do with non-peak fluids. The icon that is clear below the threshold indicates that non-peak fluids will be diverted to waste. The icon that is shaded below the threshold indicates that non-peak fluids will be collected in tubes. Touch the icon to toggle the selection.



4. Peak width detection can be used alone or combined with threshold detection. You can control these options using the icon in the upper right corner of the display.



- The None icon (left) indicates that peak width detection is Off.
- The Intersection Venn diagram icon (middle) indicates that both peak width detection and threshold detection must be true before the fraction collector isolates the peak. This is also considered a logical AND.
- The Union Venn diagram icon (right) indicates that when either peak width detection or threshold detection are true, fraction collector isolates the peak. This is also considered a logical OR. If you are

using only peak width detection, select this Union option.

Touch the icon to toggle the selection.

Note

If you are using only peak width detection, select either the Union (OR) or Intersection (AND) option. Ensure that the threshold detection is set to None.

5. Touch the Enter icon to return to the Method Settings menu.

About Combining Peak Detection Options

The Union and Intersection icons allow you to combine peak detection methods. If you have programmed both peak detection methods this setting will determine whether both or any one of the peak conditions must be true. Refer to the diagrams below for a comparison.

Intersection (AND)

The fraction collector cuts peaks 2 and 3 where the input signal exceeds the threshold value and a slope is determined by the peak width setting.

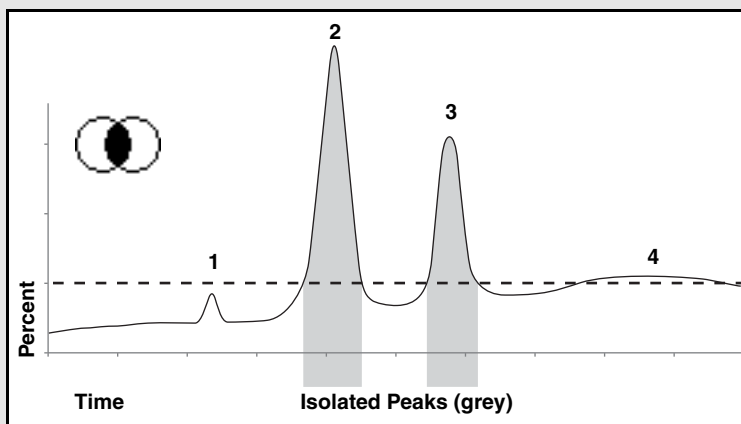

Union (OR)

The fraction collector cuts peaks 1 through 4 wherever the input signal exceeds the threshold value or a slope is determined by the peak width setting.

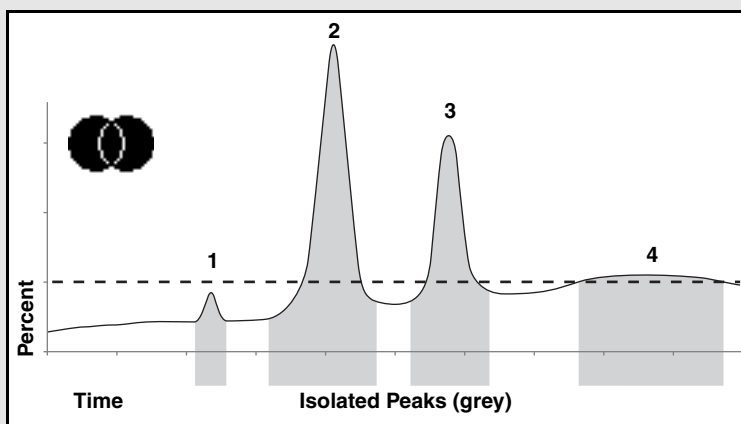

3.3.7 Time Windows

The Time Windows function allows the selection of up to four durations of the running time of which the fraction collector should enable collection. A time window may be used for several applications. For example, one can be used to reject peaks of no interest, to cut peaks to increase the concentration of the sample, or to divert initial waste volume.

An example of this type of collection is shown in Figure 3-20. In this figure two time windows are combined with threshold peak detection. The fraction collector diverts the initial tubing volume and a peak of no interest (1) to waste until the start of Time Window 1. The fraction collector continues to divert fluid to waste until it detects Peak 2 at which time it begins collection until the end of the peak. Peak 3, although it exceeds the threshold, is diverted to waste because it does not occur in a time window. Without a detected peak at the start of Time Window 2, fluid is still diverted to waste until the start of Peak 4. This peak is collected. At the end of Peak 4, the fraction collector briefly diverts fluid to waste until it finishes the run with the end of Time Window 2.

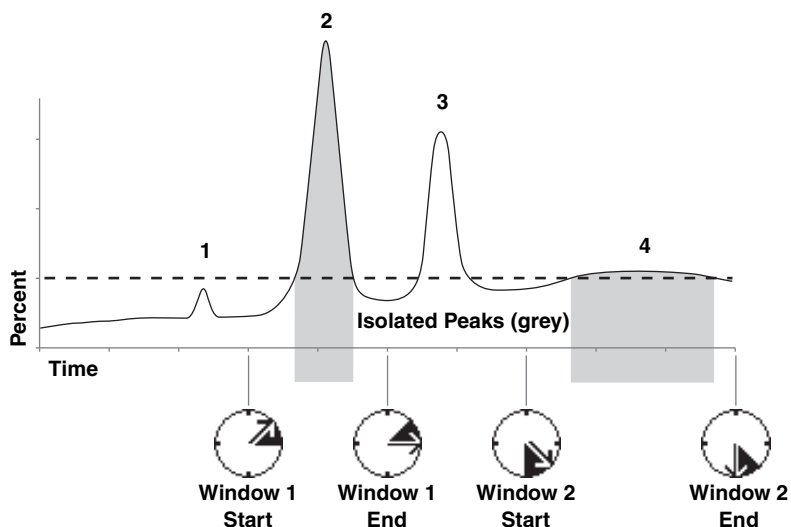

Figure 3-17 Time Windows limit the collection to specific time durations

To program Time Windows:

1. Touch the Time Windows icon from the Method Settings menu to open the menu (Figure 3-18).

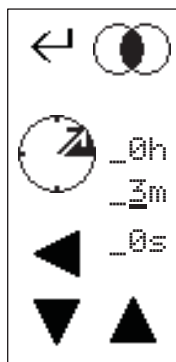

Figure 3-18 Time Windows Settings menu

2. Time Windows are either Off or combined with the selected peak detection where all conditions must be true. Touch the icon in the upper right corner to select the intersection (AND) option.

Note

If a peak detection mode is not used, you must still select the intersection (AND) option to enable Time Window operation.

3. The first displayed time values are for the start of Time Window 1. Enter the start time using the Arrow icons. The Up and Down Arrows increment and decrement the value; the Left Arrow moves the cursor position. The Time Window Start value is the time from the start of the run (pressing the Play icon).
4. Touch the Start/End icon to advance to the end of Time Window 1.
5. Enter the Time Window 1 end time using the Arrow icons. This value is the time from the start of the run.
6. If you are using only one time window, touch the Enter icon to save the settings and return to the Method Settings menu.

To use more than one time window, touch the Start/End icon to advance to the start of Time Window 2. Repeat the steps to enter the start and end values for up to four time windows. When finished, touch the Enter icon to save the settings and return to the Method Settings menu.

Note

When programming or reviewing the Time Windows settings, duplicate values for the start and end of a time window indicates that the current time window is not used. Only the previous time windows will be used in the method.

Foxy[®] R1 and Foxy[®] R2 Fraction Collectors

Section 4 Serial Command Control

4.1 Introduction

The fraction collector has built-in RS-232 and Ethernet interfaces that allow it to be remotely controlled. Remote control is typically done using a computer running a terminal program to send commands and receive data. Software applications such as LabVIEW¹ can automate the fraction collector operation.

4.2 RS-232 Communication Information

The minimum connections required for serial control are:

Pin 2	TRANSMIT	Serial data output to computer
Pin 3	RECEIVE	Serial data input to computer
Pin 5	COMMON	Common for all signals

Available baud rates are 1200, 2400, 4800, 9600, 19200, 38400, 56800, and 115200. Configure the remote device for 8 bits, no parity, 1 stop bit, and no flow control.

4.3 Ethernet Communication Information

Communication with the fraction collector can be established through either Ethernet port. These connections use a Category 5 (or higher) cable. The fraction collector will automatically detect straight and cross-over cables and configure the communication accordingly.

Refer to Section 3 to configure the TCP/IP settings of the fraction collector.

The fraction collector uses port 23 for remote control and communication.

 **Note**

Although the fraction collector uses port 23, commands specific to TELNET protocol will be ignored.

4.4 General Command Information

4.4.1 Character Format

ASCII printable characters are transmitted as 8 data bits, no parity bit, and 1 stop bit.

1. LabVIEW is a trademark of National Instruments Corporation.

Example: Command: CUE=1
Response: >

CUE without an operand returns the current setting.

Example: Command: CUE
Response: CUE=1

ECHO=n This command enables or disables echoing of characters received. Echoing can be used to verify correct reception of characters. ECHO=1 will enable the echoing, ECHO=0 will disable it. ECHO=0 is set when unit is switched to OPERATE.

Example: Command: ECHO=1
Response: (none)

ECHO without an operand returns the current setting.

Example: Command: ECHO
Response: ECHO=1

HELP The unit will respond to this command with a list of valid command names.

Example: Command: HELP
Response: CLEAR COLLECT...

Combining the HELP command with a valid command using the "\$" symbol will return more information for select commands.

Example: Command: HELP\$BAUD
Response: sets & queries the serial port baud rate...

IDENTIFY This commands returns information identifying the unit.

Example: Command: IDENTIFY
Response: SERIES=3870-010, FoxyR1,
FRAC. COL., REV a, 01.00.00

LINEFEED This command enables (LINEFEED=1) or disables (LINEFEED=0) the sending of a linefeed character each time a carriage return is sent. LINEFEED=0 is set when unit is switched to OPERATE.

Example: Command: LINEFEED=1
Response: (none)

LINEFEED without an operand returns the current setting.

Example: Command: LINEFEED
Response: LINEFEED=0

LOCAL This command sets the unit to local mode. In local mode, serial commands cannot affect the unit's operation; commands can only obtain information. Local mode is set when the unit is switched to OPERATE. See REMOTE on page 4-4.

Example: Command: LOCAL
Response: (none)

NOTE=text or NOTE This command and any following text are ignored by the unit. This allows annotating program files for user reference. NOTE without a operand can provide spacing for readability.

Example: Command: NOTE=Use with column 3 at 3
mL/min
Response: (none)

REMOTE This command sets the unit to remote mode. The unit must be put into remote mode before any commands are sent that affect the unit. See also LOCAL on page 4-4.

 **Note**

The touch screen on the unit is still operational in remote mode. You can return the fraction collector to the Local mode from the touch screen by touching the computer icon.

Example: Command: REMOTE
Response: (none)

RSVP This command instructs the unit to indicate completion of the preceding commands that take some time to perform. The response from the unit will be READY when the task is complete. For example, if you have sent RACK=1;RSVP, the unit moves the drop former over the rack and then responds: READY.

Example: Command: RSVP
Response: READY

STATUS The unit will respond to this command with the last warning or failure code that occurred. If an action is in progress, the unit will wait to respond, so a response of STATUS=0 means the preceding commands are complete and no errors occurred. For example, the command string

STATUS=0;RACK=1;TUBE=1;STATUS

will cause the unit to respond with STATUS=0 after the unit has successfully moved to tube 1.

The possible status codes are:

- 0 No Failure
- 1 Failure to home inward minor axis
- 2 Failure to home inward major axis
- 3 Failure to home inward both major and minor axes
- 4 Failure to home outward minor axis
- 5 Failure to home outward major axis
- 6 Failure to home outward both major and minor axes
- 7 Failure of major axis position sensor
- 8 Failure of minor axis position sensor
- 9 Failure of major axis position correction
- 10 Failure of minor axis position correction
- 11 Failure of both major and minor axes position correction

Example: Command: STATUS
Response: STATUS=0

The STATUS=0 command clears the last warning or failure code from memory so that future errors can be noted.

Example: Command: STATUS=0
Response: (none)

Unsupported Miscellaneous Commands The following serial commands are not supported by the Foxy R1 and R2 fraction collector.

- DISPLAY
- KEY=keys

These commands were available for earlier fraction collector models. Do not use them with the Foxy R1 and R2 fraction collectors.

4.5.2 Immediate Control Commands

COLLECT The unit resumes collecting fractions after a DRAIN command if this command is given during a run. Otherwise, this command will instruct the fraction collector to move the drop former over the tubes and open the valve. See also the DRAIN command.

Example: Command: COLLECT
Response: (none)

DETECTOR

The unit responds to this command with the current peak detector input value in volts.

Example: Command: DETECTOR
Response: DETECTOR=0.00014

DRAIN This command halts collecting. If executed during a run, it is the same as touching the Waste icon. The three-way valve diverts the flow to waste. See also the COLLECT command.

Example: Command: DRAIN
Response: (none)

HOME The unit will re-home itself to verify position, even if it is already at home position.

Example: Command: HOME
Response: (none)

NEXTTUBE The unit will advance the current tube number one tube.

Example: Command: NEXTTUBE
Response: (none)

PUMP=n This command sets the pump controlled by the fraction collector on (PUMP=1) or off (PUMP=0).

Example: Command: PUMP=1
Response: (none)

A PUMP command without an operand returns the current setting.

Example: Command: PUMP
Response: PUMP=1

RACK=n This command instructs the unit to move the drop former over the home position (RACK=0) or the racks (RACK=1, RACK=2).

Example: Command: RACK=1
Response: (none)

A RACK command without an operand returns the current position.

Example: Command: RACK
Response: RACK=1

RTUBE=rnnn This command sets the current rack number to r and tube number to nnn and moves the drop former to it if the drop former is not at home. nnn can be from 1 up to the maximum for currently programmed rack type.

Note

nnn must be three characters in length.

Example: Command: RTUBE=1002
Response: (none)

An RTUBE command without an operand requests the rack and tube number the drop former is currently over.

Example: Command: RTUBE
Response: RTUBE=2035

RUN The fraction collector starts, continues, or restarts a run.

Example: Command: RUN
Response: (none)

R1DETECT or R2DETECT (Foxy R2 only) These commands query the two rack RFID readers that are connected to the circuit board. R1DETECT responses with the rack identity of Rack1 (front rack). R2DETECT responses with the rack identity of Rack2 (back rack).

If a rack is not detected, the command will respond with RnDETECT=0.

Example: Command: R1DETECT
Response: 006500100075

If a rack is detected, then the command will typically respond within 500 milliseconds. If a rack is not detected, then the command will timeout and typically respond within 700 milliseconds.

STOP

This command pauses or stops a run. Enter the command once to pause a run in progress. Enter the command twice to completely stop the run. This command is ignored if the unit is not in a collection run.

Example: Command: STOP
Response: (none)

TUBE=n

This command sets the current tube number to 'n' then moves the drop former to it if the drop former is not at home. The 'n' operand can be from 1 up to the maximum for the currently programmed rack type.

Example: Command: TUBE=68
Response: (none)

TUBE without an operand requests the tube number the drop former is currently over.

Example: Command: TUBE
Response: TUBE=45

VALVE=n This command turns the valve on or off. Setting VALVE=0 will cause the flow to the drop former to be diverted to waste with a three-way valve. Setting VALVE=1 will allow flow to the drop former.

Example: Command: VALVE=1
Response: (none)

The VALVE command without an operand returns the current valve state.

Example: Command: VALVE
Response: VALVE=1

Unsupported Immediate Control Commands

The following serial commands are not supported by the fraction collector.

- GRADIENT=n
- OSTATE=n
- OUTPUT=n
- PSPEED=n

These commands were available for earlier fraction collector models. Do not use them with the fraction collectors.

4.5.3 Programming Commands

DEFAULT=1 This command clears the current program to defaults.

 Note

To minimize accidental clearing, the characters "=1" are required.

Example: Command: DEFAULT=1
Response: (none)

DELAY=n This command sets the flow delay of the current program. If FTYPE=1 (fraction by time), then n=0 to 359999 seconds. If FTYPE=2 or 3 (fraction by drops or external counts), then n=0 to 999999 counts. For example, the string FTYPE=1;DELAY=102 sets a flow delay of 1 minute 42 seconds.

Example: Command: DELAY=102
Response: (none)

The DELAY command without an operand returns the current setting.

Example: Command: DELAY
Response: DELAY=102

FSIZE=n This command sets the fraction size for the current program. If FTYPE=1 (fraction by time), n=1 to 359999 seconds; if FTYPE=2 or 3 (fraction by drops or external counts), n=0 to 999999.

Example: Command: FSIZE=23
Response: (none)

The FSIZE command without an operand returns the current setting.

Example: Command: FSIZE
Response: FSIZE=23

FTYPE=n This command sets the fraction type of the current program. Choices are Fraction by Time (FTYPE=1), Fraction by Drops (FTYPE=2), or Fraction by External counts (FTYPE=3).

Example: Command: FTYPE=3
Response: (none)

The FTYPE command without an operand returns the current setting.

Example: Command: FTYPE
Response: FTYPE=3

LAST=n This command sets the last tube of the current program. Choices are n=1 to n=maximum number of tubes for programmed rack type.

Example: Command: LAST=10
Response: (none)

The LAST command without an operand returns the current setting.

Example: Command: LAST
Response: LAST=10

NONPEAK=n This command sets the non-peak/window action of the current program. Choices are Collect (n=1), Divert (n=2), or Drain (n=3).

Example: Command: NONPEAK=3
Response: (none)

The NONPEAK command without an operand returns the current setting.

Example: Command: NONPEAK
Response: NONPEAK=3

PATTERN=n This command sets the rack filling pattern of the current program. Choices are Standard (n=1) or Left-to-right only (n=2).

Example: Command: PATTERN=1
Response: (none)

The PATTERN command without an operand returns the current setting.

Example: Command: PATTERN
Response: PATTERN=1

PROGRAM=n

This command sets the current program number. Choices are n=1 to 8.

Example: Command: PROGRAM=8
Response: (none)

The PROGRAM command without an operand returns the current setting.

Example: Command: PROGRAM
Response: PROGRAM=8

RANGE=n

This command sets the detector signal voltage range of the current program. The choices are:

- n=1 1 Volt
- n=2 100 mV
- n=3 10 mV
- n=4 External detector

Example: Command: RANGE=2
Response: (none)

The RANGE command without an operand returns the current setting.

Example: Command: RANGE
Response: RANGE=2

RESTART=n This command sets the restart action of the current program.

Choices are:

- n=1 None
- n=2 Inject, Overlay
- n=3 Inject, Skip Tube
- n=4 Time, Overlay
- n=5 Time, Skip Tube
- n=6 Inject, Next Tube
- n=7 Time, Next Tube

Example: Command: RESTART=5
Response: (none)

The RESTART command without an operand returns the current setting.

Example: Command: RESTART
Response: RESTART=5

RSTIME=n This command sets the restart time (n=0 to 359999 seconds) of the current program.

Example: Command: RSTIME=600
Response: (none)

The RSTIME command without an operand returns the current setting.

Example: Command: RSTIME
Response: RSTIME=5000

R1LAST=n or R2LAST=n These commands set the last tube for Rack1 or Rack2. Choices are n=1 to n=maximum number of tubes for programmed rack type.

Example: Command: R2LAST=10
Response: (none)

The R1LAST or R2LAST command without an operand returns the current setting.

Example: Command: R2LAST
Response: R2LAST=10

R1TYPE=n or R2TYPE=n These commands set the rack type of the current program. Choices are:

- n=0 none
- n=1 12/13 mm tubes
- n=2 16 mm tubes
- n=3 18 mm tubes
- n=4 17 mm vials
- n=5 25/28 mm vials
- n=6 1.5 mL microcentrifuge tubes
- n=7 36 funnel prep. rack
- n=8 Bottles
- n=9 Single Beaker
- n=10 Microplates, 96 well × 2
- n=11 Microplates, 96 well × 6
- n=12 26 funnel prep. rack

Example: Command: RTYPE=5
Response: (none)

The RTYPE command without an operand returns the current setting.

Example: Command: RTYPE
Response: RTYPE=5

THRESHOLD=n This command sets the peak threshold (n=0 [none] to 100)% of the current program.

Example: Command: THRESHOLD=10
Response: (none)

The THRESHOLD command without an operand returns the current setting.

Example: Command: THRESHOLD
Response: THRESHOLD=10

WIDTH=n This command sets the peak detection width of the current program. Choices are:

- n=1 5 seconds
- n=2 15 seconds
- n=3 30 seconds
- n=4 1 minute
- n=5 2 minutes
- n=6 4 minutes
- n=7 8 minutes
- n=8 16 minutes
- n=9 32 minutes
- n=10 1 hour
- n=11 No slope detection

Example: Command: WIDTH=2
Response: (none)

The WIDTH command without an operand returns the current setting.

Example: Command: WIDTH
Response: WIDTH=2

WINDOW=n

The maximum number of windows is four. This command sets which window number (n=1) will be used for the WSTART and WEND commands that follow.

Example: Command: WINDOW=1
Response: (none)

The WINDOW command without an operand returns the current setting.

Example: Command: WINDOW
Response: WINDOW=1

WSTART=n This command sets the window start time (n=0 to 359999 seconds) of the currently selected window.

Example: Command: WSTART=36000
Response: (none)

The WSTART command without an operand returns the current setting.

Example: Command: WSTART
Response: WSTART=240

WEND=n This command sets the window end time (n=0 to 359999 seconds) of the currently selected window.

Example: Command: WEND=60
Response: (none)

The WEND command without an operand returns the current setting.

Example: Command: WEND
Response: WEND=240

UPLOAD The unit responds to this command with the current program settings, one line at a time. The UPLOAD command must be sent for each line in the program until NOTE=END is received from the unit. Settings are in the form of commands allowing them to be sent back to the unit to restore a program. All settings are sent, even if they are not relevant to the way the program is currently set.

Example: Command: UPLOAD
Response: PROGRAM=1
Command: UPLOAD
Response: DELAY=0

UPLOAD=n This command chooses which program line (n=0 to 71) is to be sent next.

Example: Command: UPLOAD=0
Response: (none)

UPLOAD=-1 This command responds with the command strings for the entire current program immediately.

Example: Command: UPLOAD=-1
Response: NOTE=PROGRAM 3PTYPE=4
LAST=144PATTERN=1
FTYPE=1FSIZE=1
DELAY=0RANGE=1
THRESHOLD=0
WIDTH=11NONPEAK=3
RESTART=2
WINDOW=1; WSTART=0;
WEND=60WINDOW=2;
WSTART=120;WEND=240
NOTE=Config: Pump off=0, Only
rack=11NOTE=Pattern=3, Peak
det. =5, Motor=5NOTE=Cal:
0mV=32768,
1V=58982,NOTE=100mV=58982,
10mV=35389,NOTE=Time=749,
VREF=500,
Bklash=0NOTE=FLLR=128,
FLFB=128,
FRLR=128NOTE=FRFB=128,
BLLR=128,
BLFB=128NOTE=END

Unsupported Programming Commands

The following serial commands are not supported by the fraction collector.

- ESTATE=n
- ETIME=n
- ETYPE=n
- EVENT=n
- LIST
- PTYPE

These commands were available for earlier fraction collector models. Do not use them with the Foxy R1 and R2 fraction collectors.

4.5.4 Problem Responses

The fraction collector will respond with a PROBLEM=<type> message should the command fail. The following types may be reported.

IMPROPER MODE The program values cannot be changed while a run is in progress.

<input checked="" type="checkbox"/> Note

RUN and STOP cannot be executed while in manual control.

INVALID COMMAND One of three situations could cause this response:

- An unknown command has been entered, usually a typographical error.
- An operand has been sent for a command that does not require one.
- An operand is missing for a command that requires one.

INVALID OPERAND The operand value is out of range or unsupported.

LOCAL MODE The unit must be in the remote mode to do anything other than read values.

Foxy[®] R1 and Foxy[®] R2 Fraction Collectors

Section 5 Maintenance

5.1 Introduction

The fraction collector is designed for years of use in typical laboratory applications. The recommended maintenance tasks primarily address the fluid path, drains, and the fraction collector exterior. These tasks should be performed as needed to ensure the optimum performance of items such as the diverter valve and drop counter, as well as protect the exterior finish. Its mechanical parts do not require periodic adjustment or lubrication.

The fraction collector does not contain user-serviceable parts. Should your instrument require service, refer to section 5.3 for assistance.

5.2 Maintenance

Perform the following tasks as necessary:

- Tubing Inspection, section 5.2.1
- Rack and Drip Tray Cleaning, section 5.2.2
- General Cleaning, section 5.2.3
- Fluid Path Cleaning, 5.2.4
- Drop Counter Cleaning, 5.2.5

 **WARNING**

If collecting fluids that can produce flammable vapors, perform the Tubing Inspection (5.2.1), and the Rack and Drip Tray Cleaning (5.2.2) at least monthly.

5.2.1 Tubing Inspection

 **WARNING**

Risk of fire or equipment damage. Faulty tubing, fittings, and drains may allow organic solvents to pool in unsafe areas, creating a potential for dangerous levels of flammable vapors. Improper draining may damage the instrument's internal components.

If the fraction collector is used with solvents that produce flammable vapors, perform a tubing inspection monthly:

1. Visually inspect the diverter valve inlet and waste lines. The tubing must be free of any damage, kinks, or deterioration. Fittings should show no signs of leaks.
2. Visually inspect the drip tray drain tubing. The tubing should be free of any damage, kinks, deterioration, or obstructions.

Correct any deficiencies before returning the instrument to operation.

5.2.2 Collection Rack and Drip Tray Cleaning

 **WARNING**

Risk of fire or equipment damage. Dirty collection racks and drip tray might inhibit their conductive properties. The racks and tray must be kept clean to dissipate static electricity.

Collection tube racks and drip tray should be kept clean so that they dissipate static electricity. Dirt, film, or coatings might prevent their ability to dissipate static electricity. To avoid problems that possibly result from an electrostatic discharge, clean the racks and tray monthly. Use distilled water with a mild detergent. For tougher stains, use isopropyl alcohol.

The drip tray can be removed for thorough cleaning. It is held in place by pins. First remove the collection racks and any drain tubes. Pry the corners of the drip tray loose with your fingers. After loosening all four corners, lift the drip tray up and off of the instrument case. Clean the drip tray with mild detergent.

To replace the drip tray, place the tray on the instrument, aligning the drain with its hole. Press down on the tray firmly to seat it onto the pins.

5.2.3 Exterior Cleaning

To clean the exterior surfaces, use a cleaning cloth dampened with a mixture of distilled water and a mild detergent. Use isopropyl alcohol for tougher stains.

On printed areas such as labels, avoid rubbing vigorously or using aggressive solvents like acetone. Each will ruin the printed text.

Quickly clean up any aggressive solvents spilled on the exterior surfaces. The paint protects the underlying metal from corrosion. Aggressive solvents might also damage the plastic covers which protect internal components.

 **CAUTION**

Do not immerse the instrument in a water bath or subject it to a liquid spray. The instrument is not watertight and these actions could damage the internal electronics.

5.2.4 Fluid Path Cleaning

Precipitates, crystals, oils, *etc.*, can degrade the performance of the fluid lines, as well as the fraction collector's diverter valve and drop counter operation. If you experience problems with the fluid path or the diverter valve outlet, flush the fluid path with miscible solvent or buffer.

Difficult obstructions may require stronger solvents or buffers as a cleaning fluid. Consider allowing the cleaning fluid to remain in the fluid path overnight.

If problems occur frequently, consider pumping a cleaning fluid through the path as final step in each collection routine.

5.2.5 Drop Counter Cleaning The drop counter is a photosensor device at the outlet of the standard flow rate diverter valve. This device uses a glass sleeve to protect the electronic components. If the performance of the drop counter degrades, the glass sleeve should be cleaned.

To clean the glass sleeve:

1. Place the fraction collector in Standby and remove the AC mains power cord.
2. Remove the collection racks.
3. Carefully unscrew the black retaining ring located under the diverter valve. The glass sleeve rests inside the retaining ring.

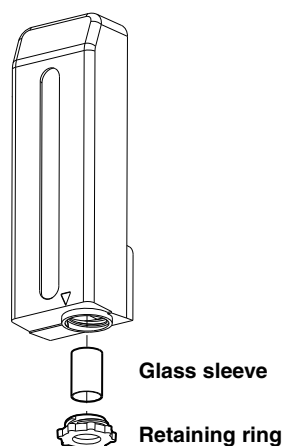

Figure 5-1 Retaining ring for the drop counter's glass sleeve

4. Clean the glass sleeve with a mixture of distilled water and a mild detergent. Use isopropyl alcohol for tougher stains. Alternatively, the tube can be placed in an ultrasonic bath.

CAUTION

Use care to avoid scratching or otherwise damaging the glass tube.

5. Place the cleaned glass sleeve back into the retaining ring and thread the ring back into the diverter valve.
6. Replace the collection racks, connect the AC mains power cord, and return the fraction collector to operation.

CAUTION

Operating the fraction collector without the glass sleeve may damage electronic components inside the diverter valve assembly. Never operate the fraction collector without the glass sleeve.

5.3 Service

 **WARNING**

Risk of serious personal injury or equipment damage. The fraction collector does not contain user-serviceable parts. Service panels and cover should only be removed by trained personnel.

Service problems often can be resolved by telephone or E-mail. US customers can receive support by contacting the factory Technical Service department. Contact information can be found on the Foreword and Warranty pages at the front and back of this manual. If you contact the factory by E-mail, please include the serial number and all relevant information regarding the difficulty you are experiencing with the instrument.

Customers outside of the US should contact their Teledyne Isco dealer for service support. Customers can find their regional dealer by visiting the Teledyne Isco Web site:

<http://www.isco.com/lccontact>

5.4 Instrument Returns

Please contact the Service Department before returning the instrument to the factory for repair. Return instructions can be found on the Foreword and Warranty pages at the front and back of this manual.

5.4.1 How to Ship Returns

Before packing the instrument, make sure all parts and hardware are in their proper places. Wrap the instrument in heavy paper or put it in a plastic bag for extra protection. If at all possible, pack the instrument in its original shipping container with the original packing material. If the original shipping container is not available, place the instrument in a strong cardboard box at least six inches larger in all three dimensions than the instrument itself. Fill the box equally around the instrument with a resilient packing material, such as shredded paper, bubble pack, expanded foam, *etc.* Seal the box with strapping tape or other suitable shipping tape and ship it to the return address listed on the warranty page. The warranty page describes the conditions under which Teledyne Isco will pay surface shipping costs for returns.

It is very important that the instrument be well-packaged for shipment and fully insured. Damage claims must be conducted between you and the carrier. Damage in shipment due to inadequate packing can delay the repair and return of the instrument to you.

Foxy[®] R1 and Foxy[®] R2 Fraction Collectors

Appendix A Icon Glossary and Menu Charts

A.1 Touch Screen Icon Glossary

Table A-1 describes the fraction collector display icons.



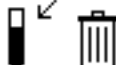





Table A-1 Touch screen display icons	
Icon	Description
	Select the Configuration Tools icon to configure the collection racks, communication settings, and injection overlay settings.
	Select the Folder icon to open a screen from which you can view or modify the current selection.
	Touch the Diverter Valve Position icons to control the position of the diverter valve. When the arrow points to the tube the valve is set to collect fluids in tubes. When the arrow points to the waste can the valve is set to route fluids to waste.
$\frac{NNN}{MAX}$	This region of the display reports the current tube position on the top line. The bottom line reports the maximum number of tubes held by the rack or a user specified number of tubes (see page 3-4).
	Touch the Next Tube icon to advance the drop former to the next tube position.
	Touch the Play icon from the main menu to start operation.
	Touch the Pause icon during operation to suspend tube advances. While paused, the Pump Pause output signal is active to disable an external pump.
	Touch the Stop icon to halt operation. The drop former will return to the home position.
	Touch the Standby/On icon to toggle the fraction collector between these modes.
	Touch the Enter icon to accept the current settings and return to the previous screen.









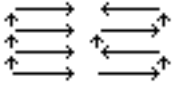

Table A-1 Touch screen display icons (Continued)	
Icon	Description
	Touch the Rack icon to open a screen from which you can select the rack type and collection pattern, and calibrate the drop former position.
	The Tube Advance Speed icon allows you to access a screen from which you can set the speed of the tube advance motion. From the tube advance speed screen, touch this icon to speed up the movement.
	Touch the Slow icon to slow the tube change movement.
	This icon indicates the tube advance speed setting. The speed setting ranges from 1 (slowest) to 5 (fastest).
	Touch the Calibrate icon to open a screen from which you can adjust the drop former position.
	When calibrating the arm, touch the First Tube Position icon to move the drop former over the first tube. The drop former will move to the first tube position for the current rack configuration.
	When calibrating the arm, touch the Last Tube Position icon to move the drop former over the last tube. The drop former will move to the last tube position for the current rack configuration. On two rack fraction collectors the last tube position is on the second rack.
	The Arrow icons perform several functions. In some screens, the up and down arrows increment and decrement alphanumeric values. In other screens, the arrows move the cursor position. In the calibrate mode, the arrow icons finely calibrate the drop former position.
	Touch the Collection Pattern icon to toggle between left-to-right and serpentine patterns.
	Touch the Maximum Tube Number icon to specify the last tube in a rack. The default value is the maximum capacity of the selected rack. Users can specify a lesser value if the rack is not filled completely with empty tubes, or to end the run sooner.
	Touch the Serial Port icon to open a screen from which you can configure the serial communication settings.

Table A-1 Touch screen display icons (Continued)









Icon	Description
	<p>Touch the Ethernet Port icon to open a screen from which you can configure TCP/IP communication settings and view the MAC address.</p>
	<p>Touch the Inject icon to open a screen from which you can select the restart action for each injection.</p> <p>Restarts can be initiated by a user-specified Time or an Inject signal from an external device. When using one of the Inject options, the fraction collector waits for the first restart event before starting the method. The touch screen Play icon will alternate with the Inject icon while waiting. After the injection, touch the Play icon to continue with the method. Timed restarts occur without intervention.</p> <p>When a restart occurs, the collection pattern can return to the first tube of the previous run to Overlay multiple fractions from a repeated sample. Alternatively, a restart can start at the Next tube, or Skip a tube to separate the runs.</p>
	<p>Touch the Pump Control icon to access the settings to control the output at pin 2 of the Pump connector. This signal can be used to pause the pump operation during tube advances.</p>
	<p>The icon with the "1" (left) indicates that the fraction collector will not send a pause signal from pin 2. In this state, the external pump will continue to operate during tube changes. The icon with the "0" indicates that the fraction collector will send a pause signal from pin 2.</p>
	<p>Touch the Analog Peak setting icon to view a list of voltage ranges for the peak input. When using this feature, set the analog peak voltage scale to the range of the detector signal.</p>
	<p>Touch the Information icon to display Model number and hardware/firmware revisions.</p>
	<p>Touch the Drop icon to collect fractions based on the number of drops collected. Touching this icon opens a screen from which you can set the delay volume (as a number of drops) and the number of drops to collect before performing a tube advance. If selected, the display shows a border around this icon.</p>
	<p>Touch the Time icon to collect fractions based on time. Touching this icon opens a screen from which you can set the delay volume (as a time interval) and the time duration of each fraction. If selected, the display shows a border around this icon.</p>





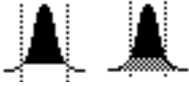









Table A-1 Touch screen display icons (Continued)	
Icon	Description
	Touch the Volume icon to collect fractions based on an external pump volume count. Touching this icon opens a screen from which you can set the fraction and delay volumes as a number of pump counts. If selected, the display shows a border around this icon.
	Each touch of the Volume Select icon toggles between volume setting modes. The current selection is indicated by the surrounding border. When the hourglass (left) is selected, enter the delay volume. When the tube (right) is selected, enter the fraction size. The units for each setting reflect the selected Time, Drop, or Volume, fraction collection mode.
	Touch the Threshold Peak Detection icon to configure the threshold settings. A border around this icon indicates that threshold peak detection is enabled. When editing the threshold settings, touch this icon to toggle between collection modes. The left icon indicates that only peak fluids will be collected; non-peak fluids are diverted to waste. The right icon indicates that peak and nonpeak fluids will be collected. Threshold detection monitors the percentage of an analog input signal. The threshold condition is true when the input signal exceeds a user-set value. However, the peak state may or may not be true depending on the Threshold Detection Options.
	Touch the Threshold Detection Options icons to select a detection mode. The top icon indicates that threshold peak detection is OFF. The middle Union icon indicates that threshold peak detection is enabled. If the value is exceeded, the peak state will be true regardless of any other detection mode (a logical OR). The bottom Intersection icon indicates that peak detection is enabled. If the value is exceeded, the peak state is true only when other enabled detection conditions are met (a logical AND).
	Touch the Peak Width Detection icon to configure the peak width settings. A border around this icon indicates that peak width detection is enabled. When editing the peak width settings touch the icon to toggle between collection modes. The left icon indicates that only peak fluids will be collected; non-peak fluids are diverted to waste. The right icon indicates that peak and nonpeak fluids will be collected. In this mode, the system uses a user-specified peak width value and an algorithm to determine a range of possible input signal slopes. A peak width condition is true when the analog input signal rises at a rate within this range. However, the peak state may or may not be true depending on the Peak Width Detection Options.

Table A-1 Touch screen display icons (Continued)

Icon	Description
	<p>Touch the Peak Width Detection Options icons to toggle through the detection modes. The top icon indicates that peak width detection is OFF. The middle Union icon indicates that peak width detection is enabled. If the slope of the input signal indicates a peak, the peak state will be true regardless of any other detection mode (a logical OR). The bottom Intersection icon indicates that peak width detection is enabled. If the slope of the input signal indicates a peak, the peak state is true only when other enabled detection conditions are met (a logical AND).</p>
	<p>Touch the Time Windows icon to collect fluids within a time window. A border around this icon indicates that at least one time window is programmed and enabled.</p>
	<p>Touch the Time Window Options icons to toggle modes. The left icon indicates that the Time Windows mode is OFF. The right Intersection icon indicates that a time window is enabled. If a threshold or peak width detection condition is true, and the time window condition is true, the peak state is also true (a logical AND).</p>
<p style="text-align: center;">Start End</p> <p>1 </p> <p>2 </p> <p>3 </p> <p>4 </p>	<p>Each touch of the Time Windows Start/Stop icon advances through the available windows.</p> <p>To advance to the next Time Window, the current window's settings must have different start and end values. (Matching values indicates that the previous window is the final time window.)</p> <p>Start and end times are relative to the time you press the Run button to start operation.</p>
	<p>The Computer icon indicates that a remote device is connected to the fraction collector. When under remote control, all run-time controls may also be accessed from the touch screen display. However, programming and configuration settings cannot be modified.</p> <p>Touch this icon to terminate the remote connection and operate the fraction collector from the touch screen display. This will return you to the main menu from which you can also access the configuration and programming menus.</p>
	<p>The Lock icon indicates that a remote device has exclusive control of the fraction collector. You must operate the fraction collector from the host device.</p>

**A.2 Touch Screen Menu
 Flow Charts**

Figures A-1 through A-4 illustrate the fraction collector menus.

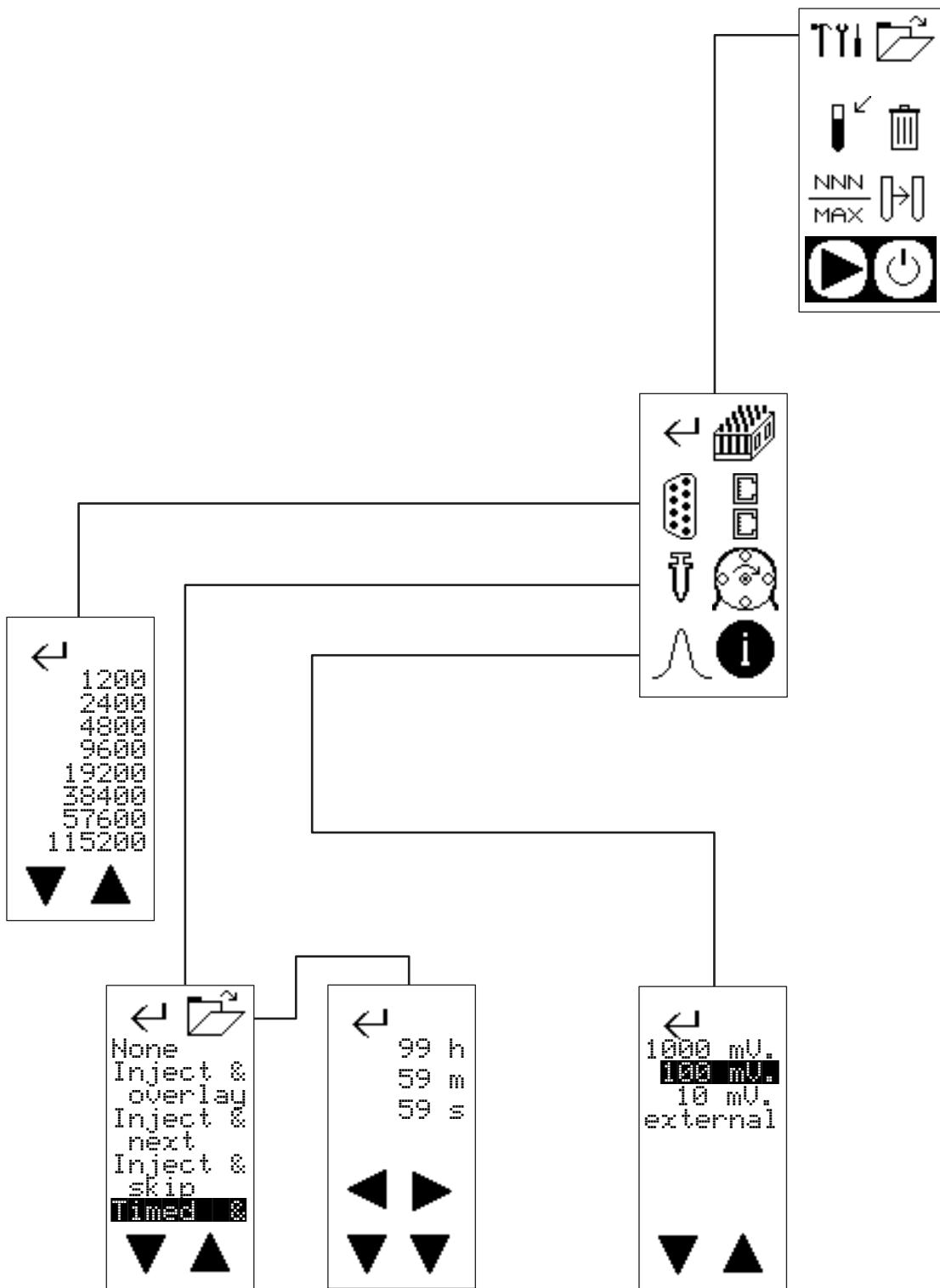

Figure A-1 Configuration settings

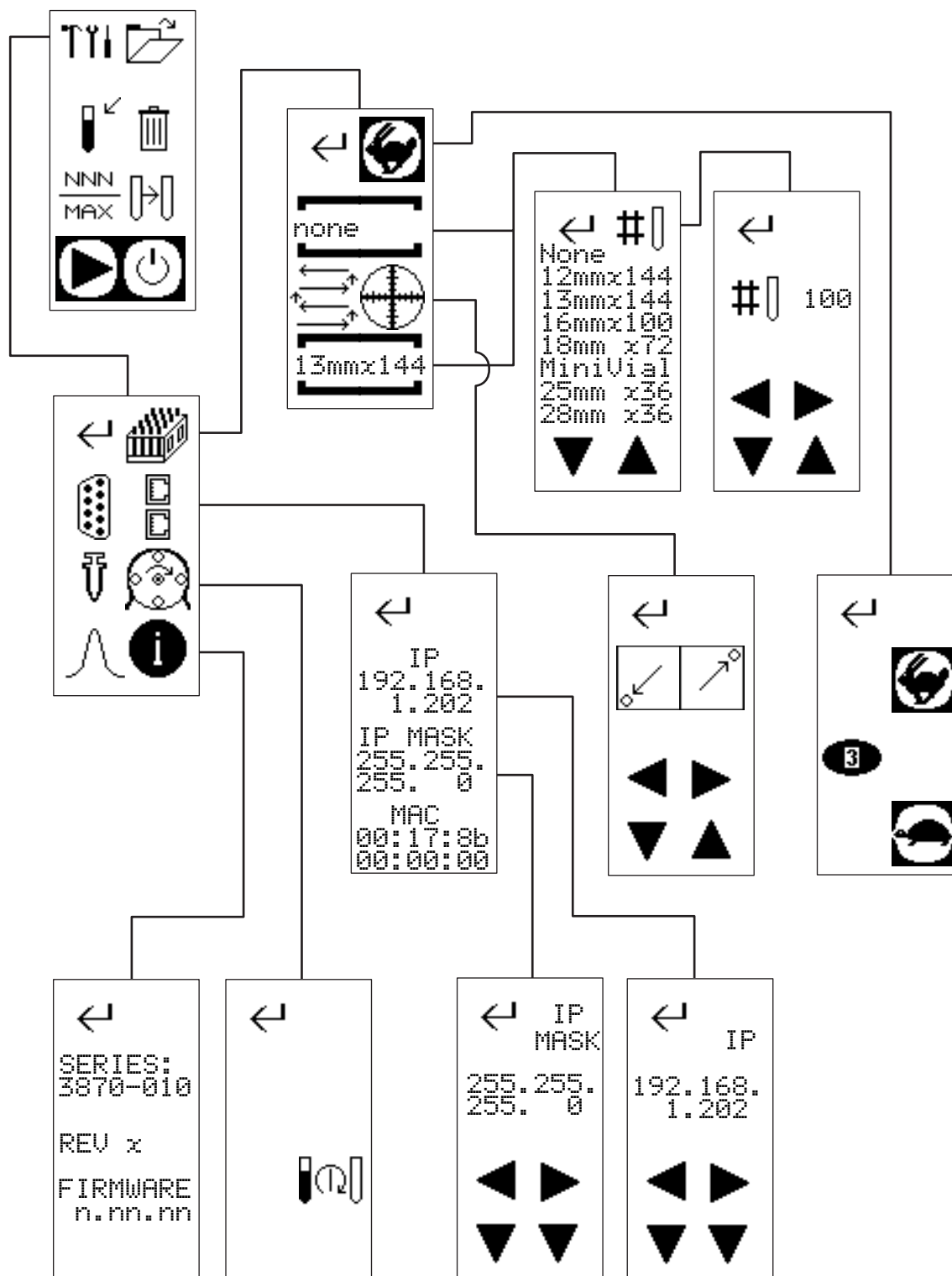

Figure A-2 Configuration settings, continued

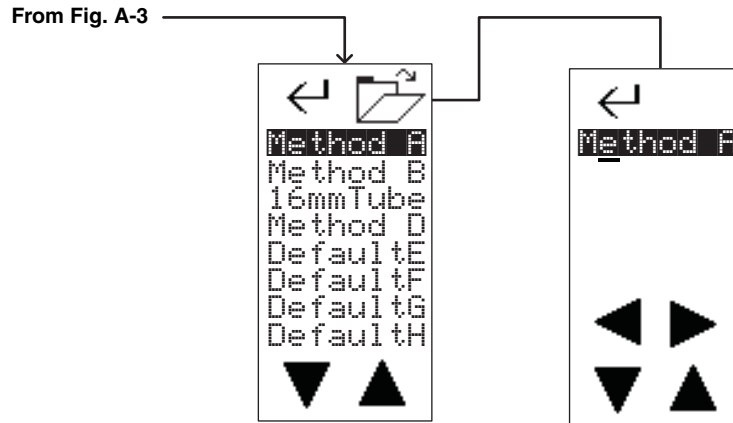

Figure A-4 Saved method recall and method name editing

Foxy[®] R1 and Foxy[®] R2 Fraction Collectors

Index

A

- AC power cord, 2-2
- addresses, IP and MAC, 3-6
- AND, combined peak detection, 3-16, 3-18, **3-19**
- applications, typical, 1-7

C

- cables
 - CAT5, 4-1
 - Isco detector, 1-10
 - Isco pump, 1-10
 - non-Isco detector, 1-11
 - non-Isco pump, 1-10
- calibration, drop former position, 3-5
- CAT5 cable, 4-1
- checklist, installation qualification (IQ), 2-13
- claims, damage, 2-1, 5-4
- cleaning
 - drip tray and racks, 5-2
 - drop counter, 5-3
 - exterior, 5-2
 - fluid path, 5-2
- collection rack
 - cleaning, 5-2
 - grounding, 2-11
 - installation, 2-10
 - part numbers, 1-3
- collection tube pattern, 3-4
- collection tube volumes
 - by drop counts, 3-12
 - by pump counts, 3-14
 - by time intervals, 3-13
- commands, serial
 - immediate control, 4-6
 - miscellaneous, 4-2
 - problem responses, 4-17
 - programming, 4-9
 - syntax, 4-2
- communications
 - ethernet, 4-1
 - RS232 serial, 4-1
- configuration settings, 3-3
- connections
 - diverter valve, 2-5, 2-7
 - drip tray drain tubing, 2-9
 - electrical, 1-8 to 1-11
 - fluid, 2-5

connectors

- AC mains power, 1-8
- detector, 1-9
- ethernet, 1-8
- pump, 1-9
- rear panel diagram, 1-8
- serial (RS232), 1-10

D

- damage claims, 2-1, 5-4
- delay volume
 - calculating, 3-12
 - compensation, 1-6
- detector cable
 - Isco, 1-10
 - non-Isco, 1-11
 - rear panel connector, 1-9
- dimensions, physical, 1-6
- diverter valve
 - fluid connections, 2-5, 2-7
 - height adjustment, 2-2, **2-12**
- drip tray
 - cleaning, 5-2
 - drain tubing connection, 2-9
 - removal, 5-2
- drop counter
 - cleaning, 5-3
 - glass sleeve, 5-3
- drop counting
 - general, 1-2
 - settings, 3-11
- drop former calibration, 3-5

E

- error messages, 4-17
- ethernet
 - communications, 4-1
 - rear panel connector, 1-8
 - settings, 3-6
- external peak detection, 3-9

F

- factory service, 5-4
- features, 1-4
- ferrules, 2-6, 2-8
- firmware version, 3-9
- fittings, swaged, 2-6, 2-8
- flow delay, when using pump counts, 3-15

flow delays, 3-12
flow rate, maximum, 1-6
fluid path cleaning, 5-2
fluids, collect or divert, 3-16, 3-18
funnel racks, 1-4

G

glass sleeve, 5-3

H

hardware version, 3-9
high flow valve, 1-1, 1-6
 connections, 2-7
 height adjust, 2-2
 no drop counting, 1-2

I

illustrated parts breakdown, B-1
injection options, 3-6
input signals
 connector pins, 1-8 to 1-11
 peak options, 1-2
 peak voltage setting, 3-9
 specifications, 1-7
inspection
 preliminary, 2-1
 rack grounding, 2-11
 tubing, 5-1
installation qualification (IQ) checklist, 2-13
intersection (Venn diagram symbol), 3-19
IP address and mask, 3-6

L

LabVIEW, 4-1
level adjustment foot, 1-4
local mode, 3-1, 4-2, **4-4**
logical operators (AND, OR), 3-16, 3-18, **3-19**
lubrication, not required, 5-1

M

main menu, 2-2, **3-2**
mains power cord, 2-2
materials, wetted, 1-7
menus
 configuration, 3-3
 drop counting, 3-11
 main, 2-2, **3-2**
 method editing, 2-4
 method selection, 3-10
 method settings, 3-10
 rack settings, 3-3
 renaming a method, 3-11
 threshold peak detection, 3-16
 time intervals, 3-13
 time windows, 3-21
 time-based fractions, 2-4
 volume (pump count) settings, 3-14

method

 selection menu, 2-3, **3-10**
 settings, 3-10

mode

 computer icon, 3-1
 local, 4-4
 remote, 4-2, **4-4**

N

next tube option, injection or timed restarts, 3-9

O

OR, combined peak detection, 3-16, 3-18, **3-19**
output signals
 connector pins, 1-8 to 1-11
 pump control setting, 3-9
 specifications, 1-7
overlay tubes option, injection or timed restarts,
 3-8

P

packing, 5-4
parts, replacement, B-1
pattern, collection tube, 3-4
peak and waste fluids, 3-16, 3-18
peak detection
 combining threshold and peak width, 3-16,
 3-18, **3-19**
 external detector, 3-9
 peak width (slope), 3-17
 threshold, 3-15
peak input signal
 specifications, 1-2
peak width (slope) detection
 general, 1-2
 ranges, 3-18
 settings, 3-17
physical dimensions, 1-6
power cord, 2-2
preliminary checkout, 2-1
pump cable
 Isco, 1-10
 non-Isco, 1-10
 rear panel connector, 1-9
pump control output settings, 3-9
pump count settings, 3-14

R

rack
 cleaning, 5-2
 configuration settings, 3-3
 grounding, 2-11
 installation, 2-10
 part numbers, 1-3
 RFID detection (Foxy R2), 2-10
 specify last tube, 3-4
remote mode, 3-1, 4-2, **4-4**

renaming a method, 3-11
replacement parts, B-1
restarts, 3-6
returns, 5-4
RFID, 2-10
 defined, 1-1
 racks and funnels, 1-4
RS232 serial
 communications, 4-1
 connector, 1-10
 settings, 3-5

S

serial (RS232)
 communication settings, 3-5
 communications, 4-1
 connector, 1-10
serial commands
 immediate control, 4-6
 miscellaneous, 4-2
 problem responses, 4-17
 programming, 4-9
 syntax, 4-2
service, 5-4
shipping, 5-4
skip tube option, injection or timed restarts, 3-9
slope detection - see *peak width detection*
specifications, 1-6
speed, tube advance, 3-4
swaged fittings, 2-6, 2-8
syntax, serial commands, 4-2
system control options, 1-7

T

TCP/IP settings, 3-6
telnet, 4-1
temperature, operating, 1-7
threshold detection
 general, 1-2
 settings, 3-15
time intervals
 general, 1-2
 settings, 3-13
time windows
 general, 1-2
 menu, 3-21
 settings, 3-20
timed restarts, 3-6
tools, configuration, 3-3
tube advance speed, 3-4
tube height, maximum, 1-6
tube volumes
 by drop counts, 3-12
 by pump counts, 3-14
 by time intervals, 3-13
tube, set maximum, 3-4
tubing inspection, 5-1

U

union (Venn diagram symbol), 3-19
unpacking, 2-1

V

Venn diagrams, 3-16, 3-18, **3-19**
volume (pump count)
 general, 1-2
 settings, 3-14
volumes
 by drop counts, 3-12
 by pump counts, 3-14
 by time intervals, 3-13

W

warranty service, 5-4
waste and peak fluids, 3-16, 3-18
weight, 1-6
wetted materials, 1-7
windows, time, 3-20

DECLARATION OF CONFORMITY



Application of Council Directive: 2014/30/EU -The EMC Directive
 2002/96/EC – The WEEE Directive
 2014/35/EU – The Low Voltage Directive

Manufacturer's Name: Teledyne Isco
 Manufacturer's Address: 4700 Superior
 Lincoln, Nebraska 68504-1398 USA
 P.O. Box 82531, Lincoln, NE 68501-2531
 Phone: +1 (402) 464-0231
 Facsimile: +1 (402) 465-3799

Equipment Type/Environment: Laboratory Equipment for Light Industrial/Commercial Environments

Trade Name/Model No: Foxy R1, R2
 Year of Issue: 2016

Standards to which Conformity is Declared: EN 61010-1 3rd edition Safety Requirements for Electrical Equipment for Measurement, Control, and Laboratory Use
 EN 61326-1:2013 EMC Requirements for Electrical Equipment for Measurement, Control, and Laboratory Use

Standard	Description	Severity Applied	Performance Criteria
EN61000-3-2:2014	Current Frequency Harmonics	Class A	PASS
EN61000-3-3:2013	Voltage Fluctuations and Flicker	Class A	PASS
EN61000-4-2	Electrostatic Discharge	Level 2 - 4kV contact discharge Level 3 - 8kV air discharge	A
EN61000-4-3	Radiated RF Immunity	80 MHz to 1000MHz 80% AM at 1kHz Level 2 - 3V/m	A
EN61000-4-4	Electrical Fast Transient	Level 2 - 1kV on AC lines	A
EN61000-4-5	Surge on AC Lines	Level 2 - 1kV common mode, Level 2 - 0.5KV differential mode	A
EN61000-4-6	Conducted RF on AC lines	150 kHz to 80 MHz, Level 1 - 1V rms, 80% modulated	A
EN61000-4-11	Voltage Dips/Interruptions	100% drop, 10ms	A
CISPR11/ EN 55011	RF Emissions	Group 1, Class A Industrial, Scientific, and Medical Equipment	

The undersigned, hereby declares that the design of the equipment specified above conforms to the above Directive(s) and Standards as of May 31, 2016.

USA Representative

Edward J. Carter
 Director of Engineering



60-2132-663
 Rev B

产品中有毒有害物质或元素的名称及含量

Name and amount of Hazardous Substances or Elements in the product

部件名称 Component Name	有毒有害物质或元素 Hazardous Substances or Elements					
	铅 (Pb)	汞 (Hg)	镉 (Cd)	六价铬 (Cr(VI))	多溴联苯 (PBB)	多溴二联苯 (PBDE)
线路板 Circuit Board	O	O	O	O	O	O
液晶显示 LCD Display	O	O	O	O	O	O
接线 Wiring	O	O	O	O	O	O
内部电缆 Internal Cables	O	O	O	O	O	O
主电源线 Line Cord	O	O	O	O	O	O
变压器 Transformer	O	O	O	O	O	O
直流电机 DC Motor	O	O	O	O	O	O
小键盘 Keypad	O	O	O	O	O	O

产品中有毒有害物质或元素的名称及含量：Name and amount of Hazardous Substances or Elements in the product

O: 表示该有毒有害物质在该部件所有均质材料中的含量均在ST/ 标准规定的限量要求以下。

O: Represent the concentration of the hazardous substance in this component's any homogeneous pieces is lower than the ST/ standard limitation.

X：表示该有毒有害物质至少在该部件的某一均质材料中的含量超出ST/ 标准规定的限量要求。

(企业可在此处，根据实际情况对上表中打“X”的技术原因进行进一步说明。)

X: Represent the concentration of the hazardous substance in this component's at least one homogeneous piece is higher than the ST/ standard limitation.

(Manufacturer may give technical reasons to the "X"marks)

环保使用期由经验确定。

The Environmentally Friendly Use Period (EFUP) was determined through experience.

生产日期被编码在系列号码中。前三位数字为生产年(207 代表2007年)。随后的一个字母代表月份：A 为一月，B为二月，等等。

The date of Manufacture is in code within the serial number. The first three numbers are the year of manufacture (207 is year 2007) followed by a letter for the month. "A" is January, "B" is February and so on.

FOR WARRANTY: Please consult our website at www.teledyneisco.com to download a digital copy of the Warranty for your Foxy Fraction Collector.

Before returning any instrument for repair, please call, fax, or e-mail the Teledyne Isco Service Department for instructions. Many problems can often be diagnosed and corrected over the phone, or by e-mail, without returning the instrument to the factory.

Instruments needing factory repair should be packed carefully, and shipped to the attention of the service department. Small, non-fragile items can be sent by insured parcel post. **PLEASE BE SURE TO ENCLOSE A NOTE EXPLAINING THE PROBLEM.**

Shipping Address: Teledyne Isco - Attention Repair
Service 4700 Superior Street
Lincoln, NE 68504 USA

Mailing Address: Teledyne Isco
PO Box 82531 Lincoln,
NE 68501 USA

Phone: Repair (800) 775-2965 (lab instruments)
service: (866) 298-6174 (samplers & flow
meters)

Fax: Sales & General Information: (800) 228-4373 (USA &
Canada) (402) 465-3001

Email: IscoService@teledyne.com



