

Smartline

▶ Detector 2550 User Manual

V5193A



Table of Contents

Note For your own safety, **read** the manual and **always** observe the warnings and safety information on the device and in the user manual.

Intended Use	6
Local network and automatic configuration	6
Operating range	6
Where is use of the device prohibited?	7
Features	7
Eluents	8
Safety	9
Definition of Personal and Material Damage	11
Decontamination	11
Symbols and Signs	12
Unpacking and Setup	13
Contacting the Technical Support	13
Location Requirements	13
Ventilation	13
Space Requirements	13
Power Supply and Connection	14
Power Cable	14
Power Plug	14
Packaging and transport	14
Remove fastening material	14
Protective film on the display	14
Scope of supply	15
Checking the scope of supply	15
Device overview	16
Front view of the device	16
Device door with input field and display	16
Front view of the device with door open	16
Overview of the basic buttons	17
Rear view of the device	18
Startup	19
Checklist before initial operation	19
Installation of the flow cell	19
Installing the flow cell	20
Changing the path length of a preparative flow cell	20
Connecting the detector to other devices	22

Electrical connections	22
Connecting the connector strip with the cable	22
Terminal strip Event and remote control on the rear of the device	23
Manual configuration of the control signals (events)	25
Control of the detector with chromatography software	26
Connecting a Device in a Local Area Network (LAN) to a Computer	26
Controlling the detector	31
Switching the detector on	31
Selecting the wavelength	32
Options for signal output	32
Controlling the main menu	33
Selecting the Setup menu	33
Selecting the GLP menu	34
Selecting the Link menu	34
Selecting the Program menu	34
Controlling the Setup menu	34
Structure of the Setup menu	35
Parameters of the Setup menu	36
Controlling the GLP menu	40
Structure of the GLP menu	40
Parameters of the GLP menu	42
Controlling the Program menu	43
Creating a program	43
Running a program	44
Changing a program	45
Deleting a program	46
Creating a program with preselectable start time	47
Controlling the Link menu	48
Creating a link	48
Executing a link	49
Deleting a link	51
Controlling the Scan menu	51
Performing wavelength scans	52
Maintenance and care	53
Contacting the Technical Support	53
Maintenance Contract	53
Cleaning and Caring for the Device	54
Cleaning the flow cell	54
Flushing the flow cell	54
Cleaning the lens of an analytical flow cell	54
Cleaning the fiber optics of a preparative flow cell	55
Replacing the flow cell	57
Disposal	58

Storage	58
Troubleshooting	59
System messages	59
Technical data	63
Accessories and Spare Parts	65
Available flow cells for the Smartline detector 2550	66
Analytical flow cells	66
Preparative flow cells	67
U-Z View™ flow cells	68
Flow cell replacement parts	68
Test Cells	69
Legal Information	70
Warranty Conditions	70
Transportation Damages	70
Abbreviations and terminology	71
Declaration of Conformity	72
Table of Figures	73
Index	74

To whom it may concern In case you prefer a French language user manual for this product, submit your request including the corresponding serial number via email or fax to KNAUER:

- support@knauer.net
- +49 30 8015010

Thank you.

A qui que ce soit Si jamais vous préféreriez un manuel en français pour ce produit contacter KNAUER par email ou par fax avec le no. de série:

- support@knauer.net
- +49 30 8015010

Merci beaucoup.

Intended Use

HPLC High performance liquid chromatography (HPLC) is a method for separating compounds, determining substances and measuring their concentration. The UV detector is the most frequently used detector in HPLC.

Smartline UV detector 2550



The Smartline UV detector 2550 is a measuring system for fast and precise measurement of UV spectra and optionally with a halogen lamp for the visual spectrum. The measurement principle is based on the attenuation of a monochromatic light beam passing through liquid.

The self-calibration of the detector guarantees operation without external settings. Type and combination of the installed lamps as well as the transmission of the corresponding installed flow cell are analyzed and used for the automatic setting of the integration time, in order to achieve a high level of sensitivity.

Note: This manual applies for the Smartline UV detector 2550 as well as for the UV-Vis detector 2550.

Checking intended use Use the device only for applications that fall within the range of the intended use. Otherwise, the protective and safety equipment of the device could fail.

Local network and automatic configuration

The detector is controlled either by means of the input field on the front of the device, or by means of the chromatography software.

Remote control Normally, the detector is controlled by the chromatography software through a local network (LAN).

Automatic configuration The detector connected to the local area network (LAN) is automatically detected by the chromatography software.

Device status When used in a local area network (LAN), the system status of the detector can be checked using the chromatography software.

LAN setting The detector is set to DHCP (Dynamic Host Configuration Protocol) at the factory. This means that the detector is automatically assigned an IP address within the local network. In the Setup menu, this setting can be modified manually.

Operating range

The detector can be used in analytical and preparative HPLC systems. It is used in laboratories to analyze substance mixtures. In an HPLC system, the detector serves to detect substances in liquids and show their concentration.

The device can be used in the following areas:

- Biochemistry analysis

- Chemical analysis
- Food analysis
- Pharmaceutical analysis
- Environmental analysis

The detector is, e. g., used at universities, research institutions and routine laboratories.

Where is use of the device prohibited?



DANGER! Explosion hazard, if the device is used in potentially explosive atmospheres without appropriate protective equipment! Let specialists carry out protective measures.

Features

- Signal linearity and wavelength accuracy are verified by independent measurements as part of a self-calibration.
- Within a system, it is possible to measure four wavelengths simultaneously with the help of the software control.
- Recording of a spectrum of 100 nm width in less than 100 ms.
- The beam guidance is designed so that no chromatic aberration occurs and thus the best possible useful signal is available, independent of the selected wavelength.
- Automatic recording and storage of the device-specific characteristics that are important for GLP (Good Laboratory Practice) and OQ (Operation Qualification) or are of interest for the device service and device history. These are operating times, operating parameters, wavelength accuracy and reference spectra.
- Self-running and up-to-date device status diagnostics.
- Control with KNAUER HPLC software possible.
- Easy integration of the detector into complex chromatography systems.
- Extremely low noise level and equally low drift.
- High data rates for fast chromatography.
- Flexible options for use in the entire field of LC applications due to a comprehensive range of flow cells for the KNAUER detectors, from nano HPLC cells with flow rates ≈ 100 nl/min to preparative flow cell
- Is with 10 l/min.

Options Various types of flow cells are available to the user. Pay attention to the compatibility of the flow cells.

Note A test cell is preassembled to the detector. Before the detector can be used for measurements the test cell has to be replaced by a flow cell.

Eluents

Even small quantities of other substances, such as additives, modifiers, or salts can influence the durability of the materials.

Note The list of selected solvents was compiled based on research in the pertinent literature and is only a recommendation. If there is any doubt, contact the Technical Support of the manufacturer.

Suitable eluents	Less suitable eluents	Not suitable eluents
<ul style="list-style-type: none"> ▪ Acetone at 4°-25° C (39.2°-77.0° F)¹ ▪ Acetonitrile ▪ Benzene ▪ Chloroform ▪ Ethyl acetate ▪ Ethanol ▪ Hexane/heptane at 4°-25° C (39.2°-77.0° F)¹ ▪ Isopropanol ▪ Carbon dioxide (liquid 99.999% CO₂) ▪ Methanol ▪ Phosphate buffer solutions (0.5 M) ▪ Toluol ▪ Dilute ammonia solution ▪ Dilute acetic acid (10-50%), at 25° C/77.0° F ▪ Dilute sodium hydroxide (1M) ▪ Water 	<ul style="list-style-type: none"> ▪ Dimethyl sulfoxide (DMSO) ▪ Slightly volatile eluents ▪ Methylene chloride ▪ Tetrahydrofuran (THF) ▪ Dilute phosphoric acid 	<ul style="list-style-type: none"> ▪ Halogenated hydrocarbons, e.g. Freon[®] ▪ Concentrated mineral and organic acids ▪ Concentrated bases ▪ Eluents containing particles ▪ Perfluorinated eluents, e. g. Fluorinert[®] FC-75, FC-40 ▪ Perfluorinated polyether, e.g. Fomblin[®]

1. valid for the specified temperature range

Safety

Professional group The user manual is addressed to persons that are qualified as chemical laboratory technicians or have completed comparable vocational training.

The following knowledge is required:

- Fundamental knowledge of liquid chromatography
- Knowledge regarding substances that are suitable only to a limited extent for use in liquid chromatography
- Knowledge regarding the health risks of chemicals
- Participation during an installation of a device or a training by the company KNAUER or an authorized company.

If you do not belong to this or a comparable professional group, you may not perform the work described in this user manual under any circumstances. In this case, please contact your superior.

Safety equipment When working with the device, take measures according to lab regulations and wear protective clothing:

- safety glasses with side protection
- protective gloves
- overall

What must be taken into account?

- All safety instructions in the user manual
- The environmental, installation and connection specifications in the user manual
- National and international regulations pertaining to laboratory work
- Original spare parts, tools, and eluents made or recommended by KNAUER
- Good Laboratory Practice (GLP)
- Accident prevention regulations published by the accident insurance companies for laboratory work
- Filtration of substances under analysis
- Use of inline filters
- Once they have been used, never re-use capillaries in other areas of the HPLC system.
- Only use a given PEEK fitting for one specific port and never re-use it for other ports. Always install new PEEK fittings on each separate port.
- Follow KNAUER or manufacturer's instructions on caring for the columns

More safety-relevant information is listed in alphabetical order in the following table:

Topic	Explanations
Eluent lines	Install capillaries and hoses in such a way that liquids cannot get into the interior in case of a leak.
Flammability	Organic eluents are highly flammable. Since capillaries can detach from their screw fittings and allow eluent to escape, it is prohibited to have any open flames near the analytical system.
Leaks	Regularly check if any system components are leaking.
Power cable	Defective power cables are not to be used to connect the device and the mains power.
Power strip	If several devices are connected to one power strip, always consider the maximum power consumption of each device.
Power supply	Only connect devices to voltage sources, whose voltage equals the device's voltage.
Self-ignition point	Only use eluents that have a self-ignition point higher than 150 °C under normal ambient conditions.
Solvent tray	Risk of electrical shock or short circuit if liquids get into the device's interior. For this reason, place all bottles in a solvent tray.
Toxicity	Organic solvents are toxic above a certain concentration. Ensure that work areas are always well-ventilated! Wear protective gloves and safety glasses when working on the device!

Where is use of the device prohibited?

Never use the system in potentially explosive atmospheres without appropriate protective equipment. For further information, contact the Technical Support of KNAUER.

Take the device out of operation

At any time, take the device completely out of operation by either switching off the power switch or by pulling the power plug.

Opening the module

The device may only be opened by the KNAUER Technical Support or any company authorized by KNAUER.

Definition of Personal and Material Damage

Possible dangers related to the device are distinguished in personal and material damages in this user manual.

Type of damage	Category	Explanations
Personal damages	DANGER!	Lethal or very serious injuries can occur.
	WARNING!	Serious injuries can occur.
Personal and material damage	CAUTION!	Moderate injuries can occur. Device defects can occur.

Decontamination

Contamination of devices with toxic, infectious or radioactive substances poses a hazard for all persons during operation, repair, sale, and disposal of a device.



DANGER!

Danger if getting in contact with toxic, infectious or radio-active substances.







Before disposing off or sending away contaminated devices, commission an expert with the decontamination.

All contaminated devices must be properly decontaminated by a specialist company or the operating company before they can be recommissioned, repaired, sold, or disposed of.

All materials or fluids used for decontamination must be collected separately and disposed of properly.

Symbols and Signs

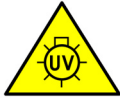
The following symbols and signs can be found on the device, in the chromatography software or in the user manual:

Symbol	Meaning
	High-voltage hazard
	Electric shock hazard
	Electrostatic discharge hazard, damages to system, device, or components can occur.
	General warning sign, moderate injuries can occur and also damages to system, device, or components.
	UV-light hazard, eye injuries can occur.
	Hazardous substances.
	A device or system marked with CE fulfills the product specific requirements of European directives. This is confirmed in a Declaration of Conformity.

Unpacking and Setup

Contacting the Technical Support

You have various options to contact the Technical Support:

Phone +49 30 809727-111

Fax +49 30 8015010

E-mail support@knauer.net

You can make your requests in English and German.

Location Requirements

Requirements The location for the device must meet the following requirements:

- level surface for device or system
- Protect from heavy ventilation
- Weight 6 kg
- Dimension 226 × 135 × 410 mm
(Width × Height × Depth)
- Power supply 100 – 240 V; 50 – 60 Hz; 75 W
- Humidity below 90 %, non condensing
- Temperature range 4 - 40 °C; 39.2 - 104 °F

Ventilation



CAUTION!

**Defect of the device due to overheating possible!
Protect the device against exposure to direct sunlight.**

Make sure the room is well-ventilated.

Keep clear at least 15 cm at rear and 5 – 10 cm at each side for air circulation.

Space Requirements

- Side clearance to other devices:
 - At least 5 cm, if there is another device on one side.
 - At least 10 cm, if there are devices set up on both sides.
- At least 15 cm on the rear panel for the fan.

Power Supply and Connection

The device is intended for use with AC power networks of 100-240 V. The supplied power cable is to be used to connect the device to the mains supply.

Only use power units with a permission for use from your country. In case of queries contact the Technical Support

Power Cable

Only the supplied power cable is to be used to connect the device to the mains supply. Replace defective power cables only with original accessories from KNAUER.

Power Plug

- Note**
- Make sure that the power plug on the rear of the device is always accessible, so that the device can be disconnected from the power supply.

Packaging and transport

At the factory, all KNAUER devices are carefully packed for safe transport.

Checking for signs of damage during transport

Check the device and accessories for signs of damage that occurred during transport. If the shipment is incomplete or damaged, inform the manufacturing factory within three work days. Also inform the freight carrier about transport damage.

Remove fastening material

The device is held in place and protected by foam inserts at the top and bottom. Please keep the transport box and the foam inserts.

Remove fixation material

- Remove the foam insert on the top of the device.
- Remove the transport securing device.

Removing device from packaging.

- Grip the device at its sides near the front and lift it out of the packaging.

Protective film on the display

During transport, a protective film prevents scratches to the screen of the device.

Scope of supply

The delivery consists of:

- Smartline detector 2550 with test cell

Accessories:

- Device manual
- Cables
 - Power cable
 - RS-232 port cable
 - 2 flat ribbon cables, 10-pin
 - LAN network cable (Ethernet patch CAT5e)
 - 2 audio/video connection cables, 2 m
- 12 pin remote connector strip
- Stylus
- Transport securing device

Use original parts and original accessories

- To maintain best performance, only use original parts and accessories made by KNAUER or a company authorized by KNAUER.

Checking the scope of supply

1. Check that the device and accessories are complete.
2. If anything is missing, consult with KNAUER Technical Support.

European hotline

Languages: German and English
Available by telephone: 8 am to 5 pm (CET)
Phone:+49-(0)30-809727-111
Fax:+49-(0)30-8015010

E-mail: E-mail:support@knauer.net

Device overview

Front view of the device

The input panel and display of the detector are located in the door on the front of the device. **Behind** the door there is the holder for the flow cell with cover plate.

Device door with input field and display

Legend

- ① Display with upper and lower status bar
- ② *AUTO ZERO* key
- ③ Number keys
- ④ *SCAN* key
- ⑤ Arrow keys
- ⑥ Standby key with LED display

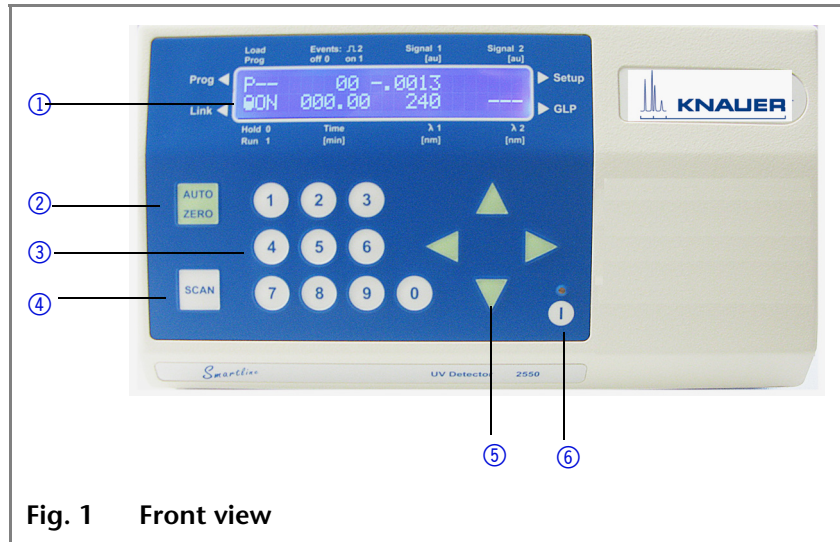

Fig. 1 Front view

Front view of the device with door open

Legend

- ① Knurled-head screws
- ② Cover plate with sensor
- ③ Carriage (holder for flow cell)

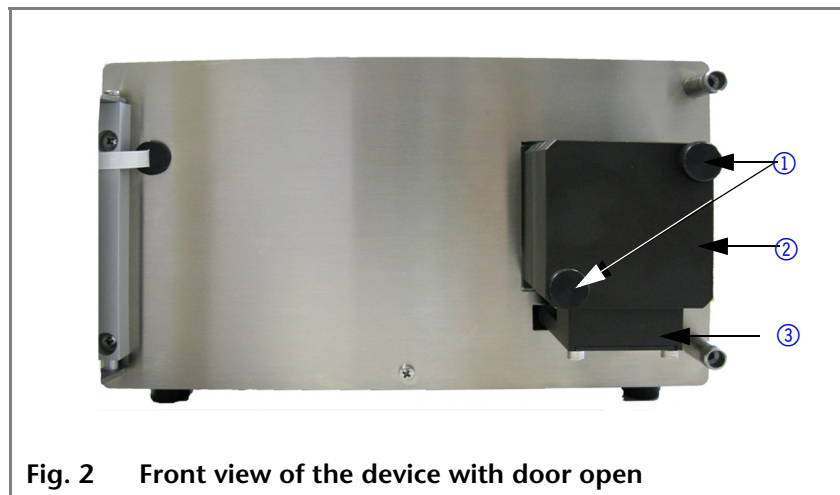



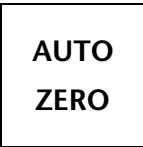
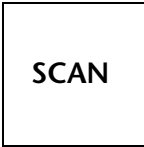
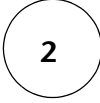
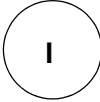

Fig. 2 Front view of the device with door open

Overview of the basic buttons

Button	Name	Explanation
	Vertical arrow keys	The vertical arrow keys serve to modify the corresponding controlled parameters. They are not used to move between the upper and lower status bar of the display. The upper vertical arrow key also has a special function. Once an error message appears in the display, it can be deleted by pressing the  arrow key.
	Horizontal arrow keys	The operation of the horizontal arrow keys moves the cursor to the individual input or switching fields and confirms an entry or selection. If you hold these keys down, you will switch to one of the menus shown to the side of the display (Prog, Link, Setup, GLP).
	<i>AUTO ZERO</i> key	<ol style="list-style-type: none"> 1. Actuating this key triggers a signal auto zero for the currently set wavelength. 2. If the display shows the <i>SCAN</i> menu, then pressing the <i>AUTO ZERO</i> key will effect an auto zero scan over the entire wavelength range. 3. With the <i>AUTO ZERO</i> key, you return to the main menu.
	<i>SCAN</i> key	With this key you switch to the <i>SCAN</i> menu. Pressing it a second time triggers a scan of the selected wavelength range.

Button	Name	Explanation
	Number keys	All ten number keys make possible entry of numeric values at the cursor position.
	Standby key	Pressing the standby key for two seconds puts the detector into a power saving mode. Event inputs and communication interfaces remain active. The standby status is indicated by the lit red LED above this key. To switch back on, press the standby key briefly. Calibration is not performed in this case, as the set wavelength has been fixed.

Note: To disconnect the detector from the mains power, press the power switch on the rear of the device.

Rear view of the device

The rear of the device contains the mains power connection, power switch, connections for external devices, technical symbols and serial number.

Legend

- ① Serial number and manufacturer
- ② Analog outputs (scalable)
- ③ LAN network connection
- ④ Serial interface
- ⑤ Fan opening
- ⑥ Terminal strip *Event and remote control*
- ⑦ Power switch
- ⑧ Power connection

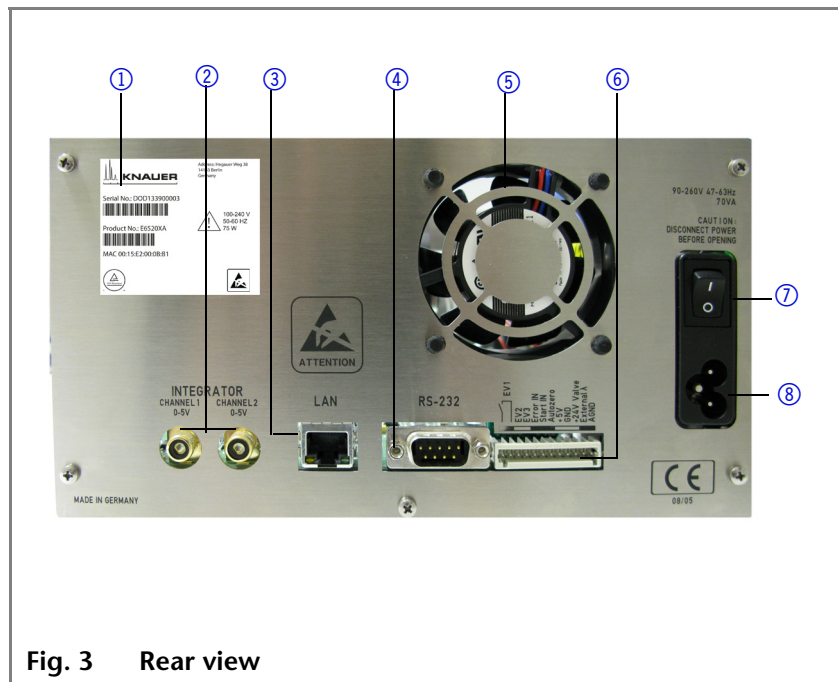

Fig. 3 Rear view

Startup

Checklist before initial operation

Use this checklist to determine whether the detector is ready for initial startup:

- Devices are in the correct location.

Note: Observe the ambient conditions and space requirements!

- The power connection of the detector is plugged in.

If the detector is part of a HPLC system, the following must be observed and operated with chromatography software:

- The network connection to the router is established
- Chromatography software, either from KNAUER or another software supplier, has been installed.
- The capillaries in the solvent bottles have a filter insert.
- Capillaries from the column to the detector and capillaries from the detector to the waste bottle are securely attached.

Note Before the detector is ready to use for measurements, a flow cell must be installed. You can change the optical path length of a preparative flow cell before assembling the flow cell. The optimal path length depends on type and quantity of the sample.

Installation of the flow cell

The supply configuration of this detector only includes a test cell (dummy cell) from KNAUER, which does not have connections for solvent. It is used, for example, to check the lamp intensity, as a dirty flow cell can distort this value. Before using the device with solvents, a KNAUER flow cell must be installed.

A list of the flow cells that can be used can be found in the chapter "Available flow cells for the Smartline detector 2550".

- Prerequisite**
- Detector has been switched off.
 - Power plug has been pulled.

Legend

- ① Inlet of the flow cell
- ② Path length of the flow cell (10 mm)
- ③ Light path
- ④ Outlet of the flow cell
- ⑤ Knurled-head screws
- ⑥ Cover plate
- ⑦ Carriage

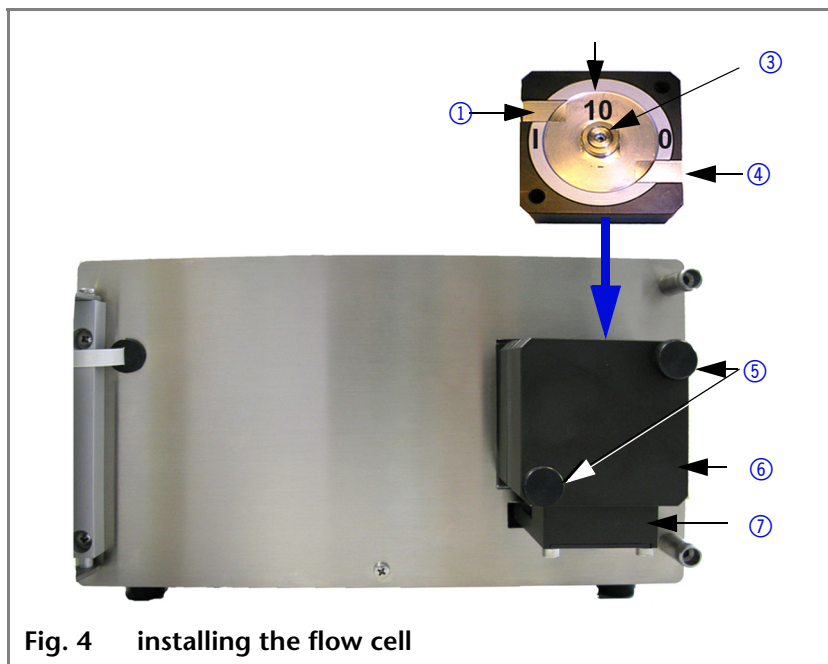

Fig. 4 installing the flow cell

Installing the flow cell

1. Open the device door and loosen and remove both knurled-head screws (⑤) by hand.
2. Hold the flow cell securely and pull the carriage (⑦) out towards the front.
3. Lift up and remove the test cell located in the carriage with two fingers.
4. Insert the new flow cell in the carriage and ensure that the engraved path length (②) of the cell points towards you and the alignment pin of the detector housing fits into the corresponding hole on the rear of the cell.
5. Push the carriage onto the housing. Insert both screws and tighten manually.
6. Connect the incoming and outgoing capillaries at the inlet (①) and outlet (④) of the flow cell.

Changing the path length of a preparative flow cell

At delivery, the path length of a preparative flow cell is set to 2 mm at the factory. To reduce it to 1.25 or 0.5, proceed as follows:

This description applies for the preparative flow cells with order numbers A4066, A4067 and A4068 with 1/8" or 1/4" connections.

Legend

- ① Threaded ring
- ② Stainless steel cover
- ③ PEEK spacer
- ④ Seal holder (compression bushing)
- ⑤ Fiber optics with PTFE seal

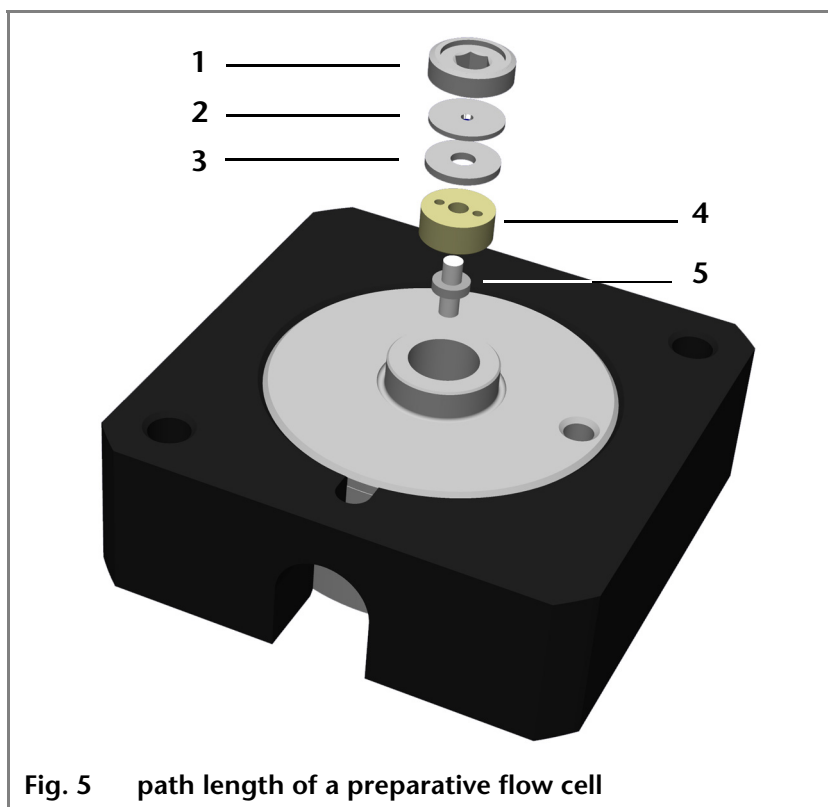

Fig. 5 path length of a preparative flow cell

Procedure for shortening the path length

1. Loosen the threaded ring with a hexagonal spanner.
2. Remove stainless steel cover and the PEEK spacer.
3. Insert the stainless steel cover again and tighten the threaded ring again.

The missing spacer causes the fiber optics to be pushed deeper into the flow cell (0.75 mm), resulting in a shortened optical path length of 1.25 mm. To further shorten down to 0.5 mm, the PEEK spacer on the other cell side must also be removed.

Procedure for lengthening the path length

To increase the path length in steps of 0.75 mm, put the spacers back in.

1. Loosen the threaded ring with a hexagonal spanner.
2. Remove stainless steel cover and fiber optics together with the seal holder with tweezers.
3. To enlarge the path length, push the fiber optics out approximately 1 mm. Please use a clean cloth and avoid touching the fiber optics with your fingers.
4. Put the fiber optics together with the seal holder back into the cell.
5. Insert the PEEK spacer and then the stainless steel cover.
6. Tighten the threaded ring again.

When tightening the threaded ring, the rod-shaped fiber optics is pushed into the correct position in the cell. Inserting a spacer lengthens the optical path length by 0.75 mm. When changing the path length, the PTFE seal does not need to be changed.

Connecting the detector to other devices

Electrical connections

The detector is connected with the *Events and remote control* terminal strip and within a network with the LAN connection to external devices. A computer can also be connected to the detector using the RS-232 interface

Connecting the connector strip with the cable

To control one device through another, you use the pin header. The single ports are used to exchange control signals.

To use remote control, you have to connect cables to the pin header. Therefore, connect the cables firstly to the spring strip and push the spring contacts of the spring strip secondly onto the pins of the pin header.

- Prerequisites**
- The device has been turned off.
 - The power plug has been pulled.

Tools Depressor tool



CAUTION!
Short-circuit hazard.
Turn off the device before connecting it to the pin header. Pull the power plug.



CAUTION! Electrostatic discharge can destroy the electronics!
Wear protective bracelet against electrostatic discharge and ground.

Procedure

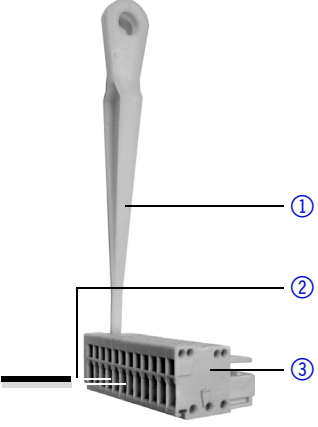
Process	Figure
<ol style="list-style-type: none"> 1. Place the spring strip ③ on a suitable surface. 2. Push the depressor tool ① into the opening on the spring strip. 3. Continue pushing the depressor tool down and lead the cable ② into the front end of the spring strip. 4. Remove the depressor tool. 5. Check whether the cables are tightly attached. 6. Plug the spring strip onto the pin header. 	 <p data-bbox="1002 763 1265 797">Fig. 6 Spring strip</p>

Next steps Finish the installation and perform the initial startup.

Terminal strip *Event and remote control* on the rear of the device

The electric terminal strip *Event and remote control* is used to exchange signals with other devices.

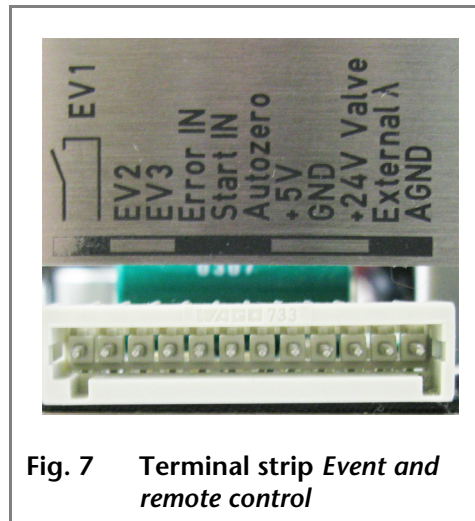

Signal	Explanation
 EV 1	<p>Relay contact Relay dropped out0 Relay actuated1 Pulse: (relay actuated for 1000 ms) Permissible load of the relay contact: 1 A/30 V</p>
EV 2	<p>TTL output Possible levels: Low (<500 mV)0 High (>2 V)1 Pulse (>2 V for 1000 ms)</p> <p>To ensure secure operation, the load resistance of the output may not drop below 10 kΩ.</p>
EV 3	See EV 2
ERROR: IN	<p>TTL input When an error signal is received, running programs are terminated and the message Error input activated appears.</p>
START: IN	<p>TTL input When a signal is received, a program is started in HOLD mode or a link with the corresponding WAIT parameter is started.</p>
AUTOZERO	The current measurement signal is set to zero.
+5 V	Provides a voltage of 5 V with respect to GND. This makes it possible to supply a consumer switched with event 1 (relay). The output is protected with an internal 62 mA fuse.
GND	Reference point for the TTL level
+24 V valve	Event-controlled switching of 24 V against GND. The output is protected with an internal 250 mA fuse. This output can be used for direct operation of a fraction valve.
External λ	Allows external analog control of the detector when the option ANALOG has been selected in the SETUP menu. The control voltage must be applied against AGND.

Signal	Explanation
AGND	Reference point of the voltage at the input External λ .

Manual configuration of the control signals (events)

In the program menu, the events E-1 and E-2 can be activated directly and independent of one another. Here it is relevant for the behavior whether or not E-1 or E-2 has been selected as control event in the FRACTION menu (see Setup menu).

- Procedure**
1. Open the Program menu.
 2. Select the program number.
 3. Press horizontal arrow key to go to the editing mode of the submenu.

Enter values for *events* in the upper status bar, by using the vertical arrow keys.

If none of the two events is used for fractionation, they have the following meaning:

Value	Explanation
0	Event output remains in off state (off).
1	Event output is switched.
	The output is switched on for 1 second and then off again.
-	No status change.

If one of the two events is used for fractionation, then the behavior of the corresponding event fields in the main menu changes.

Value	Explanation
0	If the threshold is exceeded for fractionation, this setting prevents an event from being triggered.
1	When the threshold for fractionation is exceeded, the assigned event switching is triggered.
	Has no meaning in this case

Control of the detector with chromatography software

The detector can be controlled within an LC system with a computer and with software, e.g. KNAUER chromatography software OpenLab, ChromGate or ClarityChrom.

Network connection

The computer is connected via the LAN network connection or the serial interface (RS-232 interface) on the rear of the detector.

Note: A maximum data rate of 80 Hz is available over the LAN interface. The RS-232 interface is limited to a rate of 10 Hz. This means that only the LAN interface can provide a sufficiently fast data transfer for full performance of the device.

In combination with the software, the Smartline detector 2550 can simultaneously measure up to four wavelengths and record an unlimited number of scans during the method run.

If the detector is controlled with software, this is indicated in the display by  symbol, e.g.:

P - -	00	.3450	.2030
		240	+400

For operation of the Smartline detector 2550 using ChromGate or ClarityChrom, no special settings are necessary on the detector.

Connecting a Device in a Local Area Network (LAN) to a Computer

This chapter describes how to set up a local area network (LAN) and how a network administrator can integrate this LAN into a company network. The description applies to the operating system Windows® and all conventional routers.

Note To set up a LAN, we recommend to use a router. The following steps are necessary:

- Process**
1. On the computer, go to the *Control Panel* and check the LAN properties.
 2. Connect the router to the devices and the computer.
 3. On the computer, configure the router to set up the network.
 4. Install the chromatography software from the data storage device.
 5. Switch on the device and run the chromatography software.

Note The port ist set to 10001 at the factory. The IP port numbers in the device configuration of the chromatography software must be identical to those in the device, otherwise the connection fails.

Configuring the LAN Settings

The LAN uses only one server (which is normally the router) from that the devices automatically receive their IP address.

- Prerequisite**
- In Windows power saving, hibernation, standby, automatic Windows update and screen saver must be deactivated.
 - In case you use a USB-to-COM box, the option "Allow the computer to turn off this device to save power" in the *Device Manager* must be deactivated for all USB hosts.
 - Only for Windows 7: For the network adapter, the option "Allow the computer to turn off this device to save power" in the *Device Manager* must be deactivated.
- Procedure**
1. In Windows 7 click on *Start* ⇒ *Control Panel* ⇒ *Network and Sharing Center*.
 2. Double-click on *LAN Connection*.
 3. Click on the button *Properties*.
 4. Select *Internet Protocol version 4 (TCP/IPv4)*.
 5. Click on the button *Properties*.
 6. Check the settings in the tab *General*. The correct settings for the DHCP client are:
 - a) *Obtain an IP address automatically*
 - b) *Obtain DNS server address automatically*
 7. Click on the button *OK*.

Connecting the Cables

To avoid interference, we recommend to operate the HPLC system separate from the company network. This is why we recommend using a router.

A router has several LAN ports and one WAN port that can be used to integrate the LAN into a wide area network (WAN), e. g. a company network or the Internet. On the other hand, the LAN ports serve to set up a network from devices and a computer.

- Note** A patch cable is included in the accessories kit. A router is not included in the scope of delivery. To connect the router to a

WAN, an additional patch cable is required, which is also not supplied within the scope of delivery.

Legend

- ① Modules
- ② Router
- ③ LAN port
- ④ WAN port
- ⑤ Workstation

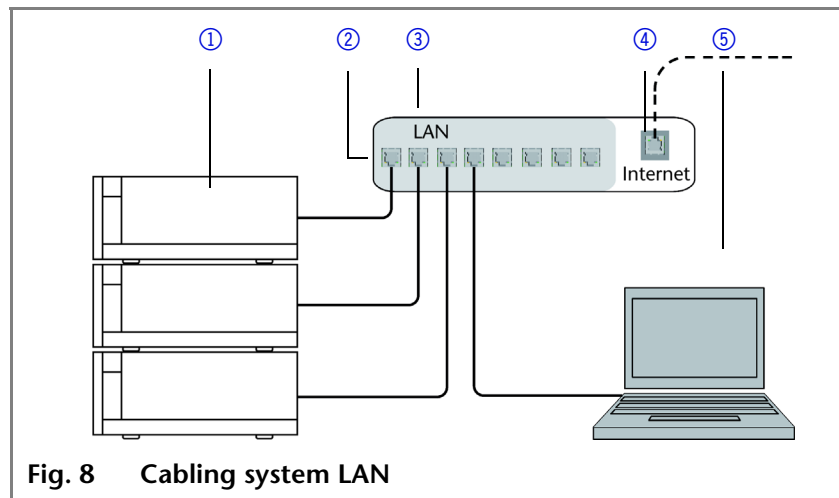

Fig. 8 Cabling system LAN

- Prerequisite**
- Computer is on.
 - There is a patch cable for each device and the computer.

- Procedure**
1. Use the patch cable to connect the router and the computer. Repeat this step to connect all devices.
 2. Use the power supply to connect the router to the mains power system.

Configuring the Router

The router is preset at the factory. You can find a label at the bottom side of the router, on which IP address, user name, and password are printed. These information help to open the router configuration.

- Procedure**
1. To open the router configuration, start your Internet browser and enter the IP address (not for all routers).
 2. Enter user name and password.
 3. Configure the router as DHCP server.
 4. In the router configuration, check the IP-address range and make changes if necessary.

Result Once the router has assigned IP addresses to all devices, the chromatography software can be used to remotely control the system.

Integrating the LAN into a Company Network

A network administrator can integrate the LAN into a company network. In this case the WAN port of the router is used.

Prerequisite There is a patch cable for the connection.

- Procedure**
1. Check that the IP-address range of the router and of the company network do not overlap.
 2. In case of an overlapping, change the IP-address range of the router.
 3. Use the patch cable to connect the router WAN port to the company network.

- Restart all device, including the computer.

Controlling Several Systems Separately in a LAN

Devices connected to a LAN communicate through ports, which are part of the IP address. If more than one HPLC system is connected to the same LAN and you plan on controlling them separately, you can use different ports to avoid interference.

Therefore, the port number for each device must be changed and this same number must be entered into the device configuration of the chromatography software. We recommend to use the same port number for all devices in the same system.

Note The port ist set to 10001 at the factory. The IP port numbers in the device configuration of the chromatography software must be identical to those in the device, otherwise the connection fails.



- Procedure**
- Change the port number of the device.
 - Enter the port number in the chromatography software.

Result The connection is established.

Note Refer to the troubleshooting chapter, if you experience connection problems.

Troubleshooting for Connection Problems

In case no connection between the computer and the devices can be established, go through the following points. Check after each point, if the problem is solved. If you did not manage to locate the problem, call the Technical Support.

<p>1. Check the status of the LAN connection in the Windows taskbar:</p> <ul style="list-style-type: none"> ▪  Connected ▪  Connection not established <p>If no connection was established, test the following:</p> <ul style="list-style-type: none"> ▪ Is the router on? ▪ Is the patch cable connected correctly to the router and the computer? 	<input type="checkbox"/>
<p>2. Check the router settings:</p> <ul style="list-style-type: none"> ▪ Is the router set to DCHP server? ▪ Is the IP-address range sufficient for all the connected devices? 	<input type="checkbox"/>
<p>3. Check all connections.</p> <ul style="list-style-type: none"> ▪ Are the patch cable connected to the LAN ports and not the WAN port? ▪ Are all cable connections between devices and router correct? ▪ Are the cables plugged in tightly? 	<input type="checkbox"/>

<p>4. If the router is integrated into a company network, pull out the patch cable from the WAN port.</p> <ul style="list-style-type: none">▪ Can the devices communicate with the computer, even though the router is disconnected from the company network?	<input type="checkbox"/>
<p>5. In case you own a Control Unit, check the settings in the menu <i>Setup > Network</i>.</p> <ul style="list-style-type: none">▪ Is <i>LAN-DHCP</i> set for controlling?▪ Did the device receive an IP address?	<input type="checkbox"/>
<p>6. Turn off all devices, router, and computer. Firstly turn on the router, secondly the devices and the computer.</p> <ul style="list-style-type: none">▪ Has this been successful?	<input type="checkbox"/>
<p>7. Replace the patch cable to the device with that no connection could be established.</p> <ul style="list-style-type: none">▪ Has this been successful?	<input type="checkbox"/>
<p>8. Check that the IP port in the device/s and chromatography software are identical.</p>	<input type="checkbox"/>

Controlling the detector

Switching the detector on

The device is switched on by the power key on the back of the device.

- Prerequisite**
- Installation has been completed.
 - Flow cell has been assembled.



CAUTION!

Possible damage to the device caused by condensed water!

Allow device to acclimate for 3 h, before it is connected to power supply and taken into operation.

After the devices has been switched on with the power switch on the rear, the device name and, with a delay, the firmware version number appear on the display. The device performs a self-test, which concludes with the message **SYSTEM TEST OK**. The same procedure takes place when the device is switched on from standby mode.

The D₂ lamp then preheats for ignition. This is indicated by **INI** in the lower left of the display. The start routine is completed with an automatic device calibration, which is displayed with **Calibrating...** After this, **ON** appears in the display. The basic settings are similar to those before switching the detector off. The device is now ready for use.

Legend

- ① Display: Program/Link
- ② Event status
- ③ Signal output display
- ④ Arrow key
- ⑤ Standby key
- ⑥ Wavelength display
- ⑦ Number key
- ⑧ Time display
- ⑨ Status of program/link
- ⑩ SCAN key
- ⑪ AUTO ZERO key

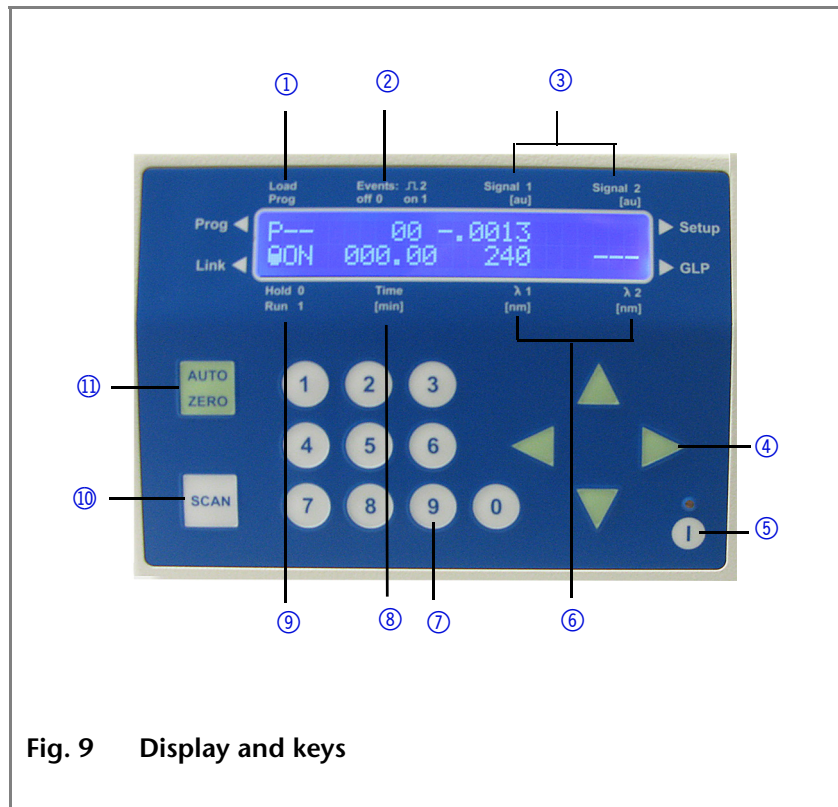

Fig. 9 Display and keys

Procedure for switching the device on

1. Switch the detector on with the power switch on the rear of the device. The device name is displayed followed by the firmware version number.
2. Wait until the detector has performed the system test. This is indicated with the message **SYSTEM TEST OK**.
3. Wait until deuterium lamp has preheated. The preheating is indicated by **INI** in the lower left of the display.
4. Wait until the device calibration is completed. **ON** then appears in the display.

Selecting the wavelength

Procedure for selecting the wavelength

1. Using the arrow keys, position the cursor in one of the two fields for the wavelength (6).
2. Enter the desired value using the number keys or using the vertical arrow keys.
3. If only one wavelength is to be used, then a zero must be entered in the unused field. This deactivates the corresponding detector channel.
4. Confirm entry by using the horizontal arrow keys. Otherwise, the display will return to the previous value after five seconds.

Two spectral edge filters to suppress the second diffraction order are automatically activated if a deuterium lamp is installed and the shortest wavelength in all active channels exceeds an internal default value. The activated filter is indicated by the raised ⁺ in front of the specification of the wavelength.

Options for signal output

The output of a measurement can be configured.

Procedure for measurement configuration

1. Position the cursor in one of the two fields for the signal output (3).
2. Use the vertical arrow keys to select the desired option.

Possible options are:

Options	Explanation
"_"	The signal is inverted.
" ¹ / ₂ "	The display of signal 1 is divided by signal 2.
" ² / ₁ "	The display of signal 2 is divided by signal 1.

The absorption ratio of the measurement can thus be generated to check the chromatographic separation quality at two wave-

lengths. The ratio values are displayed by the symbols **12** or **21** at the decimal point of the absorption value.

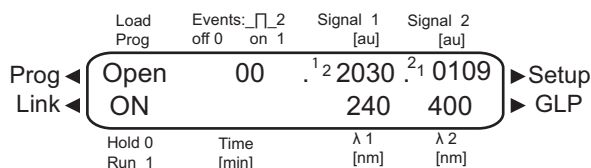

Controlling the main menu

The normal display after switching the device on shows the last set operating mode. The flashing cursor is in the lower left corner of the display. The last loaded program or link is shown in the upper left. Time, event setting and wavelength correspond to the first line of the loaded program. All fields that do not contain active elements are replaced with the “-” character.

Navigation through the main menu

- Use the horizontal arrow keys to navigate through the two lines of the display of the main menu.
- With the number keys, you can increase or decrease the number values.

Practical tip!

With the vertical arrow keys, you can increase or decrease the displayed values.

During navigation through the main menu, the cursor is a flashing rectangle at the current position. During entry, the cursor turns into the underscore character.

Procedure for entering values

1. Use the horizontal arrow keys to put the cursor at the desired position in the display.
2. Use the number keys or the vertical arrow keys to enter a desired value.

Input mode is automatically terminated without saving the entered values if no key is pressed for 5 seconds.

Legend

- ① Setup menu
- ② GLP menu
- ③ Link menu
- ④ Program menu

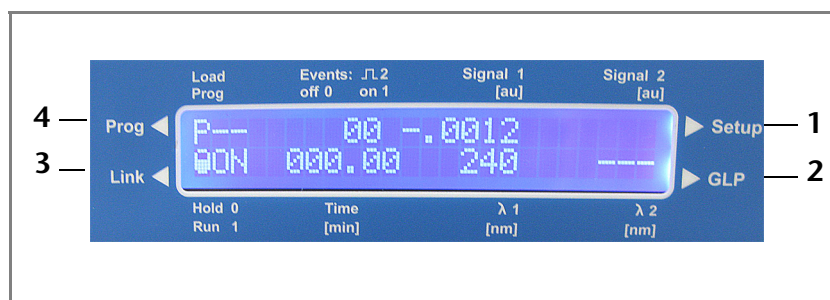

Selecting the Setup menu

Procedure

1. Use the horizontal arrow keys to put the cursor in the top line of the display.
2. Press the right horizontal arrow key for approx. 1 second.
3. Press *AUTO ZERO* or hold one of the horizontal arrow keys for approx. 1 second to return to the main menu.

Selecting the GLP menu

- Procedure**
1. Use the horizontal arrow keys to put the cursor in the lower line of the display.
 2. Press the right horizontal arrow key for approx. 1 second.
 3. Press *AUTO ZERO* or hold the horizontal arrow key for approx. 1 second to return to the main menu.

Selecting the Link menu

- Procedure**
1. Use the horizontal arrow keys to put the cursor in the lower line of the display.
 2. Press the left horizontal arrow key for approx. 1 second.
 3. Press *AUTO ZERO* or hold the horizontal arrow key for approx. 1 second to return to the main menu.

Selecting the Program menu

- Procedure**
1. Use the horizontal arrow keys to put the cursor in the top line of the display.
 2. Press the left horizontal arrow key for approx. 1 second.
 3. Press *AUTO ZERO* or hold the horizontal arrow key for approx. 1 second to return to the main menu.

Controlling the Setup menu

In the SETUP menu, fundamental parameters for controlling the detector are specified.

Navigating through the Setup menu

- Use the horizontal arrow keys to navigate through the two lines of the display.
- Move the cursor onto the diamond icon to navigate through the subitems of the Setup menu by means of the vertical arrow keys.

Practical tip!

With the vertical arrow keys, you can increase or decrease the number values.

Increase or decrease number values

1. Use the horizontal arrow keys to put the cursor at the desired position in the display.
2. Use the number keys to enter a desired value.
3. Use the vertical arrow keys to select the option.
4. Move the cursor onto the diamond icon to navigate through the further subitems of the Setup menu by means of the vertical arrow keys.
5. Press *AUTO ZERO* or hold the horizontal arrow key for approx. 1 second to return to the main menu.

Structure of the Setup menu

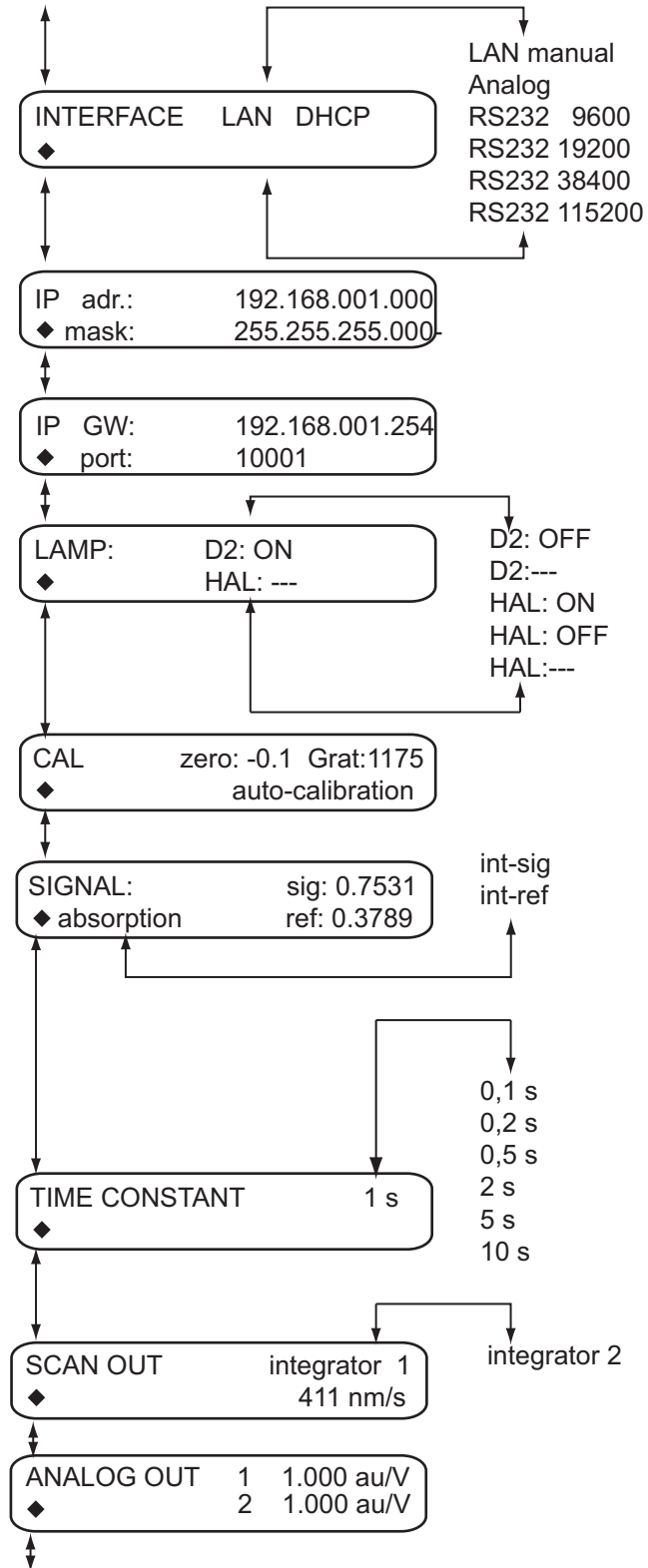

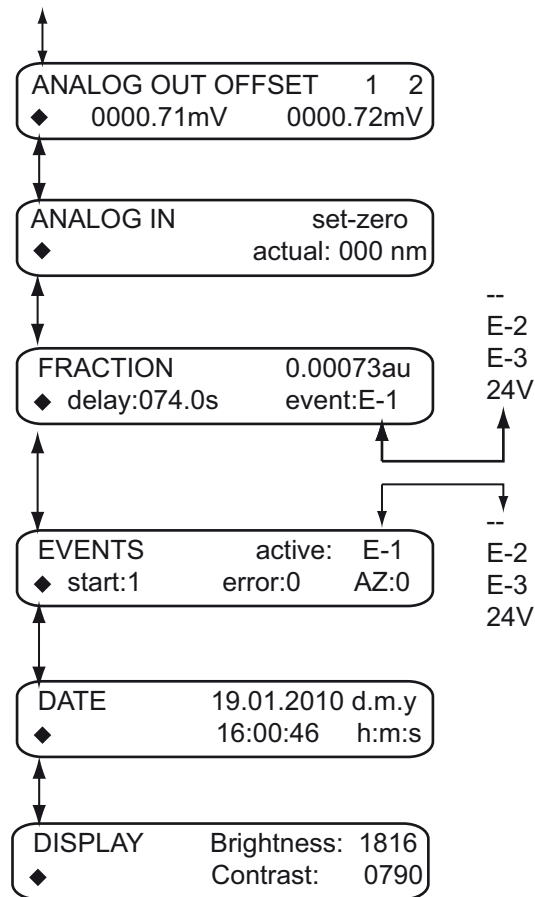

Fig. 10 Structure of the Setup menu

Parameters of the Setup menu

Value	Meaning
INTERFACE	Setting of the connection options of the detector. Connections on the rear of the device.
IP adr:/mask:	Setting of the IP address and the subnet mask.
IP GW:/Port:	Setting of the gateway and the port.
LAMP	Setting of the lamp configuration (deuterium, halogen or tandem). A source that is not installed is indicated by ---.

Value	Meaning
CAL	<p>Display of the effective line density of the optical grating in lines/mm and offset of the unbent light. Necessary for automatic wavelength accuracy and correction thereof. Manual setting not necessary, automatic calibration is started with the vertical arrow keys and initiates a complete calibration procedure.</p> <p>Note: It is recommended that after each change of the flow cell or solvent, an auto calibration should be performed to optimally adjust the detector properties. When doing so, make sure that the flow cell is completely filled with solvent and free of air bubbles.</p>
SIGNAL	<p>Selection of the signal source that will be used for all outputs. Selection between absorption, int-sig (signal channel) and int-ref (reference channel).</p>
TIME CONSTANT	<p>Selection of a time constant to be used for signal smoothing. The larger the value of the selected time constant, the stronger the applied signal smoothing. The surfaces of the elution peaks remain, their profile can however be changed in particular with long time constants.</p>
SCAN OUT	<p>Adjustment of the output speed of a previously recorded spectrum of the downstream recording device and the specification of the analog output over which the spectrum is output. The permissible spectral range is 190–900 nm.</p>
ANALOG OUT	<p>Scaling of the two analog outputs according to the requirements of the recording device. Specification of the range over which the output signal extends. Maximum permissible is 5 au/V.</p> <p>If int-sig or int-ref is selected as data source, the scaling unit is 1/V.</p>

Value	Meaning
ANALOG OUT OFFSET	<p>Constant offset of the base line in both analog outputs. Specification of a positive value (0–5 V) for an offset in mV possible. This value is added to the corresponding analog output signals. Particularly useful when using chart records if the recordings of both channels should be separated or inverse chromatography is to be realized. Any negative signals must be made viewable with an offset as the analog outputs cannot provide a negative voltage.</p>
ANALOG IN	<p>Option for calibrating the analog input of the terminal strip for an external wavelength control. Using the vertical arrow keys in the set-zero field, it is possible define an applied input voltage as spectral zero point with a wavelength of 000 nm. If a different positive control voltage is applied, the current "λ" field displays a resulting wavelength with scaling of 100 nm/V. This wavelength can then be adjusted finely by using the vertical arrow keys. Thus a second calibration point is generated, which modifies the scaling.</p> <p>Note: With respect to the maximum linearity, it is recommended to scale the input voltage to 100 nm/V. The longest accessible wavelength corresponds thus to a control voltage of 9 V.</p>

Value	Meaning
FRACTION	<p>In order to activate ports 1 and 2 on back of the detector for fraction collecting, event 1 must first be activated from the main screen. The corresponding port (1 or 2) must also be selected in the Fraction collection menu, together with a threshold value (AU) and optionally a delay time. When the threshold value is reached/exceeded, the selected port is opened and the event field remains "active" on the main screen. When the signal falls below the threshold, the port is closed and the event field remains "active" on the main screen. In order to activate ports 3 and 4 on back of the detector for fraction collecting, the corresponding port (3 or 4) must be selected in the Fraction collection menu, together with a threshold value (AU) and optionally a delay time. When the threshold value is reached/exceeded, the selected port is opened and the event field remains "inactive" on the main screen. When the signal falls below the threshold, the port is closed and the event field remains "inactive" on the main screen.</p>
EVENTS	<p>Used for testing the terminal strip functions. The connections E-1 to E-3 and the 24 V output can be selected, which can be activated individually.</p>
DATE	<p>Setting of the time and date. Day, month, year, hour, minute and second are set independently of one another.</p> <p>Practical tip: Synchronization with an external clock is only possible when using the supplied service tools, which simplifies the setting when the time zone changes. From the factory the device clock is set to Central European Time.</p>
DISPLAY	<p>Here the brightness and contrast of the display can be set.</p>

Controlling the GLP menu

All displays of the GLP menu are for information purposes only. They provide information about the use of the detector as well as an overview of the configuration and condition of the device. Entries are not possible.

Note: The supplied service tool records additionally all device data and is used for service remote diagnostics.

Navigating through the GLP menu

- A diamond icon is displayed on the left of the lower line in the display. Move the cursor onto the diamond icon to navigate through the subitems of the GLP menu by means of the vertical arrow keys.
- Press *AUTO ZERO* or hold the horizontal arrow key for approx. 1 second to go to the main menu.

Structure of the GLP menu

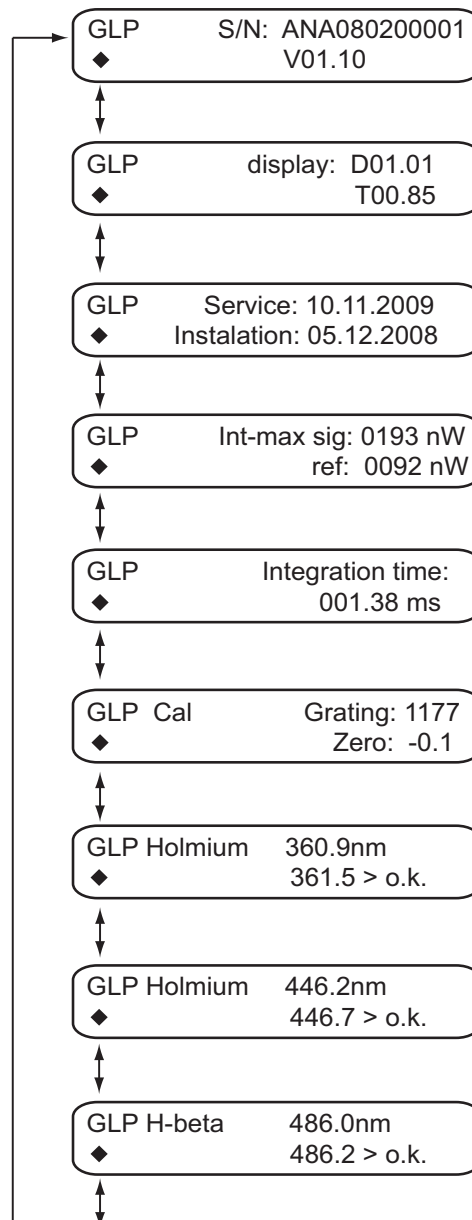

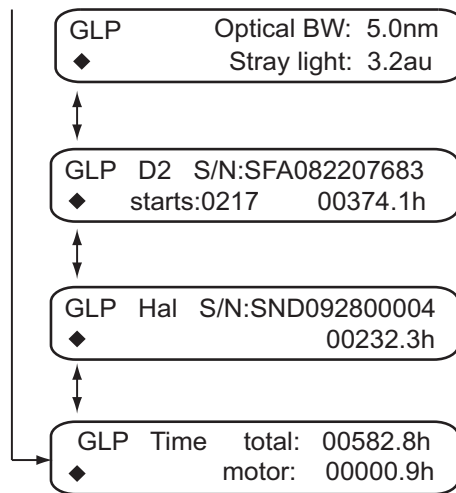

Fig. 11 Structure of the GLP menu

Parameters of the GLP menu

Value	Meaning
GLP S/N	Display of the serial number and the currently installed firmware version.
GLP display	Display of the firmware version.
GLP Service Installation	Display of the initial installation and last service.
GLP Int-max	Display of the maximum light output in the measurement and reference channel. This specification serves mainly to evaluate the lamp aging. This value is determined during device calibration and thus does not change during the work phase of the detector but only when calibration is performed again.
GLP Integration time	Display of the optimal integration time of the detector, which is automatically determined during calibration. The value is dependent on the status of the lamps and the flow cell that is used.
GLP Cal	Display of the line density of the optical grating as well as the fine deviation of the zeroth spectral order. Both values are used for exact positioning on the selected wavelength.
GLP Holmium GLP Holmium GLP H-beta	After device calibration, the spectral reference values are measured with an internal holmium filter as well as the H-beta line of the deuterium lamp as normal line and their position verified. If the difference between nominal and actual value is less than specified in the device's data sheet, the line position is marked o.k.
GLP optical BW stray light	Display of the results of the self-test for optical bandwidth and approximate linearity. The linearity is determined by a short procedure for determination of scattered light at a spectral point during calibration.
GLP D2 GLP Hal	Display of the serial numbers of the installed lamps, their operating time and, in case of the deuterium lamp, also the number of lamp starts. If a source is not installed, it is indicated by ---.

Value	Meaning
GLP time	Display of the total operating time of the detector and the run time of the grating motor. The grating motor operating times are only registered when the device operates in multiple channel mode.

Controlling the Program menu

The Program menu is used to list and create programs.

The 2550 detector can save up to 19 programs and up to 99 program lines. Program 20 is reserved for a special wake-up program for a time-delayed execution of the links or programs. Max. 10 program links between defined programs can be created and saved.

Programs can be created for the following functions:

- Specification or modification of the wavelengths
- Definition of signal events during a wavelength program

Creating a program

- Procedure**
1. Select the Program menu.
 2. Select the program number.
 3. Press horizontal arrow key to go to the editing mode of the submenu.
 4. Enter desired values.
 5. To specify the desired start time in the submenu, position the cursor on the diamond icon and press the vertical arrow keys.
 6. Press *AUTO ZERO* key to return to the main menu.

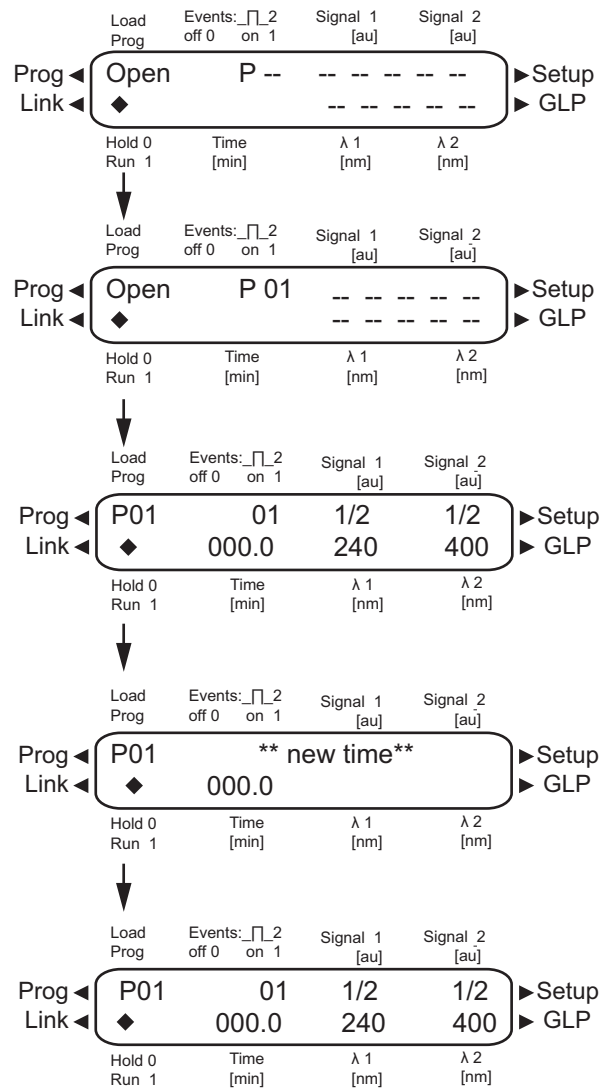

Fig. 12 Creating a program

Running a program

Before a program is run, it must be loaded.

- Procedure**
1. Select the Program menu.
 2. Select the program number.
 3. Press horizontal arrow key to go to the editing mode of the submenu.
 4. Press *AUTO ZERO* key to go to *ON/OFF* mode.
 5. Enter the program number and confirm with the horizontal arrow key. The display switches to *HOLD* mode.
 6. Place the cursor onto *HOLD* and press *1*. The display switches to *RUN* mode (program is running).

7. After the program has been completed, press *AUTO ZERO*. The display switches to *ON/OFF* mode.

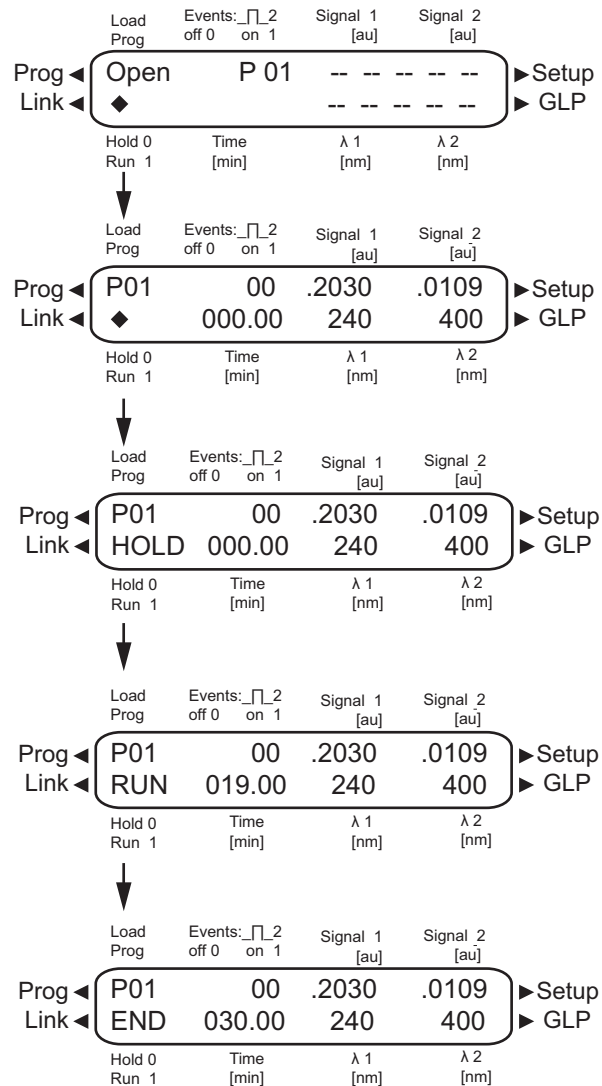

Fig. 13 Running a program

Changing a program

When values are entered, the old values are overwritten.

Procedure

1. Select the Program menu.
2. Select the program number.
3. Press horizontal arrow key to go to the editing mode of the submenu.
4. Using the vertical arrow keys, navigate to the program line that is to be changed.
5. Enter the desired value.

6. Position cursor on the diamond icon and hold the horizontal arrow key down to exit the submenu.

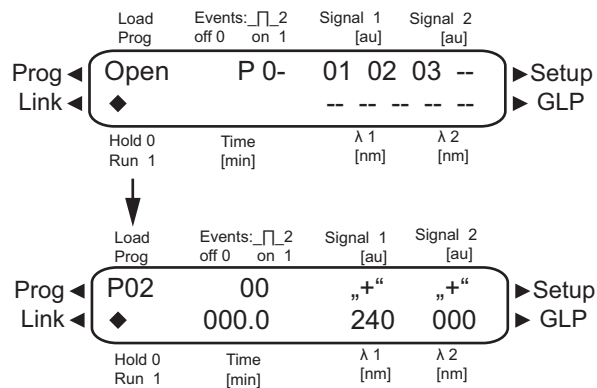

Fig. 14 Changing a program

Deleting a program

- Procedure**
1. Select the Program menu.
 2. Enter program number 0.
 3. Press horizontal arrow key to go to the editing mode of the submenu.
 4. Enter number of the program to be deleted.
 5. Press vertical arrow key to confirm.

Note: Running programs and programs which are contained in a running link cannot be deleted.

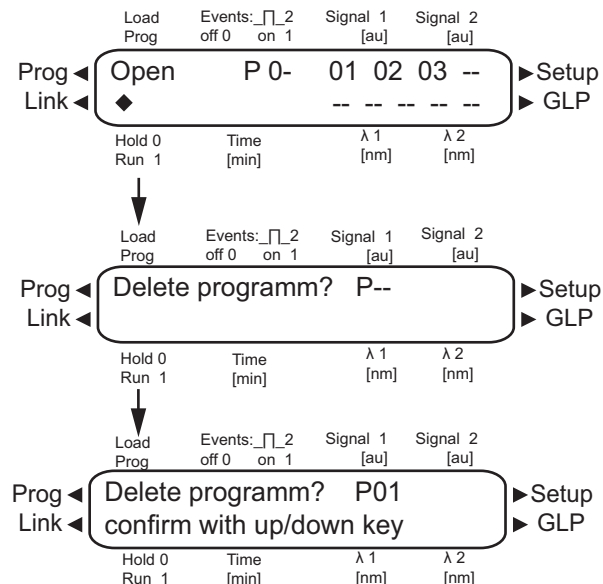

Fig. 15 Deleting a program

Creating a program with preselectable start time

Program number 20 serves as a wake-up program. Here a program or link can be loaded at a prescribed time.

The device is switched on from standby mode at the desired time, the D₂ sources is ignited and put into the so-called *HOLD* state.

Note: Make sure that the date and time configured in the Setup menu are correct.

- Procedure**
1. Select the Program menu.
 2. Enter program number 20.
 3. Press horizontal arrow key to go to the editing mode of the submenu.
 4. Enter the date and time for the program start.
 5. Enter the number of the program that should start at the pre-set time.

To interrupt the current *WAKE UP* program, enter another program number.

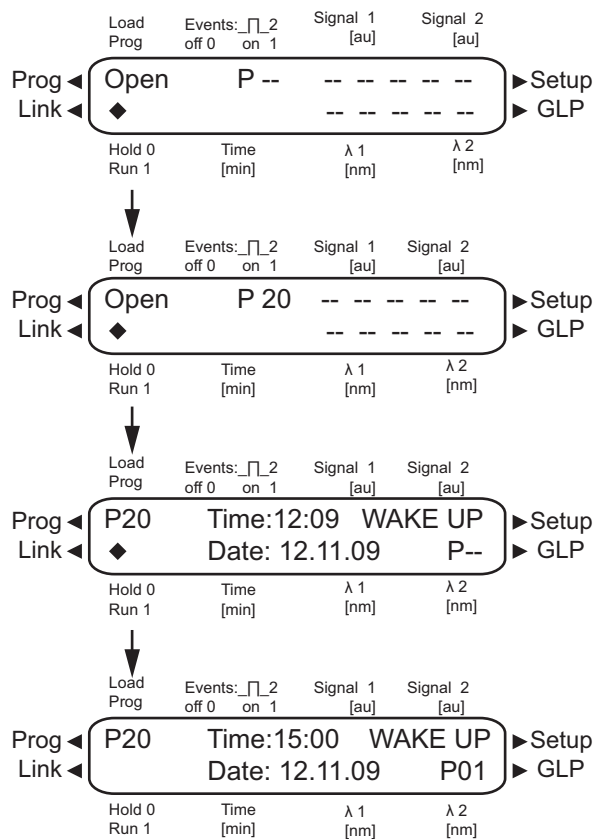

Fig. 16 Creating a wakeup program

Controlling the Link menu

Links are references between existing programs, which can be defined and edited, like the programs themselves.

Links are created and listed in the Link menu.

Navigating through the Link menu

Use the horizontal arrow keys to navigate through the two lines of the display. A diamond icon is displayed on the left of the lower line. Move the cursor onto the diamond icon to navigate through the subitems of the Link menu by means of the vertical arrow keys.

With the vertical arrow keys, you can increase or decrease the number values by one value.

Increase or decrease number values

1. Use the horizontal arrow keys to move the cursor to the desired position in the display.
2. Use the number keys to enter a desired value.
3. Move the cursor onto the diamond icon to navigate through the further subitems of the Link menu by means of the vertical arrow keys.
4. Press *AUTO ZERO* key or hold the horizontal arrow key for approx. 1 second to return to the main menu.

Creating a link

A maximum of ten links between defined programs can be created and saved.

Every link contains a program number **P** (01–19), a number **R** for repetitions (1–99) and a programmable wait status **W** (0 or 1).

Procedure

1. Select the Link menu.
2. Enter the link number.
3. Press horizontal arrow key to go to the editing mode of the submenu.
4. Move the cursor to position *P* in the display and enter the program number.
5. Move the cursor to position *R* (*R* = Repeat) and enter the value (number of repetitions for the specified program).
6. Move the cursor to position *W* in the display and enter 1 or 0.

Note: If the **W 0** (*W* = Wait) setting is used, the detector waits for an external start signal or for the user to press number 1 (run). Every subsequent line starts

immediately. If the **W 1** setting is used, the link sequence is run without interruption.

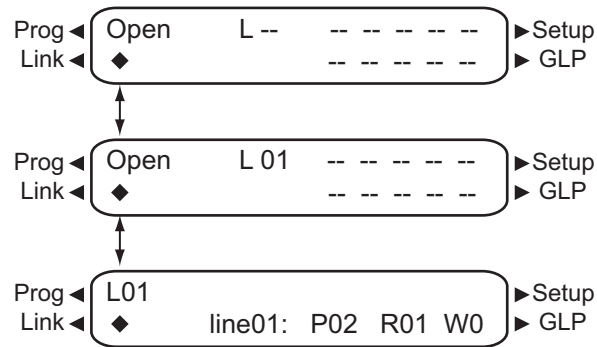

Fig. 17 Creating a link

Executing a link

After the link has been executed, the detector stops. The display switches to the *END* mode.

Procedure

1. Select the Link menu.
2. Enter the link number.
3. Press horizontal arrow key to go to the editing mode of the submenu.
4. Press *AUTO ZERO* to go to *ON/OFF* mode.
5. Enter the link number.
6. Press number 1. The display switches to *HOLD* mode.
7. Press number 1 again. The display switches to *RUN* mode (linked program is running).

8. After the link has been completed, press *AUTO ZERO*. The display switches to *ON/OFF* mode.

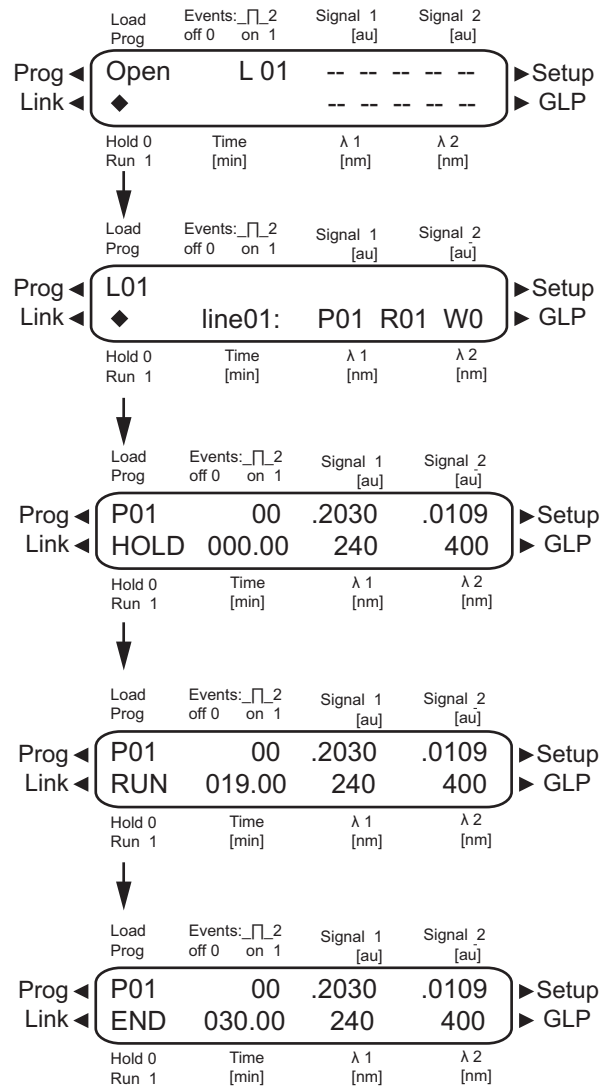

Fig. 18 Executing a link

Deleting a link

- Procedure**
1. Select the Link menu.
 2. Enter link number 0.
 3. Press horizontal arrow key to go to the editing mode of the submenu.
 4. Enter number of the link to be deleted.
 5. Press vertical arrow key to confirm.
- Note:** Running links cannot be deleted.

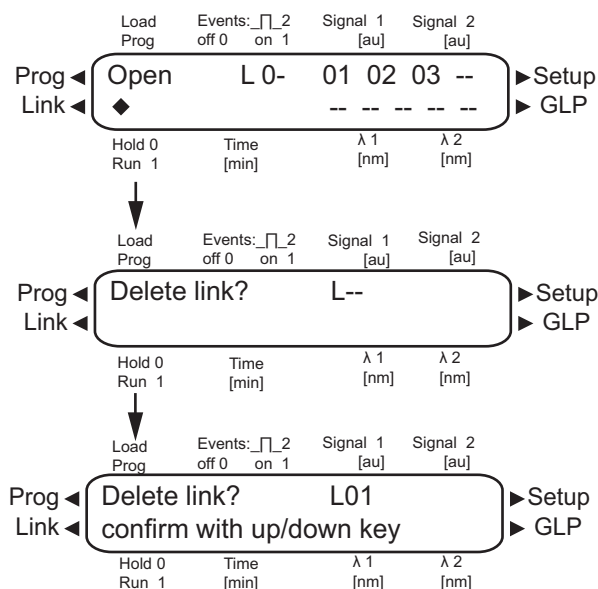

Fig. 19 Deleting a link

Controlling the Scan menu

The Scan menu enables the following functions:

- Selection of the wavelength range for the scan and the autozero scan.
- Output of the saved scan data.

The Smartline detector 2550 can save a scanned spectrum and output it via the analog output 1 or 2 selected in the Setup menu.

Autozero scan Before recording spectra, the detector must perform the so-called autozero scan. During this procedure the solvent spectrum is measured and the measurements along the entire set wavelength range are set to zero. This can take some time, as the wavelength is set via an adjustable grating that must be moved for every wavelength.

Note: For each change of solvent, the autozero scan should be performed again.

- Procedure for the autozero scan**
1. Press *SCAN* to enter the Scan menu.

2. Press *AUTO ZERO*. The detector scans the set wavelength range and sets all measured values to zero.
3. Wait until the main menu is shown in the display. The autozero scan has now been completed.

Performing wavelength scans

For a wavelength scan, the UV spectrum of a sample is recorded. The wavelength of light at the output gap is changed by turning the optical grating continuously. During the procedure, the light absorption is measured constantly.

Procedure for wavelength scans

1. Press *SCAN* to enter the Scan menu. In the first line the signal sources **absorption**, **int-sig**, or **int-ref** can be selected. The second line is used to specify the scan range in nanometer.

2. Press *SCAN* key again. The scan is executed immediately and saved. The display returns to the main menu.

To subsequently output the saved scan, proceed as follows:

1. Press *SCAN* key again to enter the Scan menu.
2. Using the arrow keys, position the cursor in the OUT field in the upper line.

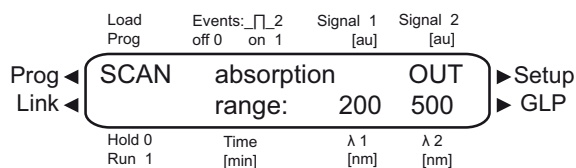

3. Pressing one of the vertical arrow keys activates the scan output. The progress of the output is indicated by the continuing rise in the upper wavelength.

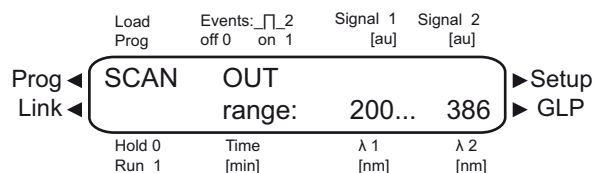

Maintenance and care

that work areas are always well-ventilated! When performing maintenance tasks on the device, always wear safety glasses with side protection, protective gloves, and an overall.

All wetter components of a device, e. g. flow cells of detectors or pump heads and pressure sensors for pumps, have to be flushed with isopropanol first and water afterwards before being maintained, disassembled or disposed.

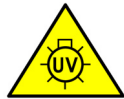
**WARNING!**

Irritation of retina through UV light! Concentrated UV light can leak out from the flow cell or the fiber optic connectors.

Switch off the device and pull the power plug.

**CAUTION!**

Performing maintenance tasks on a switched on device can cause damage to the device.

Switch off the device and pull the power plug.

Users may perform the following maintenance tasks themselves:

- Regularly check the light intensity of the D₂ lamp (best before 2000 operating hours).
- Inspect the flow cell assembly
- Clean the flow cell.
- Replace the flow cell.

Proper maintenance of your HPLC device will ensure successful analyses and reproducible results.

Contacting the Technical Support

You have various options to contact the Technical Support:

Phone +49 30 809727-111

Fax +49 30 8015010

E-mail support@knauer.net

You can make your requests in English and German.

Maintenance Contract

The following maintenance work on the device may only be performed by the manufacturer or a company authorized by the manufacturer and is covered by a separate maintenance contract:

- Opening the device
- Removing the hood or the side panels.

Cleaning and Caring for the Device



CAUTION!

Intruding liquids can cause damage to the device!
Place solvent bottles next to the device or in a solvent tray.

Moisten the cleaning cloth only slightly.

All smooth surfaces of the device can be cleaned with a mild, commercially available cleaning solution, or with isopropanol.

Cleaning the flow cell

Increased noise of the base line and reduced sensitivity can be a result of a dirty flow cell.

Often it is sufficient to flush the flow cell to restore optimal sensitivity.

Flushing the flow cell

The following solvent is recommended for flushing:

- 1 mol/l HCl
- 1 mol/l NaOH
- Ethanol
- Acetone
- Water

- Procedure**
1. Fill one of the recommended solvents into a syringe.
 2. Inject it into the inlet of the flow cell and allow it to act for 5 minutes.
 3. Flush with plenty of water
 4. The cell is then dried in a nitrogen stream.

Note: Do not use compressed air for drying, as this often contains microscopic oil drops that can be deposited onto the cell.

If flushing does not have the desired effect, all flow cells can be disassembled to clean the lens.

Cleaning the lens of an analytical flow cell

This description applies for the analytical flow cells A4061V2, A4042, and A4045.

- Prerequisite**
- Device has been switched off.
 - Flow cell has been removed.

Legend

- ① PTFE seal ring
- ② Lens
- ③ Lens holder (compression part)
- ④ Threaded ring

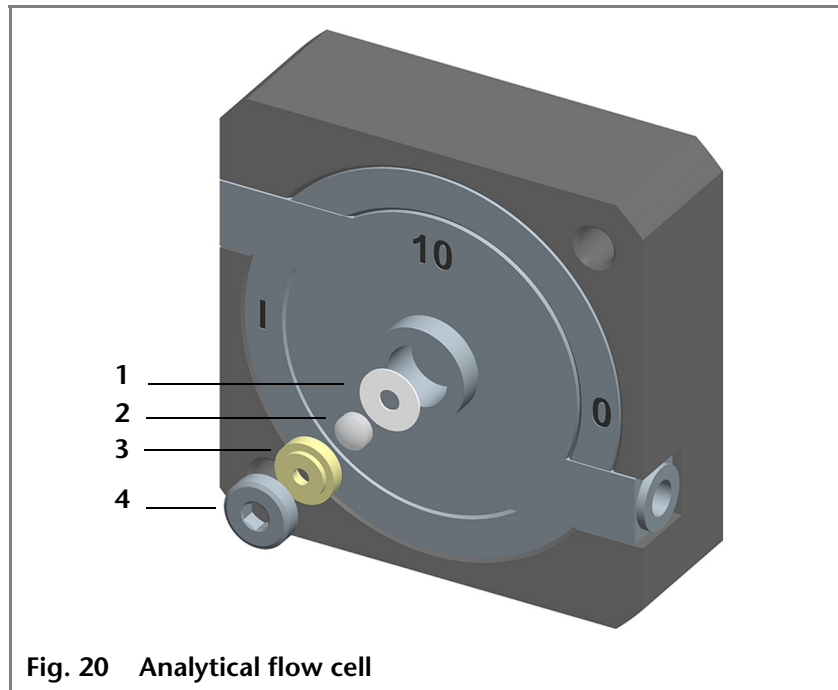

Fig. 20 Analytical flow cell

Procedure for cleaning the lens

1. Loosen the threaded ring (4) with the 3 mm hexagonal spanner included with the flow cell.
2. Remove the lens holder (3) with tweezers or by gently tapping and place on a clean surface.
3. The lens (2) is protected by a PTFE seal (1). This must be renewed every time the lens is disassembled.
4. Remove the lens and clean with a clean, soft cloth or with an appropriate solvent in an ultrasonic bath. Ensure that the clean lens is not touched by fingers.
5. Then place the flow cell back and ensure that the new PTFE seal does not interrupt the light path.
6. Next, tighten the threaded ring with the hexagonal spanner in such a manner that damage to the lens is avoided.

Cleaning the fiber optics of a preparative flow cell

This description applies for the preparative flow cells A4066, A4067, A4068 and A4069.

The preparative flow cells have a rod-shaped fiber optic instead of the concave lens of the analytical cells.

Prerequisite

- Device has been switched off.
- Flow cell has been removed.

Legend

- ① Threaded ring
- ② Stainless steel cover
- ③ PEEK spacer
- ④ Seal holder (compression bushing)
- ⑤ fiber optics with PTFE seal

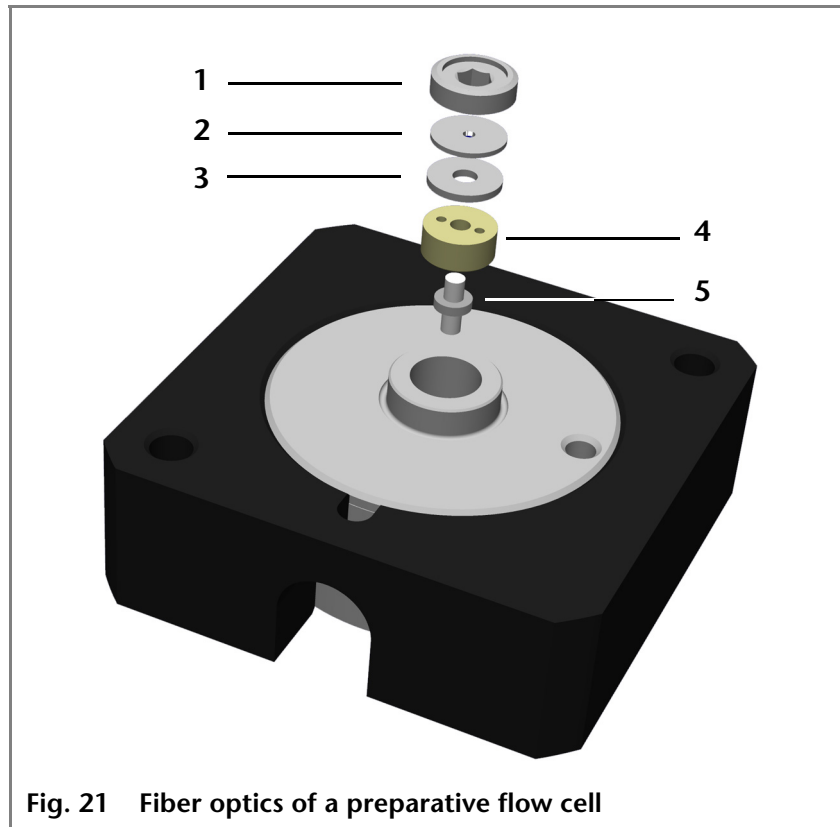

Fig. 21 Fiber optics of a preparative flow cell

Procedure for cleaning the fiber optics

1. Loosen the threaded ring with the 3 mm hexagonal spanner included with the flow cell.
2. Remove stainless steel cover and the PEEK spacer (not part of A4069).
3. Using tweezers, remove the holder with the fiber optics.
4. Carefully push the fiber optics out of the holder and wipe off the PTFE seal. The PTFE seal must be renewed every time the fiber optics are cleaned.
5. Clean the fiber optics with a clean, soft cloth or with an appropriate solvent in an ultrasonic bath. Ensure that the clean fiber optics are not touched by fingers.
6. Then place the flow cell back and ensure that the new PTFE seal does not interrupt the light path.
7. Next, tighten the threaded ring with the hexagonal spanner in such a manner that damage to the lens is avoided.

Result

The fiber optics have been cleaned and put back into the flow cell.

Replacing the flow cell

UV light will cause the flow cells to become blind with time (solarization), making them no longer suitable for use.

A list of the flow cells that can be used can be found in the chapter "Available flow cells for the Smartline detector 2550".

Legend

- ① Inlet of the flow cell
- ② Outlet of the flow cell
- ③ Knurled-head screws
- ④ Cover plate
- ⑤ Carriage

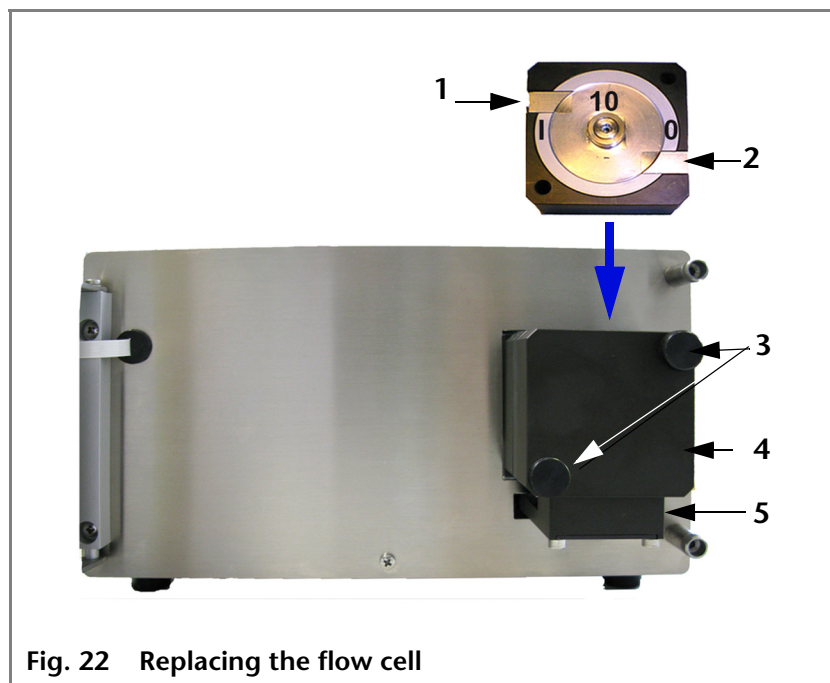

Fig. 22 Replacing the flow cell

Prerequisite The device is switched off and the power cable has been unplugged.

Procedure The following steps are recommended for disassembling the flow cell:

1. Switch off the device and pull the power plug.
2. Open the device door.
3. Remove capillaries at the inlet (1) and outlet (2) of the flow cell.
4. Unscrew the knurled-head screws (3) of the cover plate. Hold the flow cell securely with your hand during this procedure.
5. Pull out the carriage of the flow cell (5) towards the front.
6. Lift the flow cell up and out.
7. Insert new flow cell from above into the carriage. Continue to hold the flow cell securely.
8. Push the carriage back into the detector.
9. Screw the knurled-head screws back into the cover plate (4) and tighten.

Result Flow cell has been replaced.

Disposal

	Hand in old devices or disassembled old components at a certified waste facility, where they will be disposed of properly.
AVV marking in Germany	According to the German "Abfallverzeichnisverordnung" (AVV) (January, 2001), old devices manufactured by KNAUER are marked as waste electrical and electronic equipment: 160214
WEEE registration	KNAUER as a company is registered by the WEEE number DE 34642789 in the German "Elektroaltgerätereister" (EAR). The number belongs to category 8, which, among others, comprises laboratory equipment. All distributors and importers are responsible for the disposal of old devices, as defined by the WEEE directive . End-users can send their old devices manufactured by KNAUER back to the distributor, the importer, or the company free of charge, but would be charged for the disposal.
Eluents and other operating materials	All eluents and other operating materials must be collected separately and disposed of properly. All wetted components of a device, e. g. flow cells of detectors or pump heads and pressure sensors for pumps, have to be flushed with isopropanol first and water afterwards before being maintained, disassembled or disposed.

Storage

The device can be stored within the following ambient conditions:

Humidity: below 90 % noncondensing

Temperature range: 4 - 40 °C, 39.2 - 104 °F

Troubleshooting

System messages

Inform the Technical Support of the manufacturer in case the system message repeats itself.

The system messages are sorted alphabetically:

System message	Solution
5-phase motor init failed	Switch the device off and on again. Check cable connection. If the system message appears again, notify KNAUER Technical Support.
At least one wavelength must be valid	Check whether at least one channel is on. Check that the entered the wavelengths are in the permissible range (190 nm to 900 nm).
Calibration failed	Restart the device. Check that lamps, motor and filter are functioning correctly. If the system message appears again, notify KNAUER Technical Support. Restart calibration at the device or in the chromatography software.
Cannot delete active program/link	First pause link, then delete program.
Cannot edit program from the running link	First pause link, then edit data using chromatography software.
Cannot initialize LAN	Check cables and connections in local area network.
Cannot operate an uncalibrated instrument	Restart the device. Wait until calibration is completed. If the system message appears again, restart the device.
Cannot operate with an empty link	Create a link.
Cannot proceed: D2 lamp heating.	Wait until D2 lamp has preheated.
Cannot proceed: lamps are off.	Test whether the lamps have been switched on.
Cannot read data from FRAM	Restart the device. If the system message appears again, notify KNAUER Technical Support.

System message	Solution
Cannot read RTC	Restart the device. If the system message appears again, notify KNAUER Technical Support.
Cannot set acquisition parameters	Modify the entry.
Cannot start time table	Edit the data by means of the chromatography software.
Cannot write data on FRAM	Restart the device. If the system message appears again, notify KNAUER Technical Support.
CRC failed	Restart the device. If the system message appears again, notify KNAUER Technical Support.
D2 Lamp read failure Ignition counter	If the system message appears again, notify KNAUER Technical Support. The lamp has to be replaced.
D2 Lamp read Ignition counter	If the system message appears again, notify KNAUER Technical Support. The lamp has to be replaced.
D2 Lamp read lamp lifetime	If the system message appears again, notify KNAUER Technical Support. The lamp has to be replaced.
D2 Lamp does not start!	Switch off lamp on touchscreen and turn it on again. If the system message appears again, notify KNAUER Technical Support. The lamp unit has to be replaced.
Data acquisition active	No entries are possible. First stop acquiring measurement data, afterwards you can make a new entry.
Error input activated	Check the external devices and cable connections.
Error programming flash	Restart the device. If the system message appears again, notify KNAUER Technical Support.
Filter move error	Restart the device. If the system message appears again, notify KNAUER Technical Support.
I2C failed for lamp(s)	Restart the device. If the system message appears again, notify KNAUER Technical Support.

System message	Solution
I2C failed for panel	Restart the device. If the system message appears again, notify KNAUER Technical Support.
I2C Init failed	Restart the device. If the system message appears again, notify KNAUER Technical Support.
I2C operation failed	Restart the device. If the system message appears again, notify KNAUER Technical Support.
Instrument remote controlled	This entry is not executable. Quit software program.
Insufficient access	Change the entry.
Invalid command	Check the cable connections. Change the entry.
Invalid parameter(s)	Check the validity of the parameters.
Invalid time in time table	Correct the time entry.
Invalid time table index	Change the entry in the program line.
Link is loaded	First unload the link then change the link or delete it.
Link is running	Wait until the link has been executed, then change the link or delete it.
Memory error	Restart the device. If the system message appears again, notify KNAUER Technical Support.
No link available	Create a link and edit it.
No link available Pls edit link first	Create a link and edit it.
No space for scan is available	Check the detector. Check the number of program lines. A maximum of 99 program lines are possible.
No stored scans available	Edit the data by means of the chromatography software. Save the scan.
No time table to start	Edit the data by means of the chromatography software.

System message	Solution
Not enough space to store link	Check the detector. Check the number of program lines. A maximum of 99 program lines are possible.
Not enough space to store program	Check the detector. Check the number of program lines. A maximum of 99 program lines are possible.
Not supported	Change the entry.
Program does not exist	Create a program.
Program is running.	Quit program or wait until program has been completed.
Scan is already active.	Cancel scan procedure or wait until scan procedure has been completed.
This link is used in Wake up	First quit or delete wakeup program (wu = Wake Up), then edit or delete link.
This program is used in a link	First pause or delete link, then edit or delete data by means of the chromatography software.
This program is used in Wake up	First quit or delete wakeup program (wu = Wake Up), then edit or delete data by means of the chromatography software.
Time already exists	Correct the time entry.
Time table is not active	The device is in <i>Standalone mode</i> , no program is running. If you try to quit a non-existent program sequence, this message appears.
Time table is not loaded	First load the program, then start the program.
Time table line is empty	Edit the program line.
Too many lines in program	Check the number of program lines. A maximum of 99 program lines are possible.
Wrong Line number	Change the entry in the program line.

Technical data

Smartline detector 2550



Detector type	Variable multiple wavelength UV/VIS detector
Detection channels	4 (software), 2 (standalone)
Light source	Deuterium (D2) with integrated GLP chip (one lamp version) Deuterium (D2) and halogen lamps with integrated GLP chip (two lamp version)
Wavelength range	190 - 750 nm (one lamp version) 190 - 900 nm (two lamp version)
Spectral bandwidth	6 nm at H _α line (FWHM)
Wavelength accuracy	± 2.0 nm (verification with integrated holmium oxide filter)
Wavelength precision	0.4 nm (ASTM E1657-98)
Noise	± 0.75 × 10 ⁻⁵ AU at 254 nm (ASTM E1657-98)
Drift	± 1.5 × 10 ⁻⁴ AU/h at 254 nm (ASTM E1657-98)
Linearity	> 2.2 AU at 270 nm (ASTM E1657-98)
Time constants	0.1/ 0.2/ 0.5/ 1.0/ 2.0/ 5.0/ 10.0 s
Integration time	Automatic
Maximum data rate	80 Hz (LAN, Analog) 1 channel 10 Hz (RS-232) 1 channel
Input	Error (IN), Start (IN), Autozero, 0-10 V Analog IN
Output	Events 1-3, +5 V, 24 V Value
Analog output	2 x 0 - 5 V scalable, 20 bit, offset adjustable
Control	Digital: LAN, LAN-DHCP, RS-232, remote control; Analog: wavelength control Manual: front panel
Programming	Timed: wavelengths, events, fraction valves, links, wake up (program, link); 19 programs, 99 program lines

GLP	Detailed report including lamp recognition, operating hours, lamp(s) operating hours, step motor operating hours, number of lamp ignitions
Display	LCD
Temperature range	4 - 40 °C, 39.2 - 104 °F
Humidity	below 90 % non condensing
Power supply	100–240 V, 50–60 Hz, 75 W
Power consumption in standby mode	8 W
Dimensions in mm	226 x 135 x 410 mm (width x height x depth)
Weight	6.0 kg
Protection type	IP 20
Height above sea level	maximum 2000 meters

Accessories and Spare Parts

For repeat orders of spare parts use the enclosed packing list. Contact the Technical Support in case there are any questions on spare parts or accessories.

Devices and accessories

Name	Order number
Smartline UV/VIS detector 2550 without flow cell (two lamp version)	A5191XA
Smartline UV detector 2550 without flow cell (one lamp version)	A5190XA
Device manual (English) Device manual (German)	V5193A V5193
Power supply cable 230 V	M1479
RS-232 cable (null modem cable)	M1922
2 integrator cables	M1588
Connector strip, 12-pin	M1971
Stylus (micro lever pusher)	M1246
2 flat ribbon cables	A1467
LAN network cable (Ethernet patch cable CAT5e)	A5255

Re-order

Name	Order number
Complete accessory kit	F5190
Deuterium lamp (one lamp device)	A5193
HBST deuterium lamp for UV-Vis detector (two lamp version)	A5194
Halogen lamp	A5195
Power supply cable	M1479
RS-232 cable (null modem cable)	M1922
Connector strip, 12-pin	M1971
2 x flat ribbon cable (10-pin, 1.5 m)	A1467
Integrator cable (2 x RCA)	M1588
Integrator cable (1 x RCA, 1 x labor plug)	G1023

Available flow cells for the Smartline detector 2550

Analytical flow cells

Technical data		Order number
Path length Connection Inner diameter Volume Material Max. flow rate Max. pressure	10 mm 1/16" 1.1 mm 10 µl Stainless steel with heat exchanger 20 ml/min 300 bar	A4061V2
Path length Connection Inner diameter Volume Material Max. flow rate Max. pressure	3 mm 1/16" 1.0 mm 2 µl Stainless steel 50 ml/min 300 bar	A4042
Path length Connection Inner diameter Volume Material Max. flow rate Max. pressure	3 mm 1/16" 1.0 mm 2 µl PEEK 50 ml/min 30 bar	A4045

Preparative flow cells

Technical data		Order number
Path length Connection Inner diameter Volume Material Max. flow rate Max. pressure	0.5 / 1.25 / 2 mm 1/8" 2.3 mm 1.7 / 4.3 / 6.8 µl Stainless steel 1000 ml/min 200 bar	A4066
Path length Connection Inner diameter Volume Material Max. flow rate Max. pressure	0.5 / 1.25 / 2 mm 1/8" 2.3 mm 1.7 / 4.3 / 6.8 µl PEEK 1000 ml/min 100 bar	A4067
Path length Connection Inner diameter Volume Material Max. flow rate Max. pressure	0.5 / 1.25 / 2 mm 1/4" 4.0 mm 1.7 / 4.3 / 6.8 µl Stainless steel 10000 ml/min 200 bar	A4068
Path length Connection Inner diameter Volume Material Max. flow rate Max. pressure	0.5 mm 1/16" 0.8 mm 3 µl Stainless steel 250 ml/min 200 bar	A4069
Path length Connection Inner diameter Volume Material Max. flow rate Max. pressure	0.5 mm 1/16" 0.8 mm 3 µl PEEK 250 ml/min 100 bar	A4095

U-Z View™ flow cells

Technical data		Order number
Path length	10 mm	A4091
Connection	1/16"	
Inner diameter	0.15 mm	
Volume	0.18 µl	
Material	Stainless steel	
Max. flow rate	0.10 ml/min	
Max. pressure	200 bar	
Path length	10 mm	A4092
Connection	280 µm	
Inner diameter	0.075 mm	
Volume	0.045 µl	
Material	Quartz glass	
Max. flow rate	0.01 ml/min	
Max. pressure	200 bar	

Flow cell replacement parts

- For analytical flow cells

Name	Order number
Lens for A4061V2 flow cell	N0077
Lens for A4061 flow cell	N0001
Compression part	P2633
Compression bushing	P2644
PTFE seal	M1302

- For preparative flow cells

Name	Order number
Fiber optics (quartz glass rod)	N0076
Compression bushing	P2644
PEEK spacer	P2645
Stainless steel cover	P2646
PTFE seal ring	P7003

Test Cells

Technical data		Order number
Test cell	normal	A4123
Test cell	holmium oxide filter	A4126
Test cell	filter stray light	A4146

Legal Information

Warranty Conditions

The manufacturer's warranty for the device is valid for 12 months after the date of dispatch. All warranty claims shall expire in the event that any unauthorized changes are made to the device.

During the warranty period, any components with material or design related defects will be replaced or repaired by the manufacturer free of charge.

This warranty excludes the following:

1. Accidental or willful damage
2. Damage or errors caused by third parties that are not contractually related to the manufacturer at the time the damage occurs
3. Wear parts, fuses, glass parts, columns, light sources, cuvettes and other optical components
4. Damage caused by negligence or improper operation of the device and damage caused by clogged capillaries
5. Packaging and transport damage

In the event of device malfunctions, directly contact the manufacturer:

Wissenschaftliche Gerätebau
Dr. Ing. Herbert Knauer GmbH
Hegauer Weg 38
14163 Berlin, Germany
Phone:+49 30 809727-0
Fax:+49 30 8015010
E-Mail:info@knauer.net
Internet:www.knauer.net

Transportation Damages

The packaging of our devices provides the best possible protection against transportation damage. Check the devices for signs of transportation damages. In case you notice any damage, contact the Technical Support and the forwarder company within three workdays.

Abbreviations and terminology

Here you can find information on the abbreviations and terminology used in this device manual for the Smartline detector 2550.

Terminology	Explanations
GLP	Good Laboratory Practice – quality assurance for laboratories.
Gradient	Time-dependent composition of solvent (mobile phase) on low-pressure or high-pressure side of system.
HPLC	High performance liquid chromatography
Integration time	The integration time determines how fast the detector reacts to changes in absorbance.
IP address	Unique address of transmitter or receiver in local network or Internet (Internet protocol).
Solvent	Mobile phase (eluent) or carrier for liquid chromatography.
Remote	The detector is completely controlled by the chromatography software.
Dead volume	Volume of thin, flexible, stainless steel capillaries between mixing chamber, injector and column as well as between column and detector. The dead volume should as small as possible.
UHPLC	Liquid chromatography in the ultra-high pressure or ultra-high performance range.

Declaration of Conformity

**Manufacturer name
and address** Wissenschaftliche Gerätebau
Dr. Ing. Herbert Knauer GmbH
Hegauer Weg 38
14163 Berlin, Germany

Detector Smartline 2550 Product number E4311XA, E4312XA
complies with the following requirements and product specifications:

- Europe**
- DIRECTIVE 2006/42/EC OF THE EUROPEAN PARLIAMENT AND OF THE COUNCIL of 17 May 2006 on machinery, and amending Directive 95/16/EC (recast)
 - IEC 60799 (June 1998) Electrical accessories - Cord sets and interconnection cord sets
 - IEC 61010-1 (2010 + Corrigendum: 2011) Safety requirements for electrical equipment for measurement, control and laboratory use
 - IEC 61010-2-081 (2001 + A1:2003) Safety requirements for electrical equipment for measurement, control and laboratory use - Part 2-081: Particular requirements for automatic and semi-automatic laboratory equipment for analysis and other purposes
 - IEC 61010-2-010 (2003) Safety requirements for electrical equipment for measurement, control, and laboratory use - Part 2-010: Particular requirements for laboratory equipment for the heating of materials
 - Low voltage directive (2006/95/EC)
 - IEC 61000-3-2 (2005 + A1:2008 + A2:2009) Electromagnetic compatibility (EMC) Part 3-2
 - EMC standard (2004/108/EC)
 - IEC 61326-1 (2012) Electrical equipment for measurement, control and laboratory use – EMC requirements – Part 1: General requirements
 - Directives for an environmentally sound use of electrical and electronic equipment
 - RoHS directives 2002/95/EC (2003) and 2011/65/EU on the restriction of the use of certain hazardous substances in electrical and electronic equipment
 - WEEE directive 2002/96/EC (2003) and 2012/19/EU on waste electrical and electronic equipment

The device was tested with a standard configuration.

Berlin, 2013-10-23



Dr. Alexander Bünz (Managing Director)

The mark of conformity has been applied to the rear panel of the device.

CE

Table of Figures

Fig. 1:	Front view	16
Fig. 2:	Front view of the device with door open	16
Fig. 3:	Rear view	18
Fig. 4:	installing the flow cell	20
Fig. 5:	path length of a preparative flow cell	21
Fig. 6:	Spring strip	23
Fig. 7:	Terminal strip Event and remote control	23
Fig. 8:	Cabling system LAN	28
Fig. 9:	Display and keys	31
Fig. 10:	Structure of the Setup menu	36
Fig. 11:	Structure of the GLP menu	41
Fig. 12:	Creating a program	44
Fig. 13:	Running a program	45
Fig. 14:	Changing a program	46
Fig. 15:	Deleting a program	46
Fig. 16:	Creating a wakeup program	47
Fig. 17:	Creating a link	49
Fig. 18:	Executing a link	50
Fig. 19:	Deleting a link	51
Fig. 20:	Analytical flow cell	55
Fig. 21:	Fiber optics of a preparative flow cell	56
Fig. 22:	Replacing the flow cell	57

Index

A

abbreviations 71
Accessories and Spare Parts 65
Additives 8
ambient conditions 58
AUTO ZERO 17
automatic configuration 6
AVV marking 58

C

Caring 54
CE marking, see Declaration of conformity 72
changing a program 45
changing the optical path length 20
chromatography software 26
Cleaning 54
Connection Problems (LAN) 29
connector strip 22
Contact 13, 53
controlling the detector 31
controlling the GLP menu 40
controlling the link menu 48
controlling the main menu 33
controlling the program menu 43
controlling the scan menu 51
controlling the set up menu 34
creating a link 48
creating a program 43

D

Declaration of Conformity 72
declaration of conformity 72
Decontamination 11
decontamination 58
deleting a link 51
deleting a program 46
disposal 58

E

electrical connections 22
Eluents 8
flammability 10
self-ignition point 10
toxicity 10
error messages, see system messages 59
executing a link 49

F

features 7
flow cells, available 66

H

HPLC 6

I

installation 13
Installation location, see location 13
IP port 29

L

LAN
Connection Problems 29
Router 28
Settings 27
Setup 27
Troubleshooting 29
Location requirements 13

M

maintenance 53
Maintenance Contract 53
manual entry of control signals 25
Manufacturer 70
Modifiers 8

O

Operating range 6
overview of buttons 17

P

performing a wavelength scan 52
Port, see IP port 29
Power connection 14
Power Supply 10
Power supply 14
power cable 10
power strip 10

R

running a program 44

S

safety **9**
Salts **8**
SCAN **17**
selecting the GLP menu **34**
selecting the Link menu **34**
selecting the Program menu **34**
selecting the Setup menu **33**
selection of the wavelength **32**
service tool **53**
Solvents **8**
startup **19**
storage **58**
symbols **12**
system messages **59**

T

technical data **63**
Technical Support **13, 53**
terminal strip
 event and remote control **23**
terminology **71**
Transportation damages **70**
Troubleshooting
 LAN **29**

W

WAKE UP program **47**
Warranty **70**
warranty conditions **72**

© Wissenschaftliche Gerätebau
Dr. Ing. Herbert Knauer GmbH
All rights reserved.
Technical data are subject to change without notice. Please check our
website for latest updates and changes.
Translation of the original German edition of this manual, version 1.0
Last manual update: 2013-10-23
Printed in Germany on environmentally friendly paper from sustainable
forests.

® Smartline are registered trademarks of:
Wissenschaftliche Gerätebau
Dr. Ing. Herbert Knauer GmbH

▶ See up-to-date manuals online:
www.knauer.net/downloads

www.knauer.net

HPLC · SMB · Osmometry

Wissenschaftliche Gerätebau
Dr. Ing. Herbert Knauer GmbH
Hegauer Weg 38
D-14163 Berlin, Germany

Phone: +49 30 809727-0
Telefax: +49 30 8015010
E-Mail: info@knauer.net
Internet: www.knauer.net



© KNAUER 2013 V5193A/0.05/9.13/Koe