

Science with Passion



*Azura*

## Detector UVD 2.1S

### Instructions

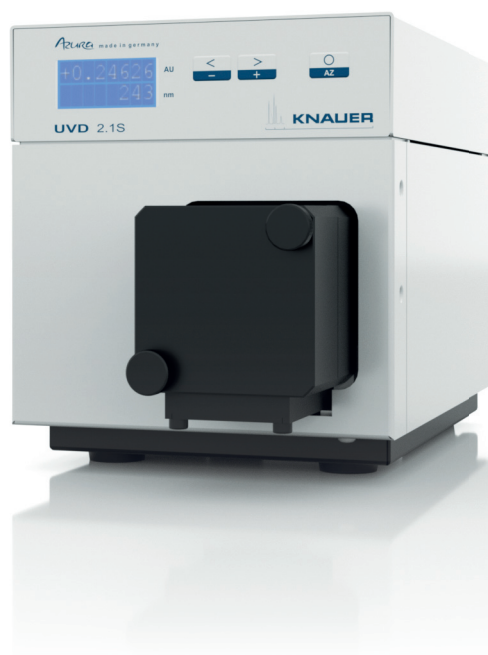

Document No. V6820

# HPLC



**Note:** For your own safety, read the instructions and follow the warnings and safety information on the device and in the instructions. Keep the instructions for future reference.



**Note:** In case you require this instruction in another language, please submit your request including the corresponding document number via e-mail or fax to KNAUER.

**Customer Support:** Phone : +49 30 809727-111 (9-17h Central European Time)  
Fax: +49 30 8015010  
E-mail: [support@knauer.net](mailto:support@knauer.net)  
Languages: German, English

**Publisher:** KNAUER Wissenschaftliche Geräte GmbH  
Hegauer Weg 38  
14163 Berlin  
Germany  
Phone: +49 30 809727-0  
Fax: +49 30 8015010  
Internet: [www.knauer.net](http://www.knauer.net)  
E-mail: [info@knauer.net](mailto:info@knauer.net)

**Version information:** Document number: V6820  
Version number: 5.4  
Release date: March 15, 2023

The information in this document is subject to change without prior notice. For the latest version of the instructions, visit our website: [www.knauer.net/library](http://www.knauer.net/library)



**Copyright:** This document contains confidential information and may not be reproduced without written consent of KNAUER Wissenschaftliche Geräte GmbH.

© KNAUER Wissenschaftliche Geräte GmbH 2023  
All rights reserved.

AZURA® is a registered trademark of  
KNAUER Wissenschaftliche Geräte GmbH.

---

# Table of contents

<b>1. General</b>	<b>1</b>
1.1 About these instructions	1
1.2 Signal words	1
1.3 Additional typographical conventions	1
1.4 Legal information	2
1.4.1 Liability limitation	2
1.4.2 Transport damage	2
1.4.3 Warranty conditions	2
1.4.4 Declaration of conformity	2
<b>2. Basic safety instructions</b>	<b>2</b>
2.1 Intended use	2
2.1.1 Operating ranges	2
2.1.2 Foreseeable misuse	3
2.2 User qualification	3
2.3 Operator responsibility	3
2.4 Personal safety equipment	4
2.5 Working with solvents	4
2.5.1 General requirements	4
2.5.2 Contamination by health-threatening solvents	4
2.5.3 Avoiding leakage	4
2.6 Specific environments	5
2.6.1 Earthquake-endangered areas	5
2.6.2 Explosive environment	5
2.6.3 Cooling room	5
2.7 Maintenance, care and repair	5
2.8 Service request form and decontamination report	6
<b>3. Product information</b>	<b>7</b>
3.1 Features	7
3.2 Flow cells	7
3.3 Scope of delivery	7
3.4 Views	8
3.5 Symbols and signs	9
<b>4. Installation and initial startup</b>	<b>10</b>
4.1 Unpacking	10
4.2 Ambient conditions	10
4.2.1 Operation site	10
4.2.2 Ambient temperature	10
4.2.3 Space requirements	11
4.3 Power supply	11
4.4 Initial startup	12
4.4.1 Inserting the flow cell	12

---

4.5	Setting the optical path length of a preparative flow cell	13
4.6	Connecting capillaries	14
4.7	Switching on the detector	14
4.8	Computer control	16
4.8.1	Setting up LAN	16
4.8.2	Configuring LAN settings	16
4.8.3	Connecting devices with LAN	17
4.8.4	Configuring the router	17
4.8.5	Integrating LAN into the company network	18
4.8.6	Controlling several systems separately in LAN	18
4.9	Setting IP addresses via software	19
4.9.1	Mobile Control: Setting a static IP address	19
4.9.2	Mobile Control: Setting a dynamic IP address via device name	20
4.9.3	Mobile Control: Setting a dynamic IP address via device serial number	20
4.9.4	Firmware Wizard: Setting a static IP address	21
4.9.5	Firmware Wizard: Setting a dynamic IP address	22
4.10	Remote control	23
4.10.1	Connector assignment	23
4.10.2	Connecting the pin header	23
4.10.3	Analog control	24
4.10.4	Ground	25
<b>5.</b>	<b>Operation</b>	<b>26</b>
5.1	Checklist before operation	26
5.2	Software control	26
5.2.1	Chromatography software	26
5.2.2	Mobile Control	26
5.3	Basic operation	27
5.4	Controlling the device	27
5.4.1	Menu structure	28
5.4.2	Choosing a control option	29
5.4.3	Checking or editing LAN settings	29
5.4.4	Activating/deactivating the lamp	30
5.4.5	Adjusting the chromatogram	30
<b>6.</b>	<b>Functionality tests</b>	<b>33</b>
6.1	Installation Qualification (IQ)	33
6.2	Operation Qualification (OQ)	33
<b>7.</b>	<b>Troubleshooting</b>	<b>34</b>
7.1	LAN	34
7.2	Error messages	35
<b>8.</b>	<b>Maintenance and care</b>	<b>36</b>
8.1	Maintenance tasks	36
8.2	Maintenance contract	36
8.3	Replacing the flow cell	37
8.4	Cleaning and caring for the device	37
8.5	Rinsing the flow cell	38

---

---

8.5.1	Cleaning the lens of an analytical flow cell .....	39
8.5.2	Cleaning the light guide of a preparative flow cell.....	40
8.6	Replacing the fiber optics .....	41
<b>9.</b>	<b>Transport and storage.....</b>	<b>42</b>
9.1	Taking the device out of operation .....	42
9.2	Packing the device .....	42
9.3	Transporting the device .....	42
9.4	Storing the device .....	42
<b>10.</b>	<b>Disposal.....</b>	<b>43</b>
10.1	AVV-Marking Germany .....	43
10.2	WEEE registration number .....	43
10.3	Eluents and other operating materials .....	43
<b>11.</b>	<b>Technical data.....</b>	<b>44</b>
11.1	Detection.....	44
11.2	Communication .....	44
11.3	General .....	45
<b>12.</b>	<b>Reorders .....</b>	<b>45</b>
12.1	Devices.....	45
12.2	Software.....	45
12.3	Accessories and spare parts.....	45
12.4	Fiber optic connectors .....	46
12.5	Flow cells .....	46
12.5.1	Analytical flow cells.....	46
12.5.2	Preparative flow cells.....	47
12.5.3	Preparative flow cells - fiber optics .....	48
12.5.4	Test cells .....	48
<b>13.</b>	<b>Chemical compatibility of wetted materials.....</b>	<b>49</b>
13.1	General .....	49
13.2	Plastics .....	49
13.3	Non-metals .....	51
13.4	Metals.....	52

# 1. General

## 1.1 About these instructions

These operating instructions enable the safe and efficient operation of the device. The user must have carefully read and understood these operating instructions before starting any work.





The basic prerequisite for safe operation is compliance with all safety instructions (see „2 Basic safety instructions“, p. 2). In addition to the safety and warning instructions in these operating instructions, the local accident prevention regulations and the national industrial safety regulations apply.

These operating instructions are an integral part of the device. It must be kept in the immediate vicinity of the device and accessible to the user at all times.

You can download these and other instructions from the KNAUER website: [www.knauer.net/library](http://www.knauer.net/library)

## 1.2 Signal words

Possible dangers related to the device are distinguished in personal and material damages.

Symbol	Meaning
	DANGER (red) indicates a highly hazardous situation. If not avoided, it will result in death or serious injury.
	WARNING (orange) indicates a hazardous situation. If not avoided, it could result in death or serious injury.
	CAUTION (yellow) indicates a moderate hazardous situation. If not avoided, it could result in minor or moderate injury.
	NOTICE (blue) is used to address issues which are not related to physical injury.

## 1.3 Additional typographical conventions

- General equal treatment: When persons are described, this document uses the male grammar form to keep the text easy to read. The form has a neutral sense and speaks to people of any gender in the same way.
- Note: Specific information are prefixed with the word "Note" and an information icon.

 | **Note:** This is an example.

## 1.4 Legal information

### 1.4.1 Liability limitation

The manufacturer is not liable for the following issues:

- Non-compliance of these instructions
- Non-observance of necessary safety precautions
- Improper use
- Operation of the device by unqualified personnel (see „2.2 User qualification“, p. 3)
- Use of non-approved spare parts
- Technical changes by the user such as opening the device and unauthorized modifications
- Violations of General Terms and Conditions (GTC)

### 1.4.2 Transport damage

The packaging of our devices provides the best possible protection against transport damage. However, check the packaging for transport damage. In case you notice any damage, inform the Technical Support and the shipping company within three workdays.

### 1.4.3 Warranty conditions

For information on warranty please refer to our general terms and conditions on the website: [www.knauer.net/terms](http://www.knauer.net/terms)

### 1.4.4 Declaration of conformity

The declaration of conformity is enclosed as a separate document with the product and can be obtained online:

[www.knauer.net/en/Support/Declarations-of-conformity](http://www.knauer.net/en/Support/Declarations-of-conformity)

## 2. Basic safety instructions

The device has been developed and constructed in such a way that hazards arising from its intended use are largely excluded. Nevertheless, the following safety instructions must be observed in order to exclude residual hazards.

### 2.1 Intended use

Only use the device for applications that fall within the range of the intended use. Otherwise, the protective and safety equipment of the device could fail.

#### 2.1.1 Operating ranges

The device is intended to be used for chromatographic applications in the laboratory.

## 2.1.2 Foreseeable misuse

Refrain from the use of the device for the following purposes or conditions:

- Medical purposes. The device is not approved as a medical product.
- Operating outside of a laboratory or measurement room. Otherwise, the manufacturer does not guarantee the functionality and safety of the device.
- Operation in potentially explosive areas without special and additional explosion protection. Contact the KNAUER Customer Support for more information.

## 2.2 User qualification

The users are qualified to handle the device if all of the following points apply:

- They have at least a basic knowledge of liquid chromatography.
- They have knowledge about the properties of the used solvents and their health risks.
- They are trained for the special tasks and activities in the laboratory and knows the relevant standards and regulations.
- Due to their technical training and experience, they can understand and carry out all the work described in the operating instructions on the instrument and recognize and avoid possible dangers independently.
- Their ability to react is not impaired by the consumption of drugs, alcohol or medication.
- Participation in the installation of a device or a training by the company KNAUER or an authorized company.

If the users do not meet these qualifications, they have to inform their supervisor.

## 2.3 Operator responsibility

The operator is any person who operates the device himself or leaves it to a third party for use and who bears the legal product responsibility for the protection of the user or third parties during operation.

The obligations of the operator are listed below:

- Knows and follows the applicable work safety regulations
- Identifies hazards arising from the working conditions at the place of use in a risk assessment.
- Sets up operating instructions for the operation of the device.
- Regularly checks whether the operating instructions correspond to the current status of the regulations.
- Clearly regulates and specifies responsibilities for installation, operation, troubleshooting, maintenance and cleaning and set clear rules
- Ensures that all personnel who work with the device have read and understood these operating instructions
- Trains the personnel who work with the device at regular intervals and informs them about the dangers.



- Provides the necessary safety equipment to the employees working with the unit (see section below).

## 2.4 Personal safety equipment

The protective measures required in the laboratory must be observed and the following protective clothing worn during all work on the device:

- Safety glasses with side protection
- Protective gloves in accordance with the prevailing ambient conditions and used solvents (e.g. heat, cold, protection against chemicals)
- Lab coat
- Personalised protective safety equipment which is specified in the particular laboratory.

## 2.5 Working with solvents

### 2.5.1 General requirements

- The user is trained for handling different solvents.
- Note recommended solvents and concentrations in these instructions in order to avoid personal injury or damage to the device. For example, certain chemicals may cause PEEK capillaries to swell or burst (see „13 Chemical compatibility of wetted materials“, p. 49).
- Note that organic solvents are toxic above a certain concentration. For handling hazardous solvents see the following section.
- Mobile phases and samples may contain volatile or combustible solvents. Avoid the accumulation of these substances. Ensure good ventilation of the installation site. Avoid open flames and sparks. Do not operate the instrument in the presence of flammable gases or vapors.
- Only use solvents which do not self-ignite under given conditions. This applies especially to the use of a thermostat where liquids could get onto hot surfaces in the interior.

### 2.5.2 Contamination by health-threatening solvents

- Contamination with toxic, infectious or radioactive substances poses a hazard for all persons involved during operation, repair, sale, and disposal of a device.
- All contaminated devices must be properly decontaminated by a specialist company or the operating company before they can be recommissioned, repaired, sold, or disposed (see „10 Disposal“, p. 43).

### 2.5.3 Avoiding leakage

Risk of electrical shock or short circuit if solvents or other liquids leak into the interior of the device. You can avoid a leakage through the following measures:

- Tightness: Visually check the device or system regularly for leaks.
- Solvent tray: The use of a solvent tray prevents liquids get from the bottles into the inside of the device.
- Eluent lines: Install capillaries and hoses in such a way that, in case of a leak, liquids cannot get into the interior of the devices underneath.

- In case of leakage: Switch off the system. Only take the device into operation if the cause of the leak has been resolved (see „8 Maintenance and care“, p. 36).

## 2.6 Specific environments

### 2.6.1 Earthquake-endangered areas

In earthquake-endangered areas, do not stack more than 3 devices on top of each other. Otherwise there is risk of injury due to falling devices or loose parts.

### 2.6.2 Explosive environment

Never use the system in potentially explosive atmospheres without appropriate protective equipment. For more information, contact the KNAUER Customer Support.

### 2.6.3 Cooling room

You may operate the device in a cooling room. To prevent condensation, note the following instructions:

- Allow the device to acclimatize for min. 3 hours before taking it into operation.
- After taking into operation, the device should stay switched on.
- Avoid temperature fluctuations.

## 2.7 Maintenance, care and repair

- Avoiding electric shock: Before performing any maintenance and service work, disconnect the device from the power supply.
- Tools: Use only tools recommended or prescribed by the manufacturer.
- Spare parts and accessories: Only use original parts and accessories made by KNAUER or a company authorized by KNAUER.
- PEEK fittings: Use PEEK fittings only for a single port or brand-new PEEK fittings in order to avoid dead volume or not exactly fitting connections.
- Column care: Follow KNAUER or other manufacturer's instructions on caring for the columns (see [www.knauer.net/columncare](http://www.knauer.net/columncare))
- Used capillaries: Do not use any used capillaries elsewhere in the system in order to avoid dead volumes, not exactly fitting connections and spreading contamination.
- Safety features: The device may only be opened by the KNAUER Customer Support of KNAUER or any company authorized by KNAUER (see „1.4.1 Liability limitation“, p. 2).
- For more information visit the KNAUER website: [www.knauer.net/hplc-troubleshooting](http://www.knauer.net/hplc-troubleshooting)

---

## 2.8 Service request form and decontamination report

Devices which are shipped without the completed document "Service request form and decontamination report" will not be repaired. If you would like to return a device to KNAUER, make sure to enclose the completed document: [www.knauer.net/servicerequest](http://www.knauer.net/servicerequest)

## 3. Product information

### 3.1 Features

- One of the smallest HPLC detectors on the market.
- A wide range of flow cells for analytical or preparative LC applications with flow rates from 10 µl/min up to 10 l/min.
- Automatic recognition and storage of device-specific information, which are important for Good Laboratory Practice, Operation Qualifications (OQ), for repairing the device.
- Automatic and current diagnosis of the device.
- Control with chromatography software or with the front panel.
- Easy integration of the detector into complex chromatography systems.
- Wavelength change via analog possible.

### 3.2 Flow cells

Various types of flow cells are available to the user. Pay attention to the compatibility of the flow cells. See „12. Reorders“ on page 45.



**Note:** A test cell is preassembled to the device. Before the detector can be used for measurements the test cell has to be replaced by a flow cell. The UVD 2.1S Fiber Optics Version is delivered without a test cell.

### 3.3 Scope of delivery

The following items should be included in the scope of delivery:

- Device AZURA® Detector UVD 2.1S with test cell (test cell not supplied with Fiber Optics Version)
- Power cable
- Power supply unit
- AZURA® UVD 2.1 accessory kit
- AZURA® accessory kit
- Transport protection

Valid documents:

- Instructions
- Installation Qualification (“IQ”)
- Declaration of Conformity

### 3.4 Views

#### Front view

**Legend**

- ① Display
- ② Keyboard
- ③ Flow cell

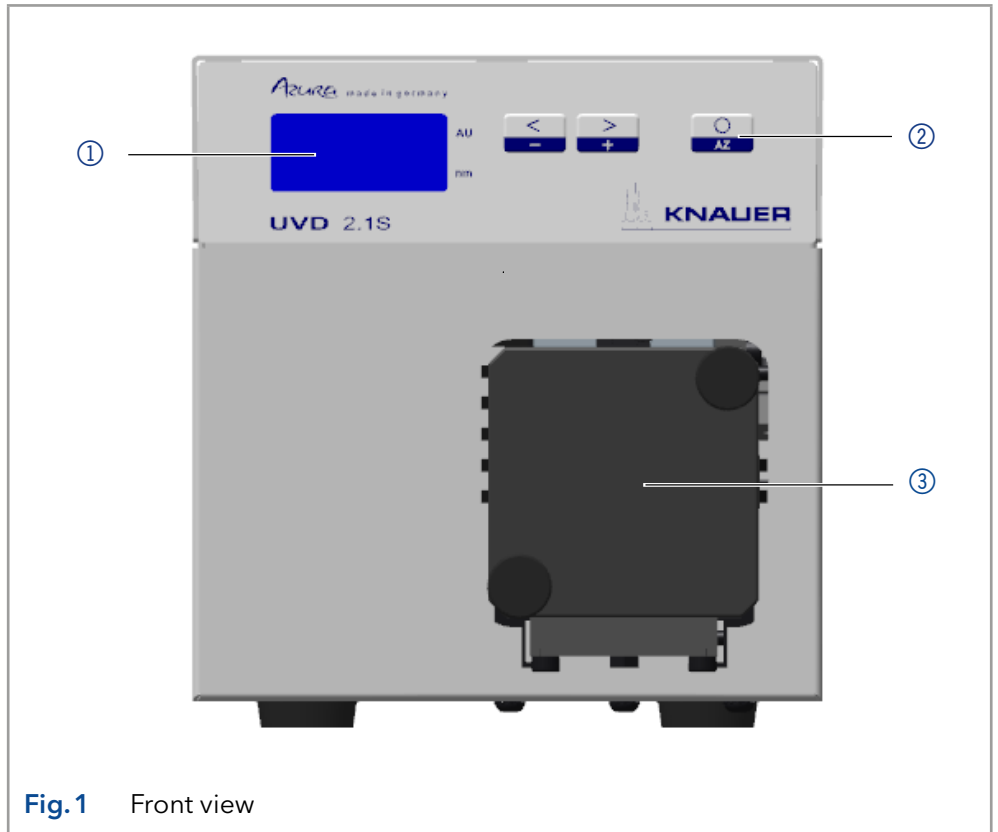
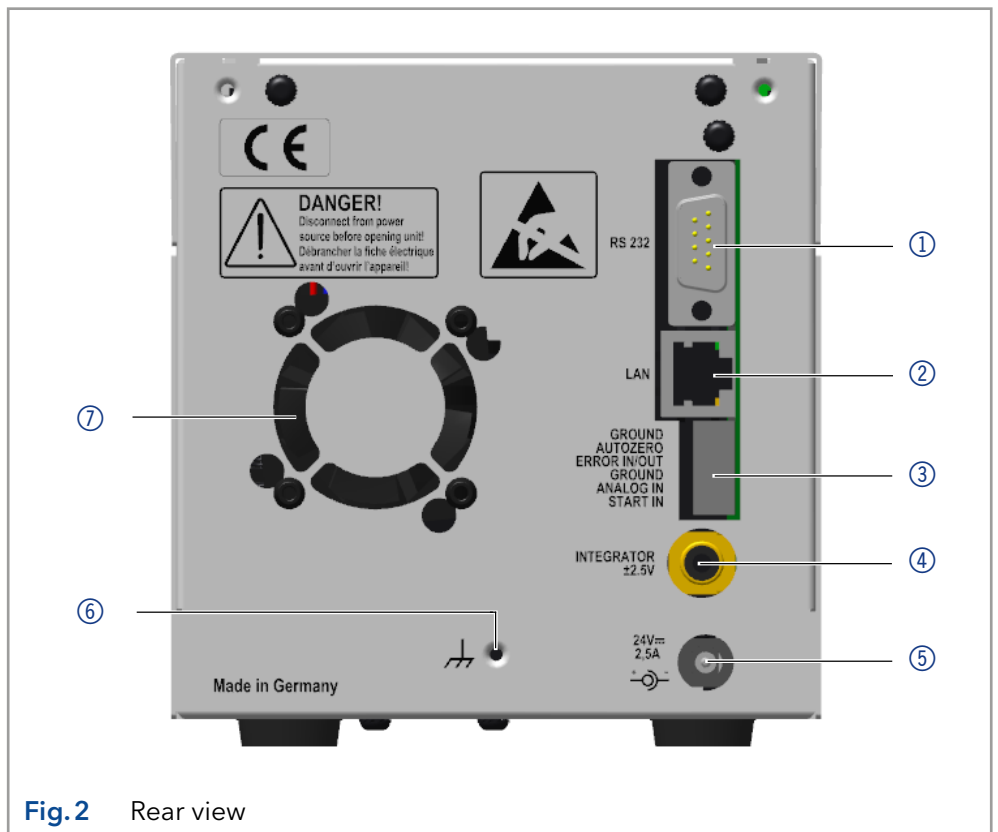

**Fig.1** Front view

#### Rear view

**Legend**





- ① RS-232 port
- ② LAN port
- ③ Pin header
- ④ Integrator output
- ⑤ Connection
- ⑥ Ground
- ⑦ Fan



**Fig.2** Rear view

### 3.5 Symbols and signs

The following symbols and signs can be found on the device:

Symbol	Meaning
	High-voltage hazard
	Electrostatic discharge hazard, damages to system, device, or components can occur.
	A device marked with CE fulfills the product specific requirements of European directives. This is confirmed in a Declaration of Conformity.
	The device complies with the product-specific requirements of the United Kingdom.

## 4. Installation and initial startup

Before you determine the operation site, read chapter (see „11 Technical data“, p. 44). There you will find all device-specific information on power supply, ambient conditions and humidity.



**Note:** The intended use be ensured only if the requirements for ambient conditions of the operating environment are met.

### 4.1 Unpacking

#### Process

#### Procedure

1. Place the packaging in such a way that the lettering on the label is in the correct position.
2. Check the packaging, the device and the accessories for transport damage.
3. Check the scope of delivery. In the event of incomplete delivery, contact Technical Support immediately.
4. When lifting, carrying or moving the device, grab the unit only from below on the sides. Do not hold onto front cover or leak tray, as these parts are loosely attached to the device.

#### Next steps

- Keep the included packing list for repeat orders.
- Keep the original packaging for safe storage or transportation.

### 4.2 Ambient conditions

#### 4.2.1 Operation site

Observe the following requirements for the operation site so that the measurement results are not influenced:

- Place on a firm, level and straight surface.
- Protect against direct sunlight.
- Do not expose to air drafts such as air conditioning systems.
- Do not set up the to other machines that cause floor vibrations.
- Keep from high frequency sources.
- Ensure adequate ventilation (see „4.2.3 Space requirements“, p. 11).
- Avoid temperature fluctuations (see „4.2.2 Ambient temperature“, p. 10).

#### 4.2.2 Ambient temperature

If the ambient temperature of the device is abruptly changed (e.g. when it is installed in a cooling chamber), condensation will form inside the device and may cause damage to the device. Allow the device to acclimate for 3 h, before it is connected to the power supply and taken into operation.

### 4.2.3 Space requirements

- Make sure that the power plug on the power supply (wall socket or power strip) is always accessible, so that the device can be disconnected from the power supply.
- Ensure adequate ventilation around the device, otherwise it may overheat and malfunction:
  - Min. 5 cm distance if another device is set on one side.
  - Min. 10 cm distance if further devices are set on both sides.
  - At least 15 cm to the cooler fan on the rear.
- The mounting of a small device to an AZURA L device with a mounting bracket does not affect the performance of either device. The space requirements specified in both device instructions do not apply in this case.

## 4.3 Power supply

### Power supply requirements

- Failure-free power supply: For failure-free operation, the electrical voltage must be free of fluctuations, residual currents, voltage peaks and electromagnetic interference. The device must receive sufficient voltage and reserve capacity.
- Check voltage: Only connect devices to a power supply whose voltage corresponds to the permissible voltage of the device.
- Power consumption: The nominal power of the connected devices must not exceed 50 % of the highest connected power capacity, since higher currents can flow briefly when the device is switched on.
- Main connection: The electrical power supply at the operation site must be connected directly to the nearest main power connection.
- Grounding: The connectors for the voltage must be grounded accordingly.

### Power supply cables and plugs

- Original parts: For power supply, use the supplied power cable and plug to meet the specifications which are described in the chapter (see „11 Technical data“, p. 44). Detachable power cable cables are not allowed to be replaced with other cable types.
- Country-specific plugs: Before switching on the device, check whether the supplied plug is approved for your country. Overview of the device- and country-specific plug types from KNAUER: [www.knauer.net/plugs](http://www.knauer.net/plugs)
- Power strips: If several devices are connected to one power strip, always consider the maximum power consumption of each device.
- Access to power supply: Make sure that the power plug on the power supply (wall socket or power strip) is always accessible, so that the device can be disconnected easily from the power supply.
- Damaged power supply cables and plugs: For safety reasons, damaged or faulty cables and plugs must not be used to connect the device to the power supply. Replace defective cables and plugs only with KNAUER accessories.



## 4.4 Initial startup



**Note:** Before the detector is ready for use, a flow cell must be installed. Before installing the flow cell, the optical path length in the flow cell can be changed. The optimal path length depends on the type and the quantity of the sample.

### 4.4.1 Inserting the flow cell



**Note:** The test cell is used during operation qualifications and must be stored.

- Prerequisite**
- Detector is switched off.
  - Power plug is disconnected from the device.

	Steps	Figure
<b>Procedure</b>	<ol style="list-style-type: none"> <li>1. Unscrew the 2 knurled-head screws ①.</li> <li>2. Pull out the slide ②.</li> <li>3. Remove the test cell.</li> </ol>	
	<ol style="list-style-type: none"> <li>4. Insert the flow cell ④ into the slide.</li> <li>5. Push the slide ③ into the detector.</li> <li>6. Insert the knurled-head screws and screw tight.</li> </ol>	
<b>Result</b>	The flow cell is assembled.	
<b>Next step</b>	Connect the capillaries.	

## 4.5 Setting the optical path length of a preparative flow cell

Depending on type, the path length is factory set to 2 mm, 3 mm, or 10 mm. For the 2 mm flow cells you can remove the spacers on one or both sides and hence change the path length to 1.25 mm or 0.5 mm.

### ⚠ WARNING

#### Eye injury

Eye irritation by UV light. Bundled UV light can escape from the flow cell or fiber optic cables.

→ Switch off the detector and disconnect it from the power supply.

#### Legend

- ① Threaded ring
- ② Cover
- ③ Spacer
- ④ Seal holder (compression bushing)
- ⑤ Light guide with seal ring

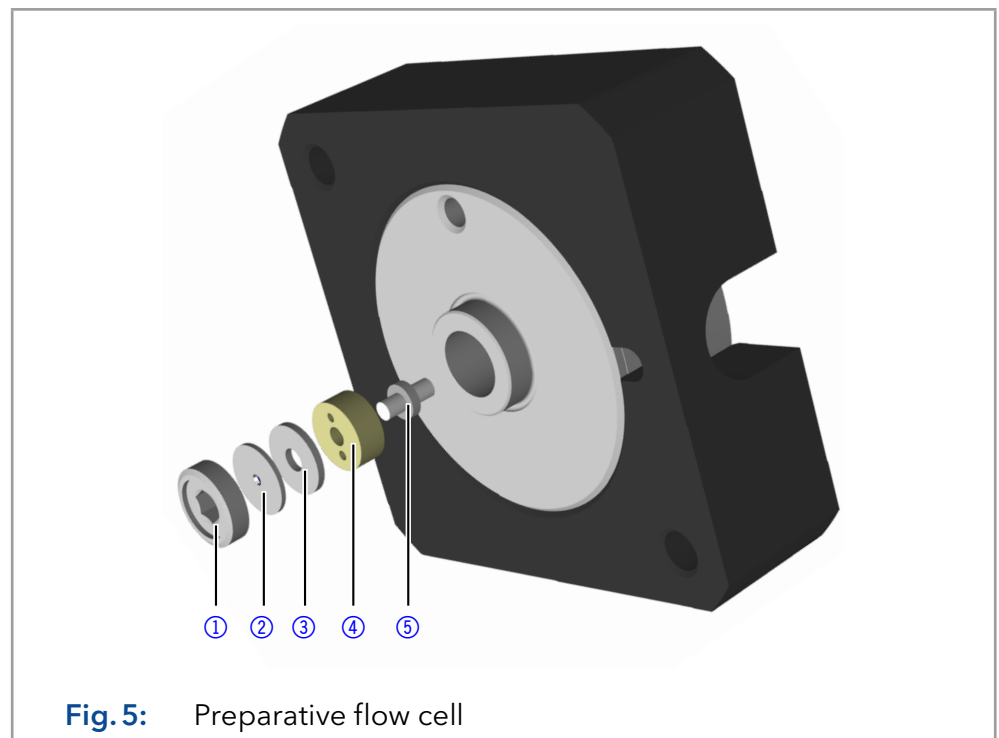

**Fig. 5:** Preparative flow cell

**Prerequisite** Flow cell is removed from the detector.

**Tools** Allen screwdriver, size 3

#### Process

- Procedure**
1. Using the allen screwdriver, loosen the threaded ring ①.
  2. Remove the cover ②.
  3. To shorten the optical path length, remove the spacer ③.  
To enlarge the optical path length, put in one or both spacers.
  4. Insert the cover ②.
  5. Using the allen screwdriver, tighten the threaded ring ①.

**Result** The optical path length is set.

**Next steps** Mount the flow cell onto the detector.

## 4.6 Connecting capillaries

### NOTICE

#### Component defect

Damage to components due to excessive tightening possible.  
Observe the torque of the screw connection.

- Use 5 Nm torque for stainless steel fittings.
- Use 1 Nm torque for PEEK fittings.



**Note:** PEEK fittings withstand a maximum pressure of 400 bar.

**Prerequisite** Flow cell is removed from the detector.

**Tools** Torque wrench

### Procedure

Steps	Figure
-------	--------

1. Push the capillary ② through the fitting ①.
2. Push the clamping ring ③ onto capillary.
3. Manually, screw together the capillary ⑤ and the flow cell ④.  
Tighten the fitting with the wrench.

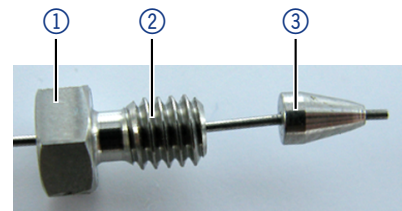

Fig. 6 Capillary fitting

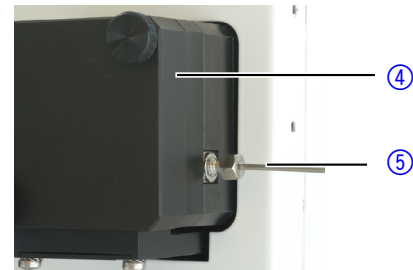

Fig. 7 Capillary and flow cell

**Result** The capillary is connected.

## 4.7 Switching on the detector

### NOTICE

#### Device defect

Changes of the environmental temperature cause condensation inside the device.

- Allow device to acclimate for 3 h before connecting to power supply and taking into operation.

- Prerequisite**
- Installation has been completed.
  - Flow cell is mounted on the detector.
  - Power supply unit is switched off.

**Process****Procedure**

1. Connect the power cable with the device.  
.....
2. Connect the power supply unit with the power cable.  
.....
3. Connect the power supply unit with the power supply.  
.....
4. Using the power supply switch, switch on the detector.  
.....

**Result**

The detector starts its self-calibration. The display shows the progress that has been made. When the self-calibration has finished, the status display appears. If the self-calibration fails, switch the detector off and back on.

## 4.8 Computer control



**Note:** HPLC devices from KNAUER only work with IP addresses, which have been assigned by IPv4. IPv6 is not supported.

This chapter describes how to set up a chromatography system in a local area network (LAN) and how a network administrator can integrate this LAN into your company network. The description applies to the operating system Windows® and all conventional routers.



**Note:** When using PurityChrom®, static IP addresses are needed (see chapter 4.8 on page 16).

### 4.8.1 Setting up LAN

To set up a LAN, we recommend to use a router. That means the following steps are required:

Process	
<b>Procedure</b>	<ol style="list-style-type: none"> <li>1. On the computer, go to the control panel and check the LAN properties.</li> <li>.....</li> <li>2. Hook up the router to the devices and the computer.</li> <li>.....</li> <li>3. Set up the router for the computer network.</li> <li>.....</li> <li>4. Install the chromatography software.</li> <li>.....</li> <li>5. Switch on the device and run the chromatography software.</li> <li>.....</li> </ol>
<b>Next steps</b>	Configure LAN properties (see section 4.8.2).

### 4.8.2 Configuring LAN settings

The LAN uses only one server (which is normally the router) from that the devices automatically receive their IP address.

<b>Prerequisites</b>	<ul style="list-style-type: none"> <li>■ In Windows, power saving, hibernation, standby, and screen saver must be deactivated.</li> <li>■ In case you use an USB-to-COM box, the option "Allow the computer to turn off this device to save power" in the Device Manager must be deactivated for all USB hosts.</li> <li>■ Applies to all LAN devices: Disable the setting for the network adapter in Device Manager "Allow the computer to turn off this device to save power".</li> </ul>
----------------------	---------------------------------------------------------------------------------------------------------------------------------------------------------------------------------------------------------------------------------------------------------------------------------------------------------------------------------------------------------------------------------------------------------------------------------------------------------------------------------------------

Process	
<b>Procedure</b>	<ol style="list-style-type: none"> <li>1. In Windows, open &lt;Network and Sharing Center&gt;.</li> <li>.....</li> <li>2. Double-click on &lt;LAN connection&gt;.</li> <li>.....</li> <li>3. Click on the button &lt;Properties&gt;.</li> <li>.....</li> <li>4. Select &lt;Internet Protocol version 4 (TCP/IPv4)&gt;.</li> <li>.....</li> <li>5. Click on the button &lt;Properties&gt;.</li> <li>.....</li> </ol>

**Process**

6. Check the settings in the tab <General>. The correct settings for the DHCP client are:
  - a) Obtain an IP address automatically
  - b) Obtain DNS server address automatically
7. Click on the button <OK>.

**Next steps** Connect devices (see section 4.8.3).

### 4.8.3 Connecting devices with LAN

A router ② has several LAN ports ③ and one WAN port ④ that can be used to integrate the LAN into a wide area network (WAN), e.g. a company network or the Internet. In contrast, the LAN ports serve to set up a network from devices ① and a computer ⑤. To avoid interference, we recommend operating the chromatography system separately from the company network.



**Note:** You will find patch cables for each device and the router in the accessories kit. To connect the router to a LAN, an additional patch cable is required, which is not supplied within the scope of delivery.

#### Legend

- ① Devices
- ② Router
- ③ LAN ports
- ④ WAN/Internet connection
- ⑤ Computer

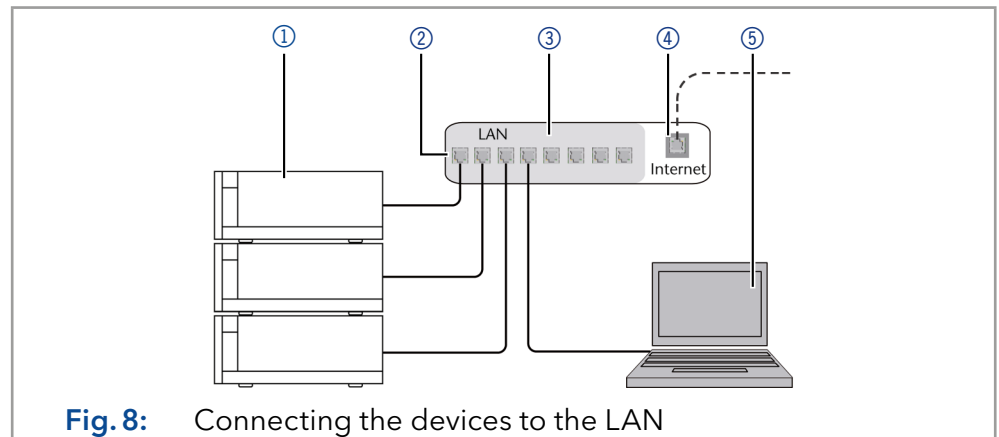

**Fig. 8:** Connecting the devices to the LAN

- Prerequisites**
- The computer is switched off.
  - There is a patch cable for each device and the computer.

**Process**

- Procedure**
1. Use the patch cable to connect the router and the computer. Repeat this step to connect all devices.
  2. With additional patch cables, connect all devices individually with the router.
  3. Use the power supply to connect the router to the mains power system.

**Next steps** Set the router properties (see section 4.8.4).

### 4.8.4 Configuring the router

The router is preset at the factory. Information about address, user name and password is noted in the router manual: [www.knauer.net/router](http://www.knauer.net/router)

	<b>Process</b>
<b>Procedure</b>	<ol style="list-style-type: none"> <li>1. To open the router configuration, start your Internet browser and enter the IP address (does not apply for all routers).</li> <li>2. Enter user name and password.</li> <li>3. Configure the router as DHCP server.</li> <li>4. In the router configuration, check the IP address range and make changes if necessary.</li> </ol>



**Note:** If the IP address range has been changed, it is essential to note this information on the router.

**Result** Once the router has assigned IP addresses to all devices, the chromatography software can be used to remotely control the system.

### 4.8.5 Integrating LAN into the company network

A network administrator can integrate the LAN into your company network. In this case you use the WAN port of the router.

**Prerequisites**

- There is a patch cable for the connection.

	<b>Process</b>
<b>Procedure</b>	<ol style="list-style-type: none"> <li>1. Make sure that there is no overlap between the IP addresses of the router and the corporate network.</li> <li>2. In case of an overlap, change the IP address range of the router.</li> <li>3. Use the patch cable to connect the router WAN port to the company network.</li> <li>4. Restart all devices, including the computer.</li> </ol>

**Result** The LAN is now integrated into the company network.

### 4.8.6 Controlling several systems separately in LAN

Devices connected to a LAN communicate through ports, which are part of the IP address. If more than one chromatography systems are connected to the same LAN and you plan on controlling them separately, you can use different ports to avoid interference. Therefore, the port number for each device must be changed and this same number must be entered into the device configuration of the chromatography software. We recommend to use the same port number for all devices in the same system.



**Note:** The port is set to 10001 at the factory. You must use the same numbers in the device configuration of the chromatography software as in the device, otherwise the connection fails.

	<b>Process</b>
<b>Procedure</b>	<ol style="list-style-type: none"> <li>1. Find out port number and change it on the device.</li> <li>2. Enter the port number in the chromatography software.</li> </ol>

**Result** The connection is established.

## 4.9 Setting IP addresses via software



**Note:** Check the IT security standards for your lab before intervening in the LAN settings.

**PurityChrom®** Static IP addresses are required to run certain chromatography software, e.g. Purity Chrom®. For a comprehensive overview on how to set static IP addresses for PurityChrom®, refer to the document „PurityChrom® Installation Guide“ on the PurityChrom® installation CD.

For Mobile Control and Firmware Wizard, it is possible to set a fixed (static) or dynamic (DHCP) IP address via software.

### 4.9.1 Mobile Control: Setting a static IP address



**Note:** The device is preset to a dynamic address (DHCP). To ensure a constant LAN connection between the chromatography software and the instrument, we recommend switching the instrument to a static IP address for certain applications. More information about LAN settings can be found in the [Mobile Control Software Instructions](#) (document no. V6851-1).

- Prerequisites**
- The device is switched on.
  - Mobile Control is installed and running.
  - The connection between Mobile Control and the device has been established.

#### Process

#### Procedure

1. In Mobile Control, click <Settings>.
2. On the <General> tab, choose the device name.
3. In <Network Settings>, choose the setting <Static> ①.
4. Enter the IP address into the text box <IP Address> ②.
5. If necessary, change the subnet mask and the gateway ③.
6. Click in the top right corner.
7. Restart the device (recommended).

#### Legend

- ① IP address mode
- ② Text box for IP address
- ③ Text field for subnet mask/gateway

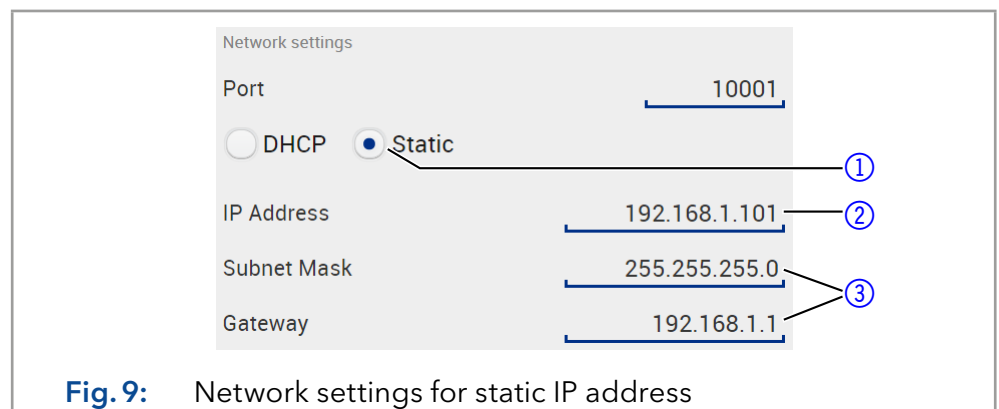

**Fig. 9:** Network settings for static IP address



**Result** The device is now accessible via the static IP address.



## 4.9.2 Mobile Control: Setting a dynamic IP address via device name

- Prerequisites**
- The device is switched on.
  - Mobile Control is installed and running.
  - The connection between Mobile Control and the device has been established.

### Process

- Procedure**
1. In Mobile Control, click  <Settings>.
  2. On the <General> tab, choose the device.
  3. In <Network Settings>, choose the setting <DHCP> .
  4. Click  in the top right corner.
  5. Restart the device (recommended).

### Legend

-  IP address mode

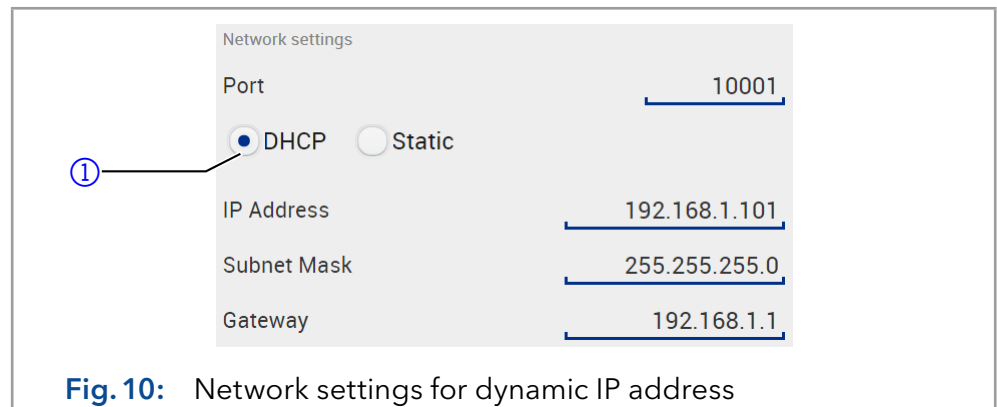

**Result** The device is now accessible via a dynamic IP address.

## 4.9.3 Mobile Control: Setting a dynamic IP address via device serial number

- Prerequisites**
- The device is switched on.
  - Mobile Control is installed and running.
  - The connection between Mobile Control and the device has been established.

### Process

- Procedure**
1. In Mobile Control, click  <Settings>.
  2. In <Network Settings>, click <Reset>. The windows <Reset communication settings> opens.
  3. Enter the serial number of the device into the text field.
  4. Click <OK>. The device is now reset to default settings.
  5. Restart the device (recommended).

**Result** The device is now accessible via a dynamic IP address.

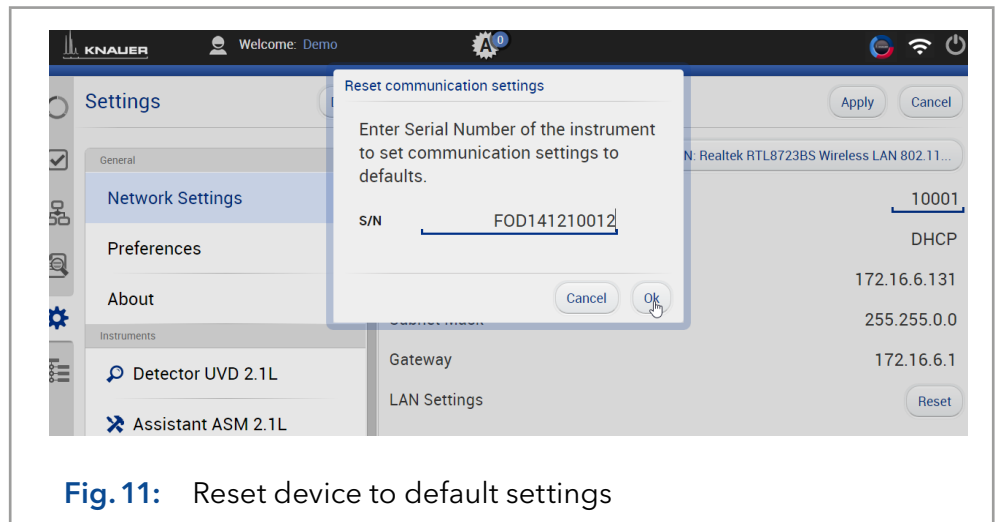

**Fig. 11:** Reset device to default settings

#### 4.9.4 Firmware Wizard: Setting a static IP address



**Note:** More information about LAN settings can be found in the Mobile Control Software Instructions in the chapter "Firmware Wizard" (document no. V6851-1).

#### Legend

- ① Text box for serial number of the device
- ② Setting IP address manually
- ③ Text box for IP address
- ④ Text box for subnet mask & gateway
- ⑤ Confirm changes

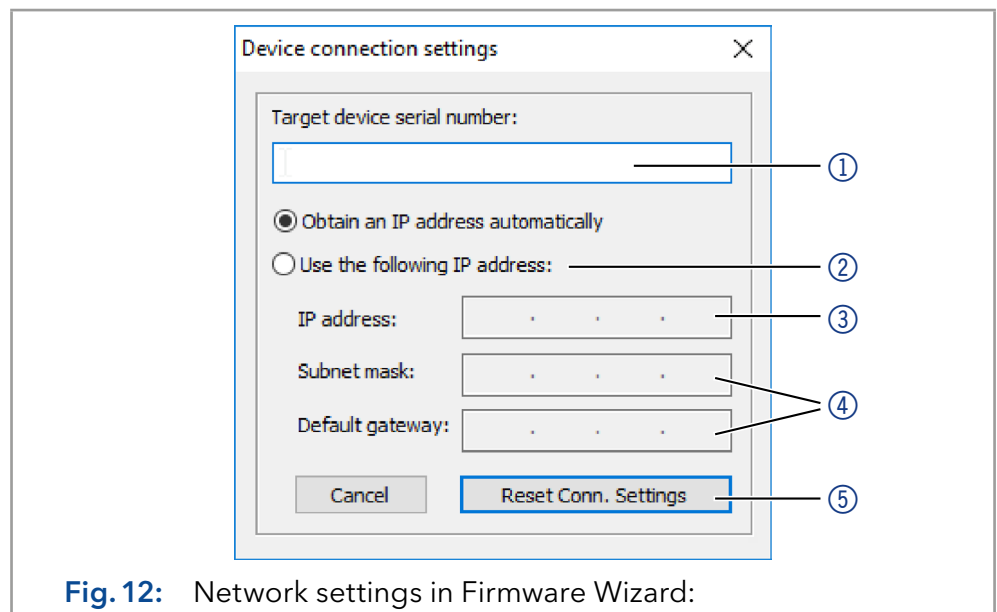

**Fig. 12:** Network settings in Firmware Wizard:

#### Prerequisites

- The device is switched on.
- Firmware Wizard is installed and running.
- The connection between Firmware Wizard and the device has been established.

#### Process

#### Procedure

1. In Firmware Wizard, click <Reset LAN Settings...>.
2. The window <Device connection settings> opens. Enter serial number of the device into the text field <Target device serial number> ①.
3. Select option <Use the following IP address> ②.
4. Enter the IP address into the text field <IP address> ③.
5. Optionally, adjust subnet mask and gateway ④.

**Process**

6. Click <Reset Conn. Settings> ⑤ to accept changes.
7. Restart the device (recommended).

**Result** The device is now accessible via the static IP address.

### 4.9.5 Firmware Wizard: Setting a dynamic IP address

- Prerequisites**
- The device is switched on.
  - Firmware Wizard is installed and running.
  - The connection between Firmware Wizard and the device has been established.

**Process**

- Procedure**
1. In Firmware Wizard, click <Reset LAN Settings...>.
  2. The window <Device connection settings> opens. Enter serial number of the device into the text field <Target device serial number> ①.
  3. Select option <Obtain an IP address automatically> ②.
  4. Click <Reset Conn. Settings> ⑤ to accept changes.
  5. Restart the device (recommended).

**Result** The device is now accessible via a dynamic IP address.

## 4.10 Remote control

The pin header is used for remote control. The single ports transport start, control and error signals.

### 4.10.1 Connector assignment

Port	Function
GROUND	Reference point of the voltage at the signal inputs.
AUTOZERO	A signal (short circuit to GROUND) sets the measuring signal to zero.
ERROR IN/OUT	<p>The input/output has in idle state + 5V, which is for both operating directions INACTIVE. If the external connection is pulled to 0V, the ERROR IN becomes ACTIVE. An internal error in the detector causes this port to be drawn to 0V from the device itself ERROR OUT becomes ACTIVE.</p> <p>A possible external wiring with pull-ups is not necessary.</p> <ul style="list-style-type: none"> <li>■ IN: After receiving a signal (short circuit to GROUND) from an external device, an error message appears and the device stops.</li> <li>■ OUT: An error signal is active for as long as an error is displayed e.g. the lamp does not start.</li> </ul>
GROUND	Reference point for external analog control of the detector.
ANALOG IN	Allows external analog control of the detector when the option ANALOG has been selected in the SETUP menu. The control voltage must be applied against GROUND.
Start IN	After receiving a signal (short circuit to GROUND) from an external device, the device starts. If controlled via software, an electronic trigger is sent via LAN.

### 4.10.2 Connecting the pin header

To control one device through another, the pin header is used. To use remote control, you have to connect cables to the pin header. The single ports are used to exchange control signals.

- Prerequisites**
- The device is switched off.
  - The power plug is disconnected from the device.
- Tools**
- Operating tool

**NOTICE****Electronic defect**

Electrostatic discharge can destroy the electronics.

→ Wear a protective bracelet against electrostatic discharge and ground.

**NOTICE****Electronic defect**

Connecting cables to the multi-pin connector of a switched on device causes a short circuit.

→ Turn off the device before connecting cables.

→ Pull the power plug.

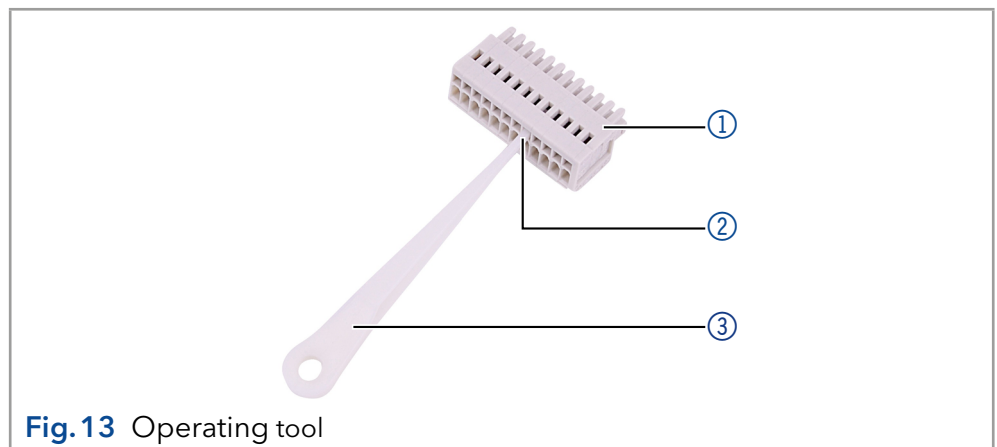

**Fig.13** Operating tool

**Process**

1. Insert the operating tool ③ in an upper small opening at the front of the pin header ①.
2. Insert the cable into the opening ② underneath the inserted operating tool.
3. Pull out the operating tool.

**Next steps**

- Check whether the cables are tightly attached.
- Press the pin header onto the connector.
- Finish the installation.
- Bring the device into operation.

**4.10.3 Analog control**

Using the analog port, you can control the wavelength by changing the applied voltage. A Mobile Control is required in order to select the option ANALOG in the SETUP menu.

**Example**

To use the analog port for controlling the detector, you have to set a zero point and enter a scaling value.

- Zero point at 0 V = 000 nm
- Scaling: 100 nm per Volt

If 5 V voltage is applied, the wavelength is 500 nm.

## 4.10.4 Ground

Voltages, which may influence the measuring result, can be discharged if the device is connected to a grounded device, e. g., a thermostat.

### Prerequisites

- The device is switched off.
- The power plug is disconnected from the device.

### Tools

- Operating tool



**Note:** When connected to a 24 V power supply, the detector is not grounded.

### Steps

1. Remove 5 mm of insulation from the ends of the cable.
2. Using the depressor tool, open the port Ground on the pin header.
3. Insert the first cable end.

### Figure

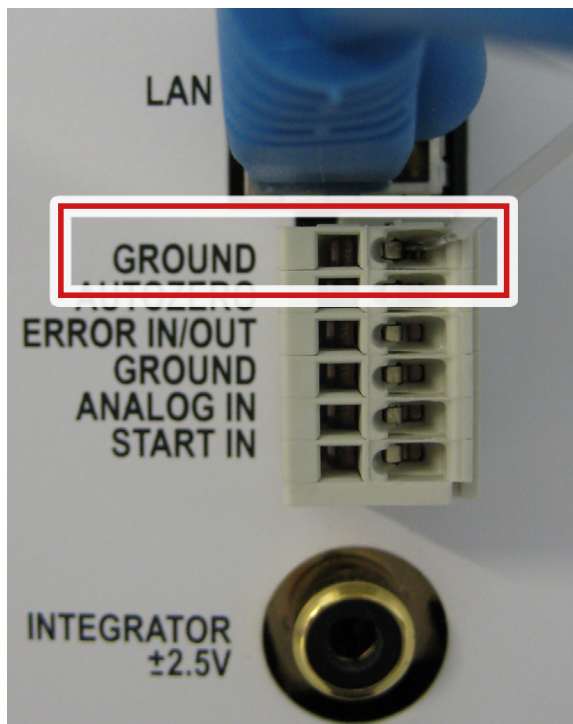

Fig. 14 Ground port

4. Connect the second cable end to the port Ground on the pin header of a grounded 220 V KNAUER device.

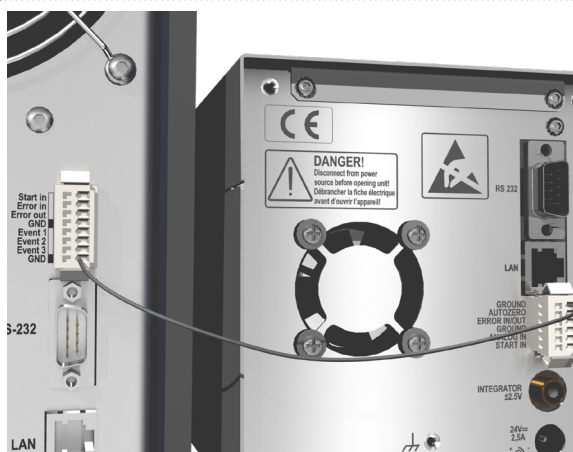

Fig. 15 Connecting with other device

## 5. Operation



**Note:** Before the detector is ready to use for measurements, a flow cell must be installed. You can change the optical path length of a preparative flow cell before assembling the flow cell. The optimal path length depends on type and quantity of the sample.

### 5.1 Checklist before operation

- Device is in a location which suits the ambient conditions and space requirements specified in section „Ambient conditions“ on (see „4.2.2 Ambient temperature“, p. 10).
- The power connection of the detector is plugged in (see „4.3 Power supply“, p. 11).

If the detector is part of a HPLC system, the following must be observed:

- The network connection to the router is established (see „4.8.4 Configuring the router“, p. 17).
- A chromatography software has been installed by KNAUER or a company authorized by KNAUER.
- Capillaries from the column to the UV detector and capillaries from the detector to the waste bottle are securely attached.

### 5.2 Software control

A device can be operated in several ways:

- with keyboard on the front panel
- with chromatography software
- with Mobile Control



**Note:** It is not possible to use two operating methods simultaneously. If the device is connected to the software, it cannot be controlled via Mobile Control. The device status can however be monitored.

#### 5.2.1 Chromatography software

To control the device with chromatography software, it must be connected to the computer through the LAN interface.

Devices can be controlled with e. g. OpenLAB® EZChrom edition version A.04.05 or higher, ChromGate version 3.3.2 or higher and ClarityChrom® version 3.0.7 or higher, Chromeleon® 7.2 and PurityChrom® version 5.07.039 or higher.

You will find a detailed description on the chromatography software in the software instructions.

#### 5.2.2 Mobile Control

The Mobile Control is a device control software which can be installed on your tablet. To control the device using the Mobile Control, connect the computer or tablet with operating system Windows 10 to a wireless LAN router. Data transfer between device and Mobile Control is actualized

through wireless LAN. You find a detailed description on Mobile Control in its accompanying instructions.

## 5.3 Basic operation

The status display shows the values for absorption and wavelength.

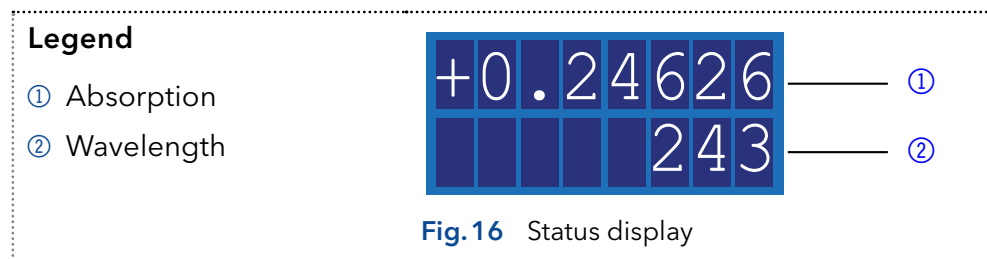

**Note:** When the deuterium lamp has been turned off or is heating, the absorption values are substituted by OFF or HEAT, respectively.

There are 3 buttons on the detector that can be used for basic operation. Using the buttons, you can monitor the device and change the settings.



**Note:** To avoid falsifying measuring values, KNAUER recommends to press the Autozero button before every measurement and after exchanging eluents.

Function	Figure
<ul style="list-style-type: none"> <li>Keep left arrow key pressed. Scroll using the right arrow key.</li> </ul>	
<ul style="list-style-type: none"> <li>Press any of the arrow keys to set values and to change settings.</li> </ul>	
<ul style="list-style-type: none"> <li>Initiating an autozero: Absorption is set to 0.000.</li> </ul>	

**Fig. 17** Arrow keys

**Fig. 18** Autozero

## 5.4 Controlling the device

You can control the device using the buttons on the front panel. Handle the buttons in the following manner:

- Keep left arrow key pressed. Scroll through the menu using the right arrow key.
- Let go of left arrow key and, using both arrow keys, set the values.



### 5.4.1 Menu structure

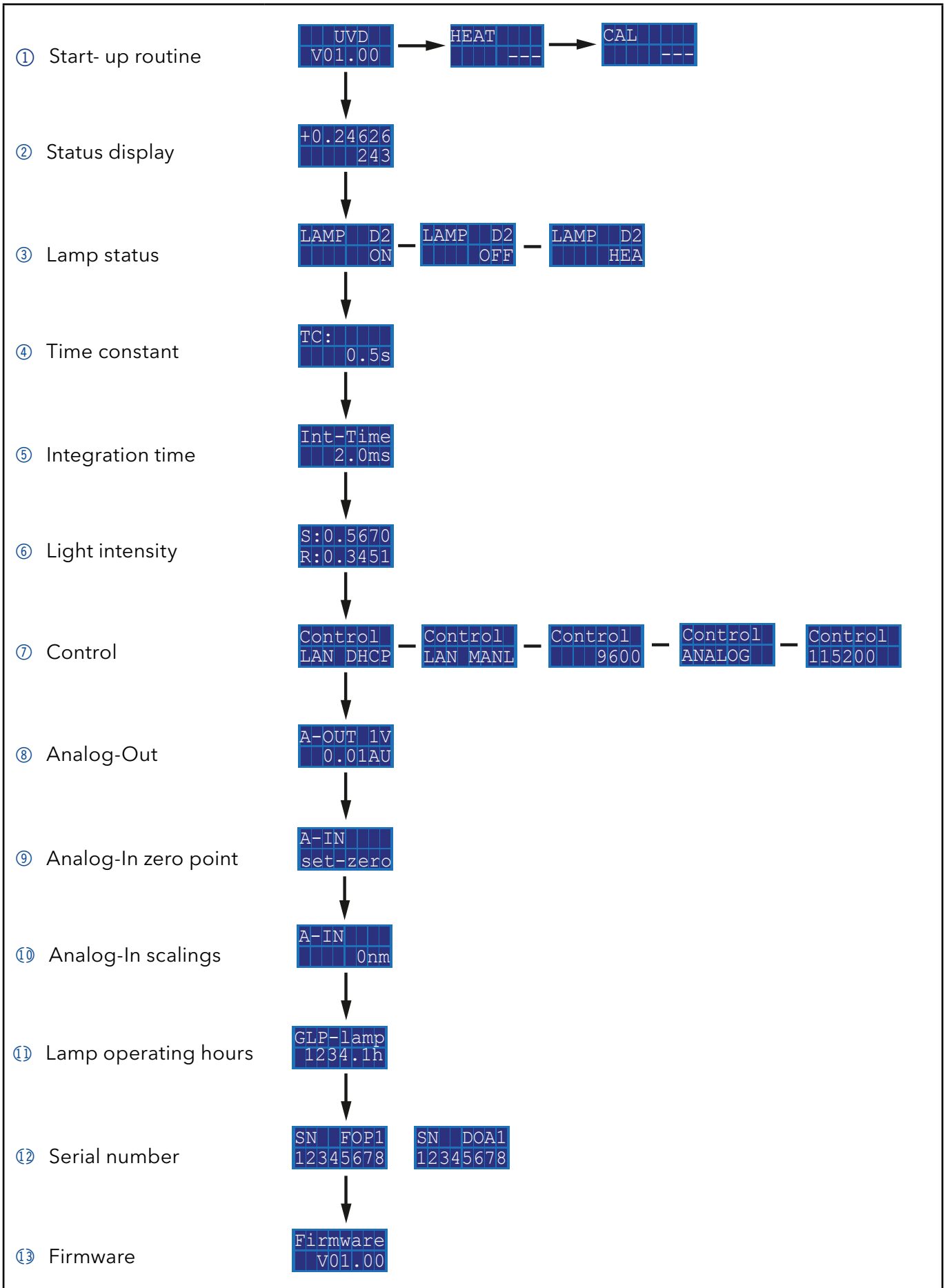

## 5.4.2 Choosing a control option

Choose between analog or digital ports to control the device accordingly.

- LAN DHCP: Control with LAN, IP address is obtained automatically (recommended)
- LAN MANL: Control with LAN via a static IP address
- RS-232 9600: Serial port for cables longer than 2 m
- RS-232 115200: Serial port for cables with up to 2 m length
- ANALOG: Wavelength selection via applied voltage





- Prerequisite**
- Where applicable: a physical connection has been established.
  - Status display is active.

Process	Figure
<p><b>Procedure</b></p> <ol style="list-style-type: none"> <li>1. Keep left arrow key pressed. Scroll using the right arrow key until the correct display appears.</li> </ol> <hr/> <ol style="list-style-type: none"> <li>2. Let go of left arrow key.</li> </ol> <hr/> <ol style="list-style-type: none"> <li>3. Using both arrow keys, choose a port.</li> </ol> <hr/>	 <p><b>Fig. 19</b> Control option</p>

**Result** When setting is finished, the status display appears.

## 5.4.3 Checking or editing LAN settings



The current IP address, subnet mask, gateway and port settings of your device can be checked via the main menu. This is possible for LAN DHCP and LAN MANL control options. For LAN MANL it is furthermore possible to edit your LAN settings. The following representations are used in the LAN menu:

			
IP address	Subnet mask	Gateway	IP port

- Prerequisite**
- Where applicable: a physical connection has been established.
  - Status display is active.



**Note:** Each number 1-4 in IP address, subnet mask and gateway stands for 3 digits, e. g. 1 stands for the first 3 digits, 2 for the next 3 digits, etc.

Process	Figure
<p><b>Procedure</b></p> <ol style="list-style-type: none"> <li>1. Select your desired control option (see „5.4.2 Choosing a control option“, p. 29).</li> </ol> <hr/> <ol style="list-style-type: none"> <li>2. Press autozero to enter into the LAN menu.</li> </ol> <hr/>	 <p><b>Fig. 20</b> Example for control option</p> 

**Process****Figure**

3. Keep left arrow key pressed. Press right arrow key to scroll through the IP address, subnet mask, gateway and IP port submenus.
4. Let go of left arrow key.
5. Using both arrow keys, edit the settings.



**Fig. 21** Example for submenu

### 5.4.4 Activating/deactivating the lamp

The status display shows not only absorption and wavelength, but also indicates the status of the lamp.

- HEA: Lamp is heating.
- OFF: Lamp is deactivated.
- ON: Lamp is activated.

**Prerequisite** Status display is active.

**Process****Figure****Procedure**

1. Keep left arrow key pressed. Press right arrow key until the correct display appears.
2. Let go of left arrow key.
3. Using both arrow keys, activate or deactivate the deuterium lamp.



**Fig. 22** Display lamp

**Result** When setting is finished, the status display appears.

### 5.4.5 Adjusting the chromatogram

To get a better representation of the chromatogram, you can either smooth the output signal or adjust the voltage/absorption ratio.

#### Smoothing output signal

To smooth the output signal, you have to change the values of the time constant.

- 0.00 s, 0.02 s, 0.05 s, 0.1 s, 0.2 s, 0.5 s, 1 s, 2 s

**Prerequisite** Status display is active.

**Process****Figure****Procedure**

1. Keep left arrow key pressed. Press right arrow key until the correct display appears.
2. Let go of left arrow key.
3. Using both arrow keys, set a value.



**Fig. 23** Display time constant

**Result** When setting is finished, the status display appears.

### Adjusting V/AU ratio

By assigning different absorption values to a voltage value of 1 V, you can stretch or compress the chromatogram. You can choose the absorption value out of 8 values:

- 0.01 AU
- 0.05 AU
- 0.1 AU
- 0.2 AU
- 0.5 AU
- 1 AU
- 2 AU
- 10 AU

**Prerequisite** Status display is active.

Process	Figure
<p><b>Procedure</b></p> <ol style="list-style-type: none"> <li>1. Keep left arrow key pressed. Press right arrow key until the correct display appears.</li> <li>2. Let go of left arrow key.</li> <li>3. Using both arrow keys, set a value.</li> </ol>	 <p><b>Fig. 24</b> Display Analog-out</p>

**Result** When setting is finished, the status display appears.

### Display operating hours

**Prerequisite** Status display is active.

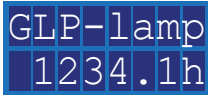
Process	Figure
<p><b>Procedure</b></p> <ol style="list-style-type: none"> <li>1. Keep left arrow key pressed. Press right arrow key until the correct display appears.</li> <li>2. Let go of left arrow key.</li> </ol>	 <p><b>Fig. 25</b> Display lamp operating hours</p>

**Result** The number of operating hours is displayed and afterwards the status display appears.

**Next steps** If the deuterium lamp has been operating for approximately 2000 hours consider lamp replacement.

### Using the analog port

To use the analog port for setting the wavelength of the detector, you have to set a zero point and enter a scaling value.

### Setting the zero point

The zero point is predefined by the applied voltage.

**Prerequisite**

- Device has been connected to GROUND.
- ANALOG port has been selected.

	Process	Figure
<b>Procedure</b>	<ol style="list-style-type: none"> <li>1. Keep left arrow key pressed. Press right arrow key until the correct display appears.</li> <li>2. Let go of arrow keys.</li> <li>3. Press autozero.</li> </ol>	
		<b>Fig. 26</b> Analog-In set zero

**Result** The applied voltage is set as the zero point and is adjusted to 0 nm wavelength.

### Entering a scaling value

It is recommended to set 500 nm at an applied voltage of 5 V.

- Device has been connected to GROUND.
- ANALOG port has been selected.
- Zero point has been set.

	Process	Figure
<b>Procedure</b>	<ol style="list-style-type: none"> <li>1. Apply voltage.</li> <li>2. Keep left arrow key pressed. Press right arrow key until the correct display appears.</li> <li>3. Let go of left arrow key.</li> <li>4. Using the arrow keys, set a value. Do not press autozero.</li> </ol>	
		<b>Fig. 27</b> Analog-In scaling

**Result** When setting is finished, the status display appears.

## 6. Functionality tests



**Note:** Standard processes regarding IQ and OQ in single devices may be handled differently in individual cases.

### 6.1 Installation Qualification (IQ)

The customer may request the Installation Qualification, which is free of charge. In case of a request, the technical support of KNAUER or a provider authorized by KNAUER performs this functionality test during the installation.

The Installation Qualification is a standardized document that includes the following:

- confirmation of flawless condition at delivery
- check if the delivery is complete
- certification on the functionality of the device

You can either use the IQ document attached to this instruction manual or download a digital version from our website:



### 6.2 Operation Qualification (OQ)

The Operation Qualification includes an extensive functionality test according to KNAUER standard OQ documents. The Operation Qualification is a standardized document and free of charge. It is not part of the delivery. Please contact the technical support in case of a request.

The Operation Qualification includes the following:

- definition of customer requirements and acceptance terms
- documentation on device specifications
- device functionality check at installation site

**Test intervals** To make sure that the device operates within the specified range, you should test the device regularly. The test intervals depend on the usage of the device.

**Execution** The test can be carried out either by the technical support of KNAUER or by a provider authorized by KNAUER (for a fee). For further information visit our website:



## 7. Troubleshooting

First measures:

- Check all cables and fittings.
- Check if air has gotten into the supply lines.
- Check the device for leakages.

Further measures:

- Compare occurring errors with the list of possible errors (see below).
- Contact the Customer Support.

### 7.1 LAN

Go through the following steps, in case no connection between the computer and the devices can be established. Check after each step if the problem is solved. If the problem cannot be located, call the Technical Support.

1. Check the status of the LAN connection in the Windows task bar:



If no connection was established, test the following:

- Is the router switched on?
  - Is the patch cable connected correctly to the router and the computer?
2. Check the router settings:
    - Is the router set to DHCP server?
    - Is the IP address range sufficient for all the connected devices?
  3. Check all connections:
    - Are the patch cable connected to the LAN ports and not the WAN port?
    - Are all cable connections between devices and router correct?
    - Are the cables plugged in tightly?
  4. If the router is integrated into a company network, pull out the patch cable from the WAN port.
    - Can the devices communicate with the computer, even though the router is disconnected from the company network?
  5. Turn off all devices, router, and computer. First switch on the router and wait until it has successfully completed its self-test. Firstly, turn on the router and secondly turn on the devices and the computer.
    - Has this been successful?
  6. Replace the patch cable to the device with that no connection could be established.
    - Has this been successful?
  7. Make sure that the IP port of the device matches the port in the chromatography software.

## 7.2 Error messages

If other error messages are displayed besides those listed below, please restart the device. Inform the Technical Support of the manufacturer in case the error message displays repeatedly.

Display	Software	Measure
EXTERNAL	External error	Check the external devices and cable connections.
CALIBR	Calibration failed	<ul style="list-style-type: none"> <li>■ Restart the device. Check whether lamps, motor and filter are functioning correctly. Inform the Customer Support in case the system message repeats itself.</li> <li>■ Restart calibration on the device or in the chromatography software.</li> </ul>
NO LAMP	D2 lamp operation failed	Restart the device. If the error occurs again, replace the lamp.
NO CALIB	Cannot operate an uncalibrated instrument	Restart the device. Wait until calibration is completed.
MOTOR	Motor failure	Restart the device. Inform the Customer Support in case the system message repeats itself.
WAVELEN	Wavelength stabilization failed	Restart the device. Inform the Customer Support in case the system message repeats itself.
BUF.FULL	Data buffer overflow	Restart the device. Inform the Customer Support in case the system message repeats itself.
ZERO POS	Calibration failed - Zero order position not found	Restart the device. Inform the Customer Support in case the system message repeats itself.



## 8. Maintenance and care

Maintenance of a HPLC instrument is critical to the success of analyses and the reproducibility of results. If you require a maintenance task which is not described here, contact your dealer or the Customer Support.

### 8.1 Maintenance tasks

#### **DANGER**

##### **Electric shock**

High voltages inside the detector pose a life threatening risk.

- Only authorized service technicians are allowed to remove the housing and to replace the lamp.

#### **WARNING**

##### **Eye injury**

Eye irritation by UV light. Bundled UV light can escape from the flow cell or fiber optic cables.

- Switch off the detector and disconnect it from the power supply.

#### **NOTICE**

##### **Electronic defect**

Performing maintenance tasks on a switched on device can cause damage to the device.

- Switch off the device.
- Pull the power plug.

Users may perform the following maintenance tasks themselves:

- Regularly check the light intensity of the D<sub>2</sub> lamp (best before 2000 operating hours).
- Inspect the flow cell assembly
- Clean the flow cell.
- Replace the flow cell.

### 8.2 Maintenance contract

The device may only be opened by the Technical Service of KNAUER or any company authorized by KNAUER. These maintenance tasks are part of a separate maintenance contract.

## 8.3 Replacing the flow cell

UV light will cause the flow cells to become blind with time (solarization), making them no longer suitable for use.

### Prerequisite

- Detector is switched off.
- Power plug is disconnected from the device.
- Capillaries are disconnected.

### Steps

1. Unscrew the knurled-headscrews ①.
2. Pull out the slide ②.
3. Remove the flow cell.

### Figure

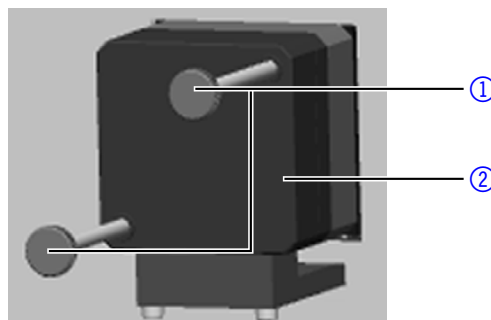

**Fig. 28** Removing the slide

4. Insert the flow cell ④ into the slide.
5. Push the slide ③ into the detector.
6. Insert the knurled-head screws and screw tight.

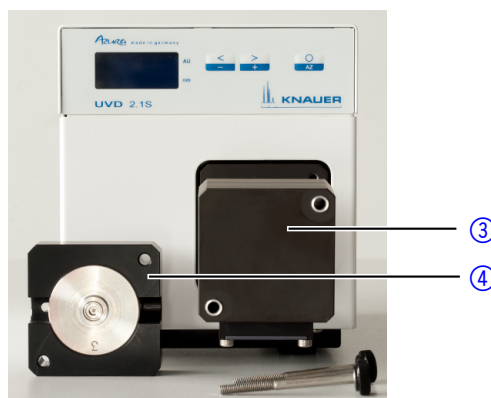

**Fig. 29** Assembling the flow cell

**Result** The flow cell is assembled.

**Next step** Connect the capillaries.

## 8.4 Cleaning and caring for the device

### NOTICE

#### Device defect

Intruding liquids can cause damage to the device.

- Place solvent bottles next to the device or in a solvent tray.
- Moisten the cleaning cloth only slightly.

All smooth surfaces of the device can be cleaned with a mild, commercially available cleaning solution, or with isopropanol.

## 8.5 Rinsing the flow cell

Increased baseline noise and reduced sensitivity can be a result of a dirty flow cell. Often it is sufficient to rinse the flow cell to restore optimal sensitivity.



**Note:** Dirty lenses or fiber optic connectors could falsify the measurement. Do not touch the lens or the fiber optic connector lenses with bare hands. Wear gloves.

### NOTICE

#### Performance decrease

For the drying step, oil drops from compressed air can contaminate the flow cell which may result in performance decrease.

→ Do not use compressed air for drying.

#### Prerequisite

- Flow cell is removed from the detector.
- Waste tube is connected to the flow cell.

#### Solvents

The following solvents are recommended for rinsing:

- Diluted HCl (1 mol/L)
- 1 ml/L NaOH aq.
- Ethanol
- Acetone

#### Tools

Syringe

#### Procedure

##### Process

1. Fill the syringe with eluent.
2. Inject it into the inlet of the flow cell and allow it to act for 5 minutes.
3. Fill the syringe with water and inject again.
4. Use a nitrogen stream to dry the flow cell.

#### Result

The flow cell is rinsed.

#### Next steps

- Check if the baseline noise has improved.
- If the rinsing does not have the desired effect, disassemble the flow cell to clean the lens.

## 8.5.1 Cleaning the lens of an analytical flow cell

**Prerequisite** Flow cell is removed from the detector.

- Tools**
- Tweezers
  - Allen screwdriver, size 3

### Legend

- ① Threaded ring
- ② Compression part
- ③ Lens
- ④ Seal ring

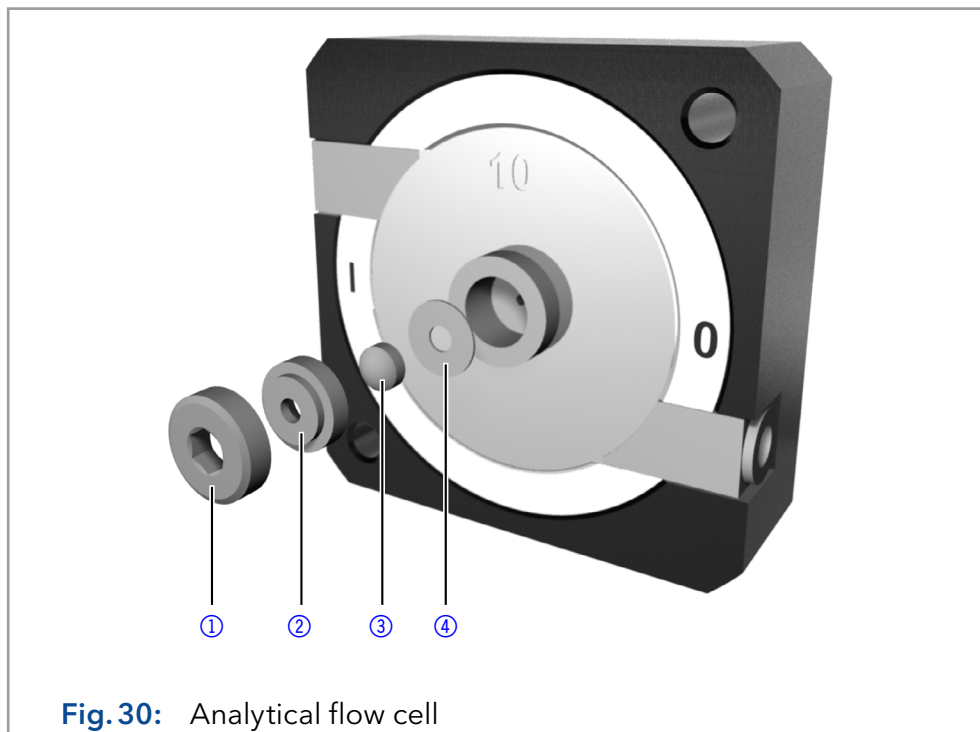

**Fig. 30:** Analytical flow cell

### Procedure

#### Process

1. Using the allen screwdriver, loosen the threaded ring ①.
2. Using tweezers or by gently tapping on a clean surface, remove the compression part ②.
3. The lens ③ is protected by a seal ring ④. This must be renewed every time the lens is disassembled.
4. Remove the lens and clean with a clean, soft cloth or with water in an ultrasonic bath.
5. Assemble the flow cell. Make sure that the new seal ring does not interrupt the light path.
6. Using the allen screwdriver, tighten the threaded ring ① to a torque of 1 Nm.

**Result** The flow cell lens is clean.



**Note:** If the cleaning of the lens does not have the desired effect, the lens has to be replaced.

**Next steps** Mount the flow cell onto the detector.

## 8.5.2 Cleaning the light guide of a preparative flow cell

The preparative flow cells have a rod shaped light guide instead of the concave lens of the analytical cells.

**Prerequisite** Flow cell is removed from the detector.

**Tools**

- Tweezers
- Allen screwdriver, size 3

### Legend

- ① Threaded ring
- ② Cover
- ③ Spacer
- ④ Compression bushing
- ⑤ Light guide with seal ring

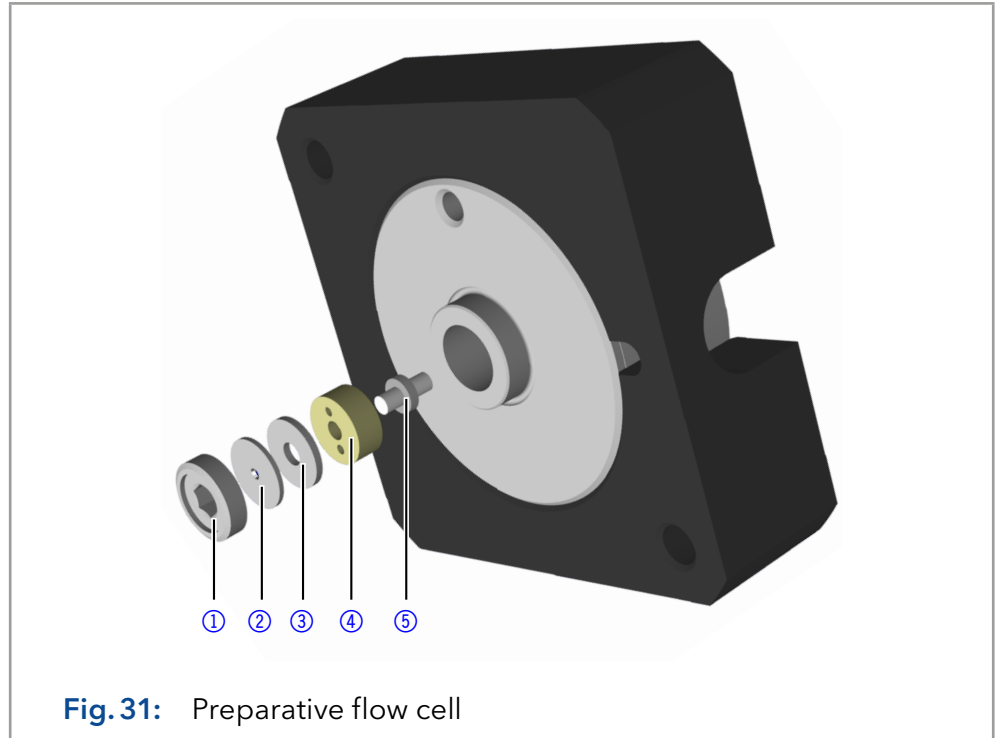

**Fig. 31:** Preparative flow cell

### Procedure

#### Process

1. Using the allen screwdriver, loosen the threaded ring ①.
2. Remove the cover ② and the spacer ③ (not part of all flow cells).
3. Using tweezers, pull out the compression bushing ④ and the light-guide ⑤.
4. Carefully push the light guide out of the holder and strip off the seal. The seal ring needs to be renewed during every cleaning of the fiber optics.
5. Clean the light guide with a clean, soft cloth or with an appropriate solvent in an ultrasonic bath. Make sure that the clean light guide is not touched by fingers.
6. Assemble the flow cell. Make sure that the new seal ring does not interrupt the light path.
7. Using the allen screwdriver, tighten the threaded ring ①.

**Result** The flow cell lens is clean.



**Note:** If the cleaning of the lens does not have the desired effect, the lens has to be replaced.

**Next steps** Mount the flow cell onto the detector.

## 8.6 Replacing the fiber optics

UV light will cause the fiber optics to become blind with time (solarization), making them no longer suitable for use.



**Note:** Observe the following regarding the use of fiber optics:

- Do not touch the ends of the fiber optics with your fingers, as this could falsify the measurement.
- Handle the fiber optics with care and avoid impacts.
- Move the fiber optics carefully without using pressure or bending it.

**Prerequisite** Detector is switched off.

**Tools** Cap fittings for fiber optics

### Steps

### Figure

1. To detach from the flow cell, unscrew the fittings ① of the fiber optics manually.

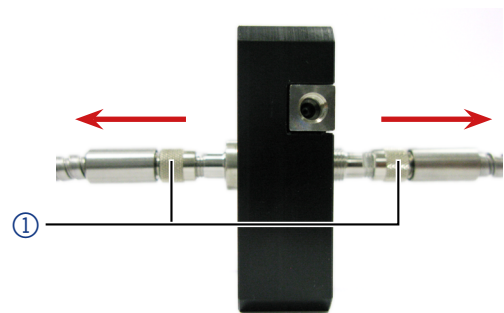

**Fig.32** Fiber optics fittings on flow cell

2. Seal the fiber optic connectors with caps ②.

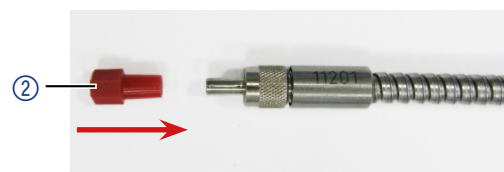

**Fig.33** Cap for optic connector

3. Manually, unscrew the fiber optics from the detector.
4. To mount new fiber optics ③ onto the flow cell, repeat the steps 1-3 in reverse order.

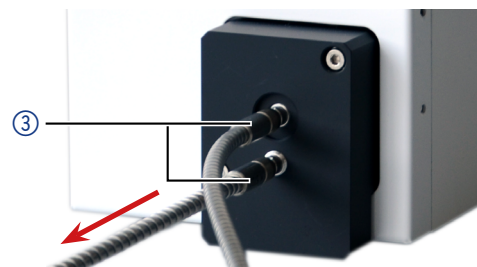

**Fig.34** Fiber optics on the detector

**Result** The fiber optics are replaced.

## 9. Transport and storage

Regarding the following information, carefully prepare the device for transport or storage.

### 9.1 Taking the device out of operation

**Prerequisites** The device is switched off.

#### Procedure

#### Process

1. Pull the power plug out of the socket and then out of the device.
2. Pack the power cable together with the device.

**Next steps** Disconnect all electrical connections. Remove the accessories and pack the device for transport or storage.

### 9.2 Packing the device

- Original packaging: Ideally you should use the original transport packaging.
- Lifting: Grab the device around the center of both sides and lift it into the packaging. Do not hold onto front cover or leak tray, as these parts are loosely attached to the device.

### 9.3 Transporting the device

- Documents: If you want to return your device to KNAUER for repairs, enclose the "[Service request form and decontamination report](#)" which can be downloaded from our website.
- Device data: For a secure transport, note the weight and dimensions of the device (see chapter 11 on page 44).

### 9.4 Storing the device

- Flushing solution: Pay attention that all hoses and capillaries have been emptied or filled with flushing solution (e. g. isopropanol) before storage. To prevent algae formation, do not use pure water.
- Seals: Close all inputs and outputs with cap fittings.
- Ambient conditions: The device can be stored under ambient conditions which are listed in the Technical Data section (see chapter 11 on page 44).

## 10. Disposal

Hand in old devices or disassembled old components at a certified waste facility, where they will be disposed of properly.

### 10.1 AVV-Marking Germany

According to the German "Abfallverzeichnisverordnung" (AVV) (January, 2001), old devices manufactured by KNAUER are marked as waste electrical and electronic equipment: 160214.

### 10.2 WEEE registration number

KNAUER as a company is registered by the WEEE number DE 34642789 in the German "Elektroaltgeräteregister" (EAR). The number classifies to category 8 and 9, which, among others, comprises laboratory equipment.

All distributors and importers are responsible for the disposal of old devices, as defined by the WEEE directive. End-users can send their old devices manufactured by KNAUER back to the distributor, the importer, or the company free of charge, but would be charged for the disposal.

### 10.3 Eluents and other operating materials

All eluents and other operating materials must be collected separately and disposed of properly.

All wetter components of a device, e. g. flow cells of detectors or pump heads and pressure sensors for pumps, have to be flushed with isopropanol first and water afterwards before being maintained, disassembled or disposed.



# 11. Technical data

## 11.1 Detection

Detector type	<ul style="list-style-type: none"> <li>■ Small variable single wavelength UV/VIS detector</li> <li>■ Small variable single wavelength UV/VIS detector with fiber optic connectors</li> </ul>
Detection channels	1
Light source	Deuterium (D <sub>2</sub> ) lamp with integrated GLP chip
Wavelength range	190-500 nm
Spectral bandwidth	13 nm at H <sub>α</sub> line (FWHM)
Wavelength accuracy	± 3 nm
Wavelength precision	0.7 nm (ASTM E275-93)
Noise	<ul style="list-style-type: none"> <li>■ ± 2.0 × 10<sup>-5</sup> AU at 254 nm (ASTM E1657-98)</li> <li>■ Fiber optics version: ± 2.5 × 10<sup>-5</sup> AU at 254 nm (ASTM E1657-98)</li> </ul>
Drift	<ul style="list-style-type: none"> <li>■ 3.0 × 10<sup>-4</sup> AU/h at 254 nm (ASTM E1657-98)</li> <li>■ Fiber optics version: 4.0 × 10<sup>-4</sup> AU/h at 254 nm (ASTM E1657-98)</li> </ul>
Linearity	> 2.0 AU at 270 nm (ASTM E1657-98)
Time constraints	0.0 / 0.02 / 0.05 / 0.1 / 0.2 / 0.5 / 1.0 / 2.0 s
Integration time	Automatic

## 11.2 Communication

Max. data rate	50 Hz (LAN), 20 Hz (analog), 10 Hz (RS-232)
Interfaces	<ul style="list-style-type: none"> <li>■ LAN (RJ-45)</li> <li>■ RS-232 (SUB-D 9, service only)</li> <li>■ Pin header</li> <li>■ Analog (RCA cinch connector)</li> </ul>
Control	<ul style="list-style-type: none"> <li>■ Manually via front panel</li> <li>■ Mobile Control</li> <li>■ Chromatography software</li> <li>■ Event control</li> <li>■ Analog: wavelength control</li> <li>■ Terminal protocol</li> </ul>
Inputs	<ul style="list-style-type: none"> <li>■ Error (either IN or OUT)</li> <li>■ Start (IN)</li> <li>■ Autozero</li> <li>■ 0-10 V Analog IN</li> </ul>
Output	Error (either IN or OUT)
Analog output	1 x ± 2.5 V scalable, 20 bit

## 11.3 General

Dimensions	121 × 129 × 187 mm
(W × H × D)	121 × 129 × 236 mm (with flow cell)
Weight	1.5 kg
GLP	Lamp operating hours
Display	LED
Power supply	External: Input 100–240 V, output 24 V DC, 60 W
Max. power input	100 W
Temperature range	4–40 °C, 39.2–104 °F
Air humidity	Below 90 %, non-condensing
Protection type	IP 20
Max. operating height	Maximum 2 000 meters above sea level

## 12. Reorders

The list of repeat orders is current at the time of publication. Deviations at a later time are possible. Use the enclosed packing list for reordering spare parts. If you have any questions regarding spare parts or accessories, please contact our Customer Support.

### Further information

Current information on spare parts and accessories can be found on the Internet at [www.knauer.net](http://www.knauer.net).

### 12.1 Devices

Name	Order no.
AZURA® UV Detector UVD 2.1S without flow cell	ADA00
AZURA® UV Detector UVD 2.1S Fiber Optics Version without flow cell	ADA05

### 12.2 Software

Name	Order no.
Mobile Control license display	A9610
Mobile Control Chrom license data	A9612
Mobile Control license display incl. tablet	A9607
Mobile Control Chrom license data incl. tablet	A9608

### 12.3 Accessories and spare parts

Name	Order no.
Tool kit AZURA®	A1033
Spare part kit for analytical flow cells	A1131

Name	Order no.
Spare part kit for preparative flow cells	A1132
Accessories kit	FDA
AZURA® accessories kit	FZA01
Deuterium lamp	A5193

## 12.4 Fiber optic connectors

Name	Order no.
2 × fiber optic connector 750 mm	A0740
2 × fiber optic connector 750 mm, high temperature up to 85°C	A0740HT
2 × fiber optic connector, custom made size	A0743

## 12.5 Flow cells

Most flow cells are also available equipped with fiber optic connectors for the use with the fiber optics version of the detector.

### 12.5.1 Analytical flow cells

Technical data		Order No.
Path length	10 mm	A4061XB
Connection	1/16"	Fiber optics version:
Inner diameter	1.1 mm	A4074
Volume	10 µl	
Material	Stainless steel with heat exchanger	
Max. flow rate	20 ml/min	
Max. pressure	300 bar	
Path length	3 mm	A4042
Connection	1/16"	Fiber optics version:
Inner diameter	1.0 mm	A4044
Volume	2 µl	High temperature
Material	Stainless steel	version: A4044HT
Max. flow rate	50 ml/min	
Max. pressure	300 bar	
Max. temperature	85°C (A4044HT only)	
Path length	3 mm	A4045
Connection	1/16"	Fiber optics version:
Inner diameter	1.0 mm	A4047
Volume	2 µl	
Material	PEEK	
Max. flow rate	50 ml/min	
Max. pressure	30 bar	

## 12.5.2 Preparative flow cells

Technical data		Order No.
Path length	0.5 / 1.25 / 2 mm	A4066
Connection	1/8"	Fiber optics version: A4078
Inner diameter	2.3 mm	
Volume	1.7 / 4.3 / 6.8 $\mu$ l	
Material	Stainless steel	
Max. flow rate	1 000 ml/min	
Max. pressure	200 bar	
Path length	0.5 / 1.25 / 2 mm	A4067
Connection	1/8"	Fiber optics version: A4079
Inner diameter	2.3 mm	
Volume	1.7 / 4.3 / 6.8 $\mu$ l	
Material	PEEK	
Max. flow rate	1 000 ml/min	
Max. pressure	100 bar	
Path length	0.5 / 1.25 / 2 mm	A4068 (angular connections)
Connection	1/4"	A4068-2 (straight connections)
Inner diameter	4.0 mm	Fiber optics version: A4081 (angular connections)
Volume	1.7 / 4.3 / 6.8 $\mu$ l	A4081V2 (straight connections)
Material	Stainless steel	
Max. flow rate	10 000 ml/min	
Max. pressure	200 bar	
Path length	0.5 mm	A4069
Connection	1/16"	Fiber optics version: A4089
Inner diameter	0.8 mm	
Volume	3 $\mu$ l	
Material	Stainless steel	
Max. flow rate	250 ml/min	
Max. pressure	200 bar	
Path length	0.5 mm	A4095
Connection	1/16"	Fiber optics version: A4096
Inner diameter	0.8 mm	
Volume	3 $\mu$ l	
Material	PEEK	
Max. flow rate	250 ml/min	
Max. pressure	100 bar	

### 12.5.3 Preparative flow cells - fiber optics

Technical data		Order No.
Path length	10 mm	A4154-1
Capillary connection	3/8" with Tri-Clamp	
Material	PEEK	
Max. flow rate	10 000 ml/min	
Max. pressure	10 bar	
Path length	7 mm	A4152-1
Capillary connection	3/8" with Tri-Clamp	
Material	PEEK	
Max. flow rate	10 000 ml/min	
Max. pressure	10 bar	
Path length	0.5 / 1.25 / 2 mm	A4154
Capillary connection	1/2" with Tri-Clamp	
Material	Stainless steel	
Max. flow rate	10 000 ml/min	
Max. pressure	80 bar	
Path length	0.5 / 1.25 / 2 mm	A4155
Capillary connection	3/4" with Tri-Clamp	
Material	Stainless steel	
Max. flow rate	10 000 ml/min	
Max. pressure	80 bar	
Path length	0.5 / 1.25 / 2 mm	A4152
Capillary connection	3/8" with Tri-Clamp	
Material	Stainless steel	
Max. flow rate	10 000 ml/min	
Max. pressure	80 bar	
Path length	0.5 / 1.25 / 2 mm	A4153
Capillary connection	1/4" with Tri-Clamp	
Material	Stainless steel	
Max. flow rate	10 000 ml/min	
Max. pressure	80 bar	

### 12.5.4 Test cells

Technical data		Order No.
Test cell	Normal	<ul style="list-style-type: none"> <li>■ A4123</li> <li>■ Fiber optics version: A4125</li> </ul>
Test cell	Holmium oxide filter	<ul style="list-style-type: none"> <li>■ A4126</li> <li>■ Fiber optics version: A4128</li> </ul>
Test cell	Stray light filter	<ul style="list-style-type: none"> <li>■ A4146</li> <li>■ Fiber optics version: A4148</li> </ul>

## 13. Chemical compatibility of wetted materials



**Note:** The user takes the responsibility for using the fluids and chemicals in an appropriate and safe way. If there is any doubt, contact the Technical Support of the manufacturer.

### 13.1 General

The device is very resistant against a variety of commonly used eluents. However, make sure that no eluents or water come in contact with the device or enter into the device. Some organic solvents (such as chlorinated hydrocarbons, ether) may cause coating damage or loosen glued components by improper handling. Even small quantities of other substances, such as additives, modifiers, or salts can influence the durability of the materials. Exposure time and concentration have a high impact on the resistance.

The following list contains information about the chemical compatibility of all wetted materials which are used in devices made by KNAUER. The data bases on a literature research on the manufacturer specifications of the materials. The wetted materials of this device are listed in the chapter "Technical data".

All resistances mentioned here are for use at temperatures up to 40 °C, unless stated otherwise. Please note that higher temperatures can significantly affect the stability of different materials.

### 13.2 Plastics

#### Polyetheretherketone (PEEK)

PEEK is a durable and resistant plastic and, next to stainless steel, the standard material in HPLC. It can be used at temperatures up to 100 °C and is highly chemical resistant against almost all commonly used solvents in a pH range of 1-12,5. PEEK is potentially moderate resistant against oxidizing and reducing solvents.

Therefore, following solvents should not be used: Concentrated and oxidizing acids (such as nitric acid solution, sulfuric acid), halogenated acids (such as hydrofluoric acid, hydrobromic acid) and gaseous halogens. Hydrochloric acid is approved for most applications.

In addition, following solvents can have a swelling effect and may have an impact on the functionality of the built-in components: Methylene chloride, THF and DMSO in any concentration such as acetonitrile in higher concentrations.

#### Polyethylene terephthalate (PET, outdated PETP)

PET is a thermoplastic and semi-crystalline material with high wear resistance. It is resistant against diluted acids, aliphatic and aromatic hydrocarbons, oils, fats and alcohols, but not against halogenated hydrocarbons and ketones. Since PET belongs chemically to esters, it is not compatible with inorganic acids, hot water and alkalis. Maximum operating Temperature: up to 120 °C.

**Polyimide (Vespel®)**

This material is wear-resistant and permanent resilient thermally (up to 200 °C) as well as mechanically. It is chemically broadly inert (pH range 1-10) and is especially resistant against acidic to neutral and organic solvents, but vulnerable to pH strong chemical or oxidizing environments: It is incompatible with concentrated mineral acids (such as sulfuric acid), glacial acetic acid, DMSO and THF. In addition, it will be disintegrated by nucleophilic substances like ammonia (such as ammonium salts under alkaline conditions) or acetate.

**Ethylene-tetrafluorethylene copolymer (ETFC, Tefzel®)**

This fluorinated polymer is highly resistant against neutral and alkaline solvents. Some chlorinated chemicals in connection with this material should be handled with care. Maximum operating Temperature is 80 °C.

**Perfluorethylenpropylen-Copolymer (FEP), Perfluoralkoxy-Polymer (PFA)**

These fluorinated polymers hold similar features as PTFE, but with a lower operation temperature (up to 205 °C). PFA is suitable for ultrapure applications, FEP can be used universally. They are resistant against almost all organic and inorganic chemicals, except elemental fluorine under pressure or at high temperatures and fluorine-halogen compounds.

**Polyoxymethylene (POM, POM-H-TF)**

POM is a semi-crystalline, high-molecular thermoplastic material which stands out due to its high stiffness, low friction value and thermic stability. It can even substitute metal in many cases. POM-H-TF is a combination of PTFE fibres and acetal resin and is softer and has better slip properties as POM. The material is resistant against diluted acids (pH > 4) as well as diluted lyes, aliphatic, aromatic and halogenated hydrocarbons, oils and alcohols. It is not compatible with concentrated acids, hydrofluoric acid and oxidizing agent. Maximum operating Temperature is 100 °C.

**Polyphenylene sulfide (PPS)**

PPS is a soft polymer which is known for its high break resistance and very high chemical compatibility. It can be used with most organic, pH neutral to pH high, and aqueous solvents at room temperature without concerns. However, it is not recommended for using with chlorinated, oxidizing and reducing solvents, inorganic acids or at higher temperatures. Maximum operating temperature: 50 °C

**Polytetrafluorethylene (PTFE, Teflon®)**

PTFE is very soft and anti-adhesive. This material is resistant against almost all acids, lyes and solvents, except against fluid sodium and fluoride compounds. In addition, it is temperature-resistant from -200 °C to +260 °C.

**Systec AF™**

This amorphous perfluorinated copolymer is inert against all commonly used solvents. However, it is soluble in perfluorinated solvents like Fluorinert® FC-75 and FC-40, and Fomblin perfluor-polyether solvents from Ausimont. In addition, it is affected by Freon® solvents.

**Polychlorotrifluoroethylene (PCTFE, Kel-F®)**

The semi-crystalline thermoplastic material is plasticizer-free and dimensionally stable, even in a wide temperature range (−240 °C to +205 °C). It is moderately resistant against ether, halogenated solvents and toluene. Halogenated solvents over +60 °C and chlorine gas should not be used.

**Fluorinated rubber (FKM)**

The elastomer consisting of fluorinated hydrocarbon stands out due to a high resistance against mineral oils, synthetic hydraulic fluids, fuels, aromatics, and many organic solvents and chemicals. However, it is not compatible with strong alkaline solvents (pH value >13) like ammonia, and acidic solvents (pH value <1), pyrrole and THF. Operating temperature: Between −40 °C and +200 °C.

**Perfluorinated rubber (FFKM)**

This perfluoro elastomer has a higher fluorine content as fluorinated rubber and is therefore chemically more resistant. It can be employed at higher temperatures (up to 275 °C). It is not compatible with Pyrrole.

## 13.3 Non-metals

**Diamond-like carbon (DLC)**

This material is characterized by a high hardness, a low coefficient of friction and thus low wear. In addition, it is highly biocompatible. DLC is inert against all acids, alkalis and solvents commonly used in HPLC.

**Ceramic**

Ceramic is resistant against corrosion and wear and is fully biocompatible. An incompatibility against acids, alkalis and solvents commonly used in HPLC is not known.

**Alumina (Al<sub>2</sub>O<sub>3</sub>)**

Due to their high resistance to wear and corrosion, alumina ceramic is used as a coating for mechanically stressed surfaces. It is a biocompatible material with low thermal conductivity and low thermal expansion.

**Zirconium oxide (ZrO<sub>2</sub>)**

Zirconia ceramics are characterized by their high mechanical resistance, which makes them particularly resistant to wear and corrosion. It is also biocompatible, has low thermal conductivity and is resistant to high pressures.

**Sapphire**

Synthetic sapphire is virtually pure monocrystalline alumina. It is biocompatible and very resistant to corrosion and wear. The material is characterized by a high hardness and a high thermal conductivity.

**Ruby**

Synthetic ruby is monocrystalline alumina and gets its red color by the addition of some chromium oxide. It is biocompatible and very resistant to corrosion and wear. The material is characterized by a high hardness and a high thermal conductivity.



**Mineral wool**

This insulating material consists of glass or stone wool fibres and isolates in high oxidizing conditions and at high temperatures. Mineral wool is valid as commonly inert against organic solvents and acids.

**Glass, glass fibre, quartz, quartz glass**

These mineral materials are resistant against corrosion and wear and are mostly chemical inert. They are compatible with oils, fats and solvents and show a high resistance against acids and lyes up to pH values of 3-9. Concentrated acids (especially hydrofluoric acid) may embrittle and corrode the minerals. Lyes may ablate the surfaces slowly.

## 13.4 Metals

**Stainless steel**

Stainless steel is, apart from PEEK, the standard material in HPLC. Steels with WNr. 1.4404 (316L) are used, or with a mixture of higher compatibility.

They are inert against almost all solvents. Exceptions are biological applications which are metal ion sensitive, and applications with extreme corrosive conditions. These steels, in comparison to commonly used steels, are increasingly resistant against hydrochloric acid, cyanides and other halogen acids, chlorides and chlorinated solvents.

The use in ion chromatography is not recommended. In case of electrochemical applications, a passivation must be executed first.

**Hastelloy®-C**

This nickel-chrome-molybdenum alloy is extremely resistant to corrosion, especially against oxidizing, reducing and mixed solvents, even at high temperatures. This alloy may be used in combination with chlor, formic acid, acetic acid and saline solutions.

**Titanium, titanium alloy (TiA16V4)**

Titanium has a low weight and a high hardness and stability. It stands out due to its very high chemical compatibility and biocompatibility. Titan is applied when neither stainless steel nor PEEK are usable.

# 14. Index

## A

Ambient conditions 9, 41  
  Air humidity 44  
Analog control 23  
Analog output 43  
Analytical flow cell 38  
AVV-marking 42

## C

Capillaries  
  connecting 13  
Chemical compatibility 48  
Chromatography software 25  
Cleaning  
  device 36  
  flow cell 37  
Communication 43  
Company network 17  
Connector assignment 22  
Control 43

## D

Data rate 43  
Decontamination Report 41  
Detection channels 43  
Detector type 43  
Dimensions 44  
Disposal 42  
Drift 43

## F

Fiber optics  
  replacing 40  
Firmware Wizard:  
  Setting IP addresses 20-21  
Flow cell  
  cleaning 37  
  inserting 11  
  replacing 36  
Flushing solution 41

## G

GLP 44

## I

Initial startup 9  
Inputs 43  
Installation 9  
Installation Qualification (IQ) 32  
Integration time 43  
Interfaces 43  
IP address  
  setting 18-21

## L

Lamp 35  
LAN  
  connect 15-17  
  Troubleshooting 33  
Light source 43  
Linearity 43

## M

Maintenance 35  
  contract 35  
  tasks 35  
Mobile Control 25  
  Setting IP addresses 18-20

## N

Noise 43

## O

Old devices 42  
Operation 25  
Operation Qualification (OQ) 32  
Operation site 9  
Optical path length  
  setting 12  
Original packaging 41  
Outputs 43

## P

Pin header 22  
Power input 44  
Power supply , 10  
Preparative flow cell 39  
  setting optical path length 12

## R

Remote control 22  
Reorders 44  
Router 16

## S

Service request form 41  
Software control 25  
Solvent  
  Disposal 42  
Space requirement 10  
Spectral bandwidth 43  
Storage 41

**T**

Taking out of operation 41

Technical data 43

Temperature 44

  ambient 9

Time constraints 43

Transport 41

**U**

Unpacking 9

**W**

Wavelength accuracy 43

Wavelength precision 43

Wavelength range 43

WEEE Registration Number 42

Weight , 41

### Installation Qualification (IQ) for a Device

	Created	Reviewed	Approved
Function			
Name			
Date			
Signature			

#### 0. Customer approval

Prior to installation at the customer site, the customer has reviewed the OQ document and agrees with the design and scope.

Company name:

Name	Function	Reviewed & approved	Date	Signature

## Installation Qualification (IQ) for a Device

### 1. Definition of the Installation Qualification

The qualification document „Installation Qualification (IQ)“ is part of the quality management system at the company KNAUER Wissenschaftliche Geräte GmbH.

### 2. Scope

The customer can request the Installation Qualification. In case of a request, the technical support of KNAUER or a provider authorized by KNAUER performs this functionality test during the installation. The IQ is a standardized document and includes the following:

- Confirmation of flawless condition at delivery
- Check if the delivery is complete
- Certification on the functionality of the device

### 3. Instructions

All deviations from the specifications that occurred during installation have to be recorded in this document.

In addition, all measures taken to eliminate the deviations have to be noted down as comments in the list of rectifications (LOR) on page 4.

If certain items in the report are not applicable, this has to be indicated in the table as „N/A“ (not applicable). Major sections that are not used have to be crossed out (diagonal line), marked „N/A“, dated and signed.

All required documents have to be completed by the end of the installation. The document has to be reviewed and approved by an authorized person. The review and approval have to be documented with signature and date (DD/MM/YYYY).

The tests have to be carried out in a suitable environment, as described in the user instruction of the device.

### 4. About this document

The information in this document is subject to change without prior notice. This document may not be used, reproduced or translated without written consent of KNAUER Wissenschaftliche Geräte GmbH. Depending on the customer's quality assurance system, the signed document either has to be filed in the device folder or scanned and stored in an electronic archive.

### 5. Device data

Device name		Product number	
Serial number		Order number	
Firmware version			
Installation location			

### 6. Customer and manufacturer data

	Customer	Manufacturer
Company		KNAUER Wissenschaftliche Geräte GmbH
Customer number		-
Contact person/agent		
Address		Hegauer Weg 38
Postal code/City		14163 Berlin
Phone		+49 30 80 97 27 111
E-Mail		support@knauer.net

## Installation Qualification (IQ) for a Device

### 7. Installation Qualification Tests

Test	Description	Specification	Passed	Failed	N/A	Comment/LOR no.
1	Identify the device.	The name on the device matches the name on the delivery order.				
2	Check the device for transport damage.	No transport damage is observed.				
3	Check the scope of delivery.	The scope of delivery matches the packing list and/or the delivery order.				
4	Check that the technical documentation provided is correct and complete (material documentation of wetted parts, calibration certificates etc.)	The documentation is correct and complete.				
5	Check that all equipment is properly and correctly labeled according to the delivery order and/or the labeling specifications document, if applicable.	The equipment is labeled correctly.				
6	Connect all loose parts (e.g. capillaries, tubings, measuring head) according to the user instructions.	The device is fully assembled and ready to use.				
7	Ensure that the installation site is suitable according to the user instructions.	The installation site matches the specifications in the user instructions.				
8	Connect the device to the power supply and switch it on.	The device starts (operating noise). The power LED or the display lights up.				

## Installation Qualification (IQ) for a Device

### 8. List of rectifications (LOR)

LOR no.	Test no.	Type of deviation*	Description of the deviation	Action plan	Persons responsible	Due date	Date/signature

\*Type of deviation:

A = acceptable (e.g. not a GMP-critical deviation)

N = not acceptable

Continuation of qualification activities into the next qualification phase is only possible when deviation is rectified.

T = temporarily acceptable

a) Release and use of the system is possible, even when the deviation is not rectified.

b) A continuation of qualification activities into the next qualification phase is possible, even when the deviation is not rectified

## Installation Qualification (IQ) for a Device

### 9. List of changes to the document

Revision no.	Description of change	Additional information	Date/signature



## Installation Qualification (IQ) for a Device

### 10. Certificate and approval

A KNAUER employee or an employee authorized by KNAUER has checked the device and performed all tests described in the IQ.

The IQ form has to be signed by an authorized person. The scope of the IQ meets the customer's requirements.

The results of the IQ, any changes made as well as the IQ process have been documented in this form in writing. The users listed below were instructed and are familiar with how to operate the device. Both parties confirm that the IQ has been performed to the customer's satisfaction by signing it.

#### 10.1 Customer approval

Name	Function	Date	Signature

#### 10.2 KNAUER agent approval

Name	Function	Date	Signature

### 11. Comments / recommendations

---



---



---

### Installation Qualification (IQ) for a Device

#### Appendix: List of supporting documents

No.	Test no.	Description

Science with Passion



Latest KNAUER instructions online:  
[www.knauer.net/library](http://www.knauer.net/library)

**KNAUER**  
Wissenschaftliche Geräte GmbH  
Hegauer Weg 38  
14163 Berlin

Phone: +49 30 809727-0  
Fax: +49 30 8015010  
E-mail: [info@knauer.net](mailto:info@knauer.net)  
Internet: [www.knauer.net](http://www.knauer.net)