

*Azura*

# Detector DAD 6.1L/DAD 2.1L/MWD 2.1L Instructions



Document nr. V6700

# HPLC



**Note:** For your own safety, read the instructions and follow the warnings and safety information on the device and in the instructions.  
Keep the instructions for future reference.



**Note:** In case you require this instruction in another language, please submit your request including the corresponding document number via e-mail or fax to KNAUER.

**Support:** Do you have questions about the installation or the operation of your instrument or software?

**International Support:**

Contact your local KNAUER partner for support:

[www.knauer.net/en/Support/Distributors-worldwide](http://www.knauer.net/en/Support/Distributors-worldwide)

**Support in Germany**

(Austria & Switzerland on case-to-case basis):

Phone: +49 30 809727-111 (workdays 9-17h CET)

Fax: +49 30 8015010

E-mail: [support@knauer.net](mailto:support@knauer.net)

**Publisher:** KNAUER Wissenschaftliche Geräte GmbH

Hegauer Weg 38

14163 Berlin

Germany

Phone: +49 30 809727-0

Fax: +49 30 8015010

Internet: [www.knauer.net](http://www.knauer.net)

E-mail: [info@knauer.net](mailto:info@knauer.net)

**Version information:** Document number: V6700

Version number: 4.10

Release date: August 28, 2023

Translation of the original edition

This instruction applies to products with the product number:  
ADC11 (DAD 6.1L), ADC01 (DAD 2.1L), ADB01 (MWD 2.1L)

The information in this document is subject to change without prior notice. For the latest version of the instructions, visit our website: [www.knauer.net/library](http://www.knauer.net/library).



**Copyright:** This document contains confidential information and may not be reproduced without written consent of KNAUER Wissenschaftliche Geräte GmbH.

© KNAUER Wissenschaftliche Geräte GmbH 2023

All rights reserved.

AZURA® is a registered trademark of  
KNAUER Wissenschaftliche Geräte GmbH.

# Table of contents

<b>1. General</b>	<b>1</b>
1.1 About these instructions	1
1.2 Signal words	1
1.3 Additional typographical conventions	1
1.4 Legal information	2
1.4.1 Liability limitation	2
1.4.2 Transport damage	2
1.4.3 Warranty conditions	2
1.4.4 Warranty seal	2
1.4.5 Declaration of conformity	2
<b>2. Basic safety instructions</b>	<b>3</b>
2.1 Intended use	3
2.1.1 Operating ranges	3
2.1.2 Foreseeable misuse	3
2.2 User qualification	3
2.3 Operator responsibility	4
2.4 Personal safety equipment	4
2.5 Safety features on the device	4
2.6 Working with solvents	5
2.6.1 General requirements	5
2.6.2 Contamination by health-threatening solvents	5
2.6.3 Avoiding leakage	5
2.7 Specific environments	6
2.7.1 Earthquake-endangered areas	6
2.7.2 Explosive environment	6
2.7.3 Cooling room	6
2.7.4 Wet room	6
2.8 Maintenance, care and repair	6
2.9 Service request form and decontamination report	7
<b>3. Product information</b>	<b>8</b>
3.1 Features	8
3.2 Scope of delivery	8
3.3 Views	8
3.4 Performance overview	9
3.5 Symbols and signs	11
<b>4. Installation and initial startup</b>	<b>13</b>
4.1 Unpacking	13
4.2 Ambient conditions	13
4.2.1 Operation site	13
4.2.2 Ambient temperature	13
4.2.3 Space requirements	14

---

4.3	Power supply	14
4.4	Connecting the leak management	15
4.5	Inserting the flow cell	16
4.5.1	Inserting the flow cell with fiber optics	17
4.6	Connecting the capillaries	18
4.7	Computer control	19
4.7.1	Setting up LAN	19
4.7.2	Configuring LAN settings	19
4.7.3	Connecting devices to the LAN	20
4.7.4	Configuring the router	20
4.7.5	Integrating LAN into the company network	21
4.7.6	Controlling several systems separately in LAN	21
4.8	Setting IP addresses via software	22
4.8.1	Mobile Control: Setting a static IP address	22
4.8.2	Mobile Control: Setting a dynamic IP address via device name	23
4.8.3	Mobile Control: Setting a dynamic IP address via device serial number	23
4.8.4	Firmware Wizard: Setting a static IP address	24
4.8.5	Firmware Wizard: Setting a dynamic IP address	25
4.8.6	Remote control	26
4.8.7	Connections to the terminal strip	27
4.8.8	Connecting the pin header	28
4.8.9	Integrator connector	29
4.9	Integrating the detector into the system	30
4.10	Pre-installed capillaries	30
<b>5.</b>	<b>Operation</b>	<b>31</b>
5.1	Initial startup	31
5.2	Switch on	31
5.3	Software operation	32
5.3.1	Control methods	32
5.3.2	Operating with Mobile Control	32
5.4	Meaning of the LEDs	32
5.5	Default settings	33
5.6	GLP	34
<b>6.</b>	<b>Optimizing the detector</b>	<b>36</b>
6.1	General	36
6.2	Selecting the flow cell	36
6.3	Selecting the wavelength	38
6.3.1	Bandwidth	39
6.4	Spectral range	40
6.5	Time constant & data rate	40
6.6	Integration time	41
6.7	Subtraction of the baseline chromatogram	42
6.7.1	Extended linear range	42

---

---

<b>7. Functionality tests</b> .....	<b>43</b>
7.1 Installation Qualification (IQ) .....	43
7.2 Operation Qualification (OQ) .....	43
<b>8. Troubleshooting</b> .....	<b>44</b>
8.1 LAN .....	44
8.2 Possible problems and solutions .....	45
8.3 System messages .....	46
<b>9. Maintenance and care</b> .....	<b>49</b>
9.1 General .....	49
9.1.1 Maintenance tasks performed by the user .....	49
9.1.2 Maintenance contract .....	50
9.1.3 Maintenance intervals .....	50
9.2 Cleaning and caring for the device .....	50
9.2.1 Handling the flow cell cartridge .....	50
9.2.2 Surfaces .....	51
9.3 Cleaning the flow cell .....	51
9.3.1 Basic cleaning .....	51
9.3.2 Advanced cleaning .....	52
9.3.3 Cleaning protocol for KNAUER LightGuide Flow cells .....	53
9.4 Replacing the flow cell .....	54
9.5 Replacing the lamps .....	55
9.5.1 Removing the deuterium or halogen lamp .....	56
9.5.2 Installing the deuterium or halogen lamp .....	57
9.6 Checking the fittings .....	58
9.7 Removing a leak .....	58
9.8 Decommissioning .....	59
<b>10. Transport and storage</b> .....	<b>60</b>
10.1 Packing the device .....	60
10.2 Transporting the device .....	60
10.3 Storing the device .....	60
<b>11. Disposal</b> .....	<b>61</b>
11.1 AVV-Marking Germany .....	61
11.2 WEEE registration number .....	61
11.3 Eluents and other operating materials .....	61
<b>12. Technical data</b> .....	<b>62</b>
12.1 DAD 6.1L .....	62
12.2 DAD 2.1L .....	63
12.3 MWD 2.1L .....	65
12.4 Conditions for specification .....	66

<b>13. Reorders</b> .....	<b>67</b>
13.1 Devices.....	67
13.2 Accessories and spare parts.....	67
13.3 Flow cells.....	68
13.4 Flow cells with fiber optics .....	69
13.5 Fiber optic cables.....	70
<b>14. Chemical compatibility of wetted materials</b> .....	<b>71</b>
14.1 General .....	71
14.2 Plastics.....	71
14.3 Non-metals .....	73
14.4 Metals.....	74
<b>15. Index</b> .....	<b>75</b>

# 1. General

## 1.1 About these instructions

These operating instructions enable the safe and efficient operation of the device. The user must have carefully read and understood these operating instructions before starting any work.





The basic prerequisite for safe operation is compliance with all safety instructions (see "2 Basic safety instructions", p. 3). In addition to the safety and warning instructions in these operating instructions, the local accident prevention regulations and the national industrial safety regulations apply.

These operating instructions are an integral part of the device. It has to be kept in the immediate vicinity of the device and accessible to the user at all times.

You can download these and other instructions from the KNAUER website: [www.knauer.net/library](http://www.knauer.net/library)

## 1.2 Signal words

Possible dangers related to the device are distinguished in personal and material damages.

Symbol	Meaning
	DANGER (red) indicates a highly hazardous situation. If not avoided, it will result in death or serious injury.
	WARNING (orange) indicates a hazardous situation. If not avoided, it could result in death or serious injury.
	CAUTION (yellow) indicates a moderate hazardous situation. If not avoided, it could result in minor or moderate injury.
	NOTICE (blue) is used to address issues which are not related to physical injury.

## 1.3 Additional typographical conventions

- General equal treatment: When persons are described, this document uses the male grammar form to keep the text easy to read. The form has a neutral sense and speaks to people of any gender in the same way.
- Note: Specific information are prefixed with the word "Note" and an information icon.

 | **Note:** This is an example.

## 1.4 Legal information

### 1.4.1 Liability limitation

The manufacturer is not liable for the following issues:

- Non-compliance of these instructions
- Non-observance of necessary safety precautions
- Improper use
- Operation of the device by unqualified personnel (see "2.2 User qualification", p. 3)
- Use of non-approved spare parts
- Technical changes by the user such as opening the device and unauthorized modifications
- Violations of General Terms and Conditions (GTC)

### 1.4.2 Transport damage

The packaging of our devices provides the best possible protection against transport damage. However, check the packaging for transport damage. In case you notice any damage, inform the Technical Support and the shipping company within three workdays.

### 1.4.3 Warranty conditions

For information on warranty please refer to our general terms and conditions on the website: [www.knauer.net/terms](http://www.knauer.net/terms)

### 1.4.4 Warranty seal

A blue or orange warranty seal is affixed to some devices.

- A blue seal is used by KNAUER's Manufacturing or Customer Support for devices to be sold.
- After repair, service technicians attach an orange seal onto the identical position.

If unauthorized persons tamper with the device or if the seal is damaged, the warranty will lapse.



### 1.4.5 Declaration of conformity

The declaration of conformity is enclosed as a separate document with the product and can be obtained online:

[www.knauer.net/en/Support/Declarations-of-conformity](http://www.knauer.net/en/Support/Declarations-of-conformity)



---

## 2. Basic safety instructions

The device has been developed and constructed in such a way that hazards arising from its intended use are largely excluded. Nevertheless, the following safety instructions have to be observed in order to exclude residual hazards.

### 2.1 Intended use

Only use the device for applications that fall within the range of the intended use. Otherwise, the protective and safety equipment of the device could fail.

#### 2.1.1 Operating ranges

The device is intended to be used indoors for chromatographic applications.

#### 2.1.2 Foreseeable misuse

Refrain from the use of the device for the following purposes or conditions:

- Medical purposes. The device is not approved as a medical product.
- Operating outdoors. Otherwise, the manufacturer does not guarantee the functionality and safety of the device.
- Operation in potentially explosive areas without special and additional explosion protection. Contact the KNAUER Customer Support for more information.

### 2.2 User qualification

The user is qualified to handle the device if all of the following points apply:

- He has at least a basic knowledge of liquid chromatography.
- He has knowledge about the properties of the used solvents and their health risks.
- He is trained for the special tasks and activities in the laboratory and knows the relevant standards and regulations.
- Due to his technical training and experience, he can understand and carry out all the work described in the operating instructions on the instrument and recognize and avoid possible dangers independently.
- His ability to react is not impaired by the consumption of drugs, alcohol or medication.
- Participation in the installation of a device or a training by the company KNAUER or an authorized company.

If the user does not meet these qualifications, he has to inform his supervisor.

## 2.3 Operator responsibility

The operator is any person who operates the device himself or leaves it to a third party for use and who bears the legal product responsibility for the protection of the user or third parties during operation.

The obligations of the operator are listed below:

- Know and follow the applicable work safety regulations
- Identify hazards arising from the working conditions at the place of use in a risk assessment.
- Set up operating instructions for the operation of the device.
- Regularly check whether the operating instructions correspond to the current status of the regulations.
- Clearly regulate and specify responsibilities for installation, operation, troubleshooting, maintenance and cleaning and set clear rules
- Ensure that all personnel who work with the device have read and understood these operating instructions
- Train the personnel who work with the device at regular intervals and inform them about the dangers.
- Provide the necessary safety equipment to the employees working with the unit (see section below).

## 2.4 Personal safety equipment

The protective measures required in the laboratory have to be observed and the following protective clothing worn during all work on the device:

- Safety glasses with side protection
- Protective gloves in accordance with the prevailing ambient conditions and used solvents (e.g. heat, cold, protection against chemicals)
- Lab coat
- Personalized protective safety equipment which is specified in the particular laboratory.

## 2.5 Safety features on the device

- Power switch: Devices of the AZURA® L series may be switched off using the power switch (toggle switch on the back side of housing) at any time, this causes no damage to the device. To switch off devices of the AZURA® S series, remove the plug from the power socket.
- Front cover: Devices of the AZURA® L series have a front cover as a splash protection for the user
- Leak tray: Devices of the AZURA® L series have a leak tray on the front side. The leak tray collects leaking solvents and protects components from potential damage caused by discharging liquid.
- Lamp: For the detectors AZURA DAD 2.1L, DAD 6.1L und MWD 2.1L, the lamp switches off automatically when the cover is opened.

## 2.6 Working with solvents

### 2.6.1 General requirements

- The user is trained for handling different solvents.
- Note recommended solvents and concentrations in these instructions in order to avoid personal injury or damage to the device. For example, certain chemicals may cause PEEK capillaries to swell or burst (see "14 Chemical compatibility of wetted materials", p. 71).
- Note that organic solvents are toxic above a certain concentration. For handling hazardous solvents see the following section.
- Mobile phases and samples may contain volatile or combustible solvents. Avoid the accumulation of these substances. Ensure good ventilation of the installation site. Avoid open flames and sparks. Do not operate the instrument in the presence of flammable gases or vapors.
- Only use solvents which do not self-ignite under given conditions. This applies especially to the use of a thermostat where liquids could get onto hot surfaces in the interior.

### 2.6.2 Contamination by health-threatening solvents

- Contamination with toxic, infectious or radioactive substances poses a hazard for all persons involved during operation, repair, sale, and disposal of a device.
- All contaminated devices have to be decontaminated properly by a specialist company or the operating company before they can be re-commissioned, repaired, sold, or disposed (see "11 Disposal", p. 61).

### 2.6.3 Avoiding leakage

Risk of electrical shock or short circuit if solvents or other liquids leak into the interior of the device. You can avoid a leakage through the following measures:

- Tightness: Visually check the device or system regularly for leaks.
- Solvent tray: The use of a solvent tray prevents liquids get from the bottles into the inside of the device.
- Eluent lines: Install capillaries and hoses in such a way that, in case of a leak, liquids cannot get into the interior of the devices underneath.
- In case of leakage: Switch off the system. Only take the device into operation if the cause of the leak has been resolved (see "9 Maintenance and care", p. 49).

## 2.7 Specific environments

### 2.7.1 Earthquake-endangered areas

In earthquake-endangered areas, do not stack more than 3 devices on top of each other. Otherwise there is risk of injury due to falling devices or loose parts.

### 2.7.2 Explosive environment

Never use the system in potentially explosive atmospheres without appropriate protective equipment. For more information, contact the KNAUER Customer Support.

### 2.7.3 Cooling room

You may operate the device in a cooling room. To prevent condensation, note the following instructions:

- Allow the device to acclimatize for min. 3 hours before taking it into operation.
- After taking into operation, the device should stay switched on.
- Avoid temperature fluctuations.

### 2.7.4 Wet room

The device must not be operated in wet rooms.

## 2.8 Maintenance, care and repair

- Avoiding electric shock: Before performing any maintenance and service work, disconnect the device from the power supply.
- Tools: Use only tools recommended or prescribed by the manufacturer.
- Spare parts and accessories: Only use original parts and accessories made by KNAUER or a company authorized by KNAUER.
- PEEK fittings: Use PEEK fittings only for a single port or brand-new PEEK fittings in order to avoid dead volume or not exactly fitting connections.
- Column care: Follow KNAUER or other manufacturer's instructions on caring for the columns (see [www.knauer.net/en/Systems-Solutions/LC-Columns](http://www.knauer.net/en/Systems-Solutions/LC-Columns))
- Used capillaries: Do not use any used capillaries elsewhere in the system in order to avoid dead volumes, not exactly fitting connections and spreading contamination.
- Safety features: The device may only be opened by the KNAUER Customer Support of KNAUER or any company authorized by KNAUER (see "1.4.1 Liability limitation", p. 2).
- For more information visit the KNAUER website: [www.knauer.net/hplc-troubleshooting](http://www.knauer.net/hplc-troubleshooting)

---

## 2.9 Service request form and decontamination report

Devices which are shipped without the completed document "Service request form and decontamination report" will not be repaired. If you would like to return a device to KNAUER, make sure to enclose the completed document: [www.knauer.net/servicerequest](http://www.knauer.net/servicerequest)

## 3. Product information

### 3.1 Features

The AZURA® detector DAD 6.1L/DAD 2.1L/MWD 2.1L (further on referred to as “detector” in general, or “DAD 6.1L”, “DAD 2.1L”, and “MWD 2.1L”) can be used for analytical, semi-preparative and preparative applications.

### 3.2 Scope of delivery

The following items should be included in the scope of delivery:

- Detector with test cell
- Power supply cable
- Accessories Kit AZURA® Detector DAD 6.1L/DAD 2.1L/MWD 2.1L
- Accessories Kit AZURA®

Valid documents:

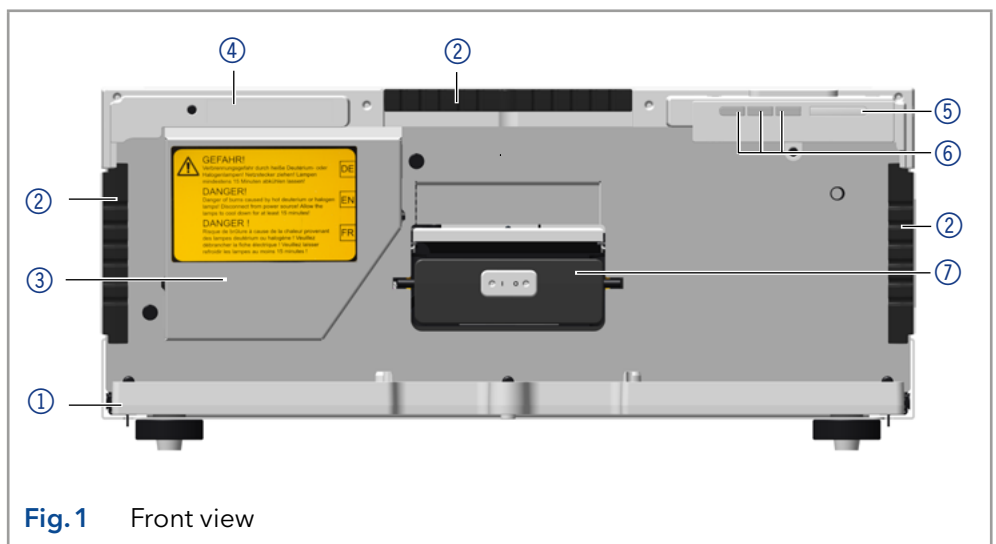
- Instructions
- Installation Qualification (“IQ”)
- Declaration of Conformity

### 3.3 Views

**Front view** On the front of the detector, there are the flow cell and the removable lamp cover for lamp replacement.

#### Legend

- ① Leak tray
- ② Capillary guide
- ③ Lamp cover
- ④ Serial number
- ⑤ Switch/standby key
- ⑥ Status LED
- ⑦ Flow cell

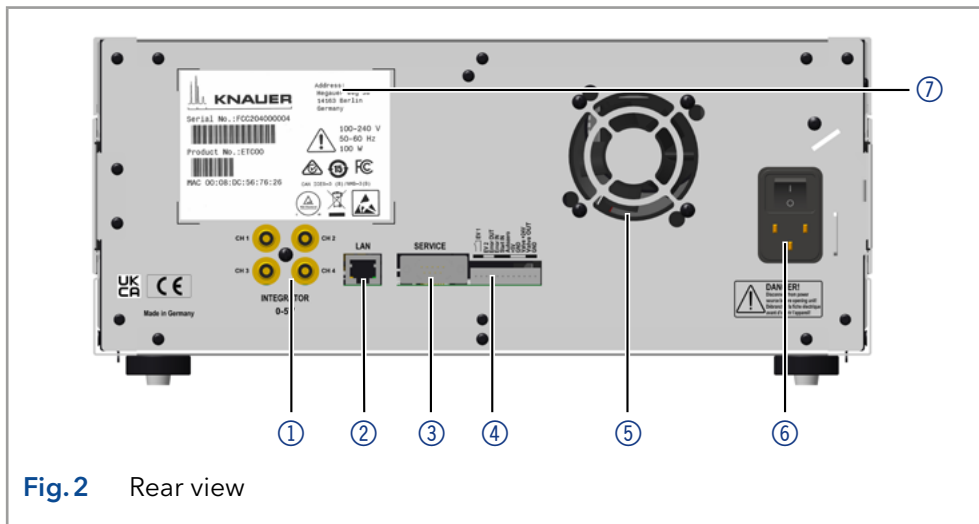


**Rear view** On the rear of the detector, the connectors for LAN and power plug are located, as well as the serial number of the device and the power switch (on/off).

**RS-232, service interface** Please note that the service interface is solely used for repair and maintenance tasks performed by service technicians. 3D data acquisition is not fully supported via this interface.

**Legend**

- ① Integrator outputs
- ② LAN connector
- ③ Service interface
- ④ Multi-pin connector
- ⑤ Fan
- ⑥ Power connection and power switch
- ⑦ Serial number and symbols (see chap. 3.5 on p. 11)



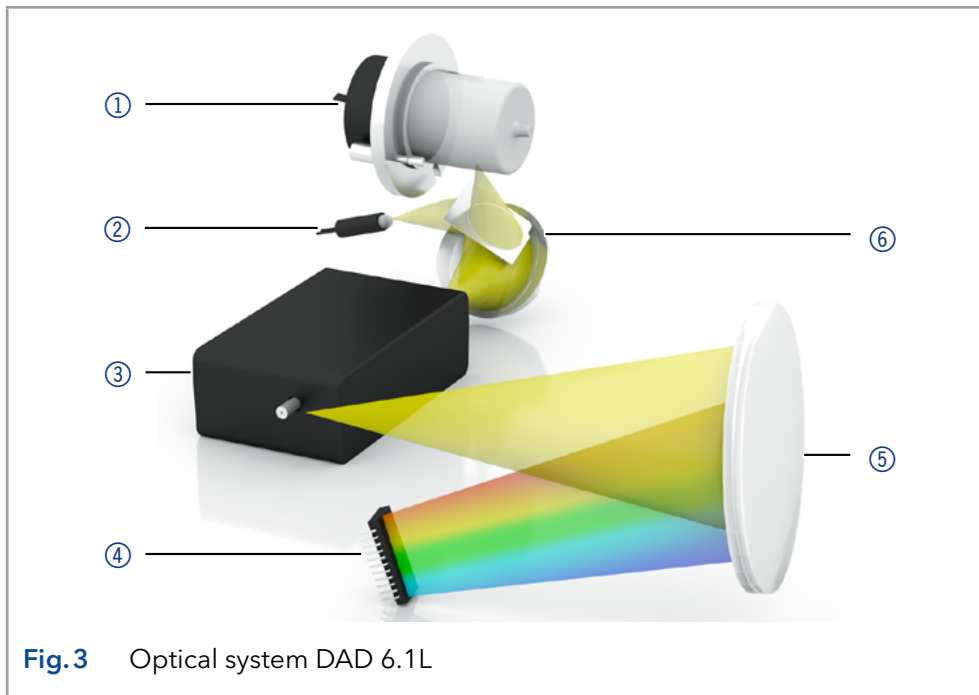
**Fig.2** Rear view

### 3.4 Performance overview

In an HPLC system, the detector serves to detect substances in liquids and determine their concentration. The sensitivity of the detector depends on the used flow cell.

**Legend**

- ① Deuterium lamp
- ② Halogen lamp
- ③ Flow cell
- ④ Diode array sensor
- ⑤ Diffraction grating
- ⑥ Mirror













**Fig.3** Optical system DAD 6.1L

- Optical module** The detectors measure the light absorption of the sample in the ultraviolet and visual spectra. The entire spectrum permeates the sample and afterwards is split up by a grate. The split light falls onto a geometric array of 1024 (DAD 6.1L) or 256 (DAD 2.1L, MWD 2.1L) separate photodiodes - the photodiode array.
- The optical system of the DAD 6.1L is depicted in figure 3. An active temperature control with 0.5 °C sensitivity ensures baseline stability for minimal baseline drift.
- Lamps** You can exchange the lamps quickly and easily without the need of a service technician (see section „9.5 Replacing the lamps“ on page 55).
- DAD 6.1L: Two light sources, a deuterium lamp and a halogen lamp, cover the entire UV-Vis wavelength range from 190 to 1000 nm.
  - DAD 2.1L, MWD 2.1L: One deuterium lamp covers the UV wavelength range from 190 to 700 nm.
- Mirror DAD 6.1L** Maximum light intensity over the entire UV-VIS range is provided by effectively mixing the light sources from the deuterium and halogen lamps with a mirror using Polka Dot technology.
- Flow cell** Various types of flow cells allow a wide range of applications. Flow cell cartridges with KNAUER PressureProof and KNAUER LightGuide technology as well as KNAUER Fiber Optics Technology are available (see chapter „13. Reorders“ on page 67).
- KNAUER LightGuide Flow Cell Cartridges combine a maximum light transmission (using total reflection) with a minimum cell volume to offer an ideal signal-to-noise ratio.
  - KNAUER PressureProof Flow Cell Cartridges are optimized for conventional and high flow HPLC and FPLC applications. These flow cells feature an increased pressure stability (up to 300 bar) and extended flow rate range (up to 20 ml/min).
  - KNAUER Fiber Optics Technology: Adapters for fiber optics are optionally available. Fiber optics allow separating the flow cell from the detector. This way, working with dangerous, explosive, or toxic materials becomes safer. Remote flow cells are recommended for preparative applications (high flow rates), in order to protect sensitive optical components from potential leakages.
- Data rate** The detector measures with a maximum data rate of 100 Hz. During the measurement, up to 100 spectra per second are recorded.
- Leak management** Integrated leak management drains liquids from leaks.
- GLP data** You can use the Mobile Control and the different software products (ClarityChrom®, OpenLAB®, or Chromeleon™) to display or read GLP data like operating hours, lamp operating hours, number of lamp ignitions, etc.
- You find a detailed description on how to display or read out GLP data in the respective software instructions.
- Upgrade MWD 2.1L** The multiwavelength detector can be upgraded to a diode array detector.



### 3.5 Symbols and signs

The following symbols and signs can be found on the device:

Symbol	Meaning
	Electric shock hazard. Failure to observe this warning may result in loss of life, serious injury or damage or destruction of the device.
	Electrostatic discharge hazard. Damages to system, device, or sensitive electronic components can occur.
	Obey maximum load for leak tray during transportation, installation and operation.
	A warranty seal is affixed to some devices. For more information see chap. 1.4.4 on p. 2.
	The device is covered by the Waste Electrical and Electronic Equipment Directive (WEEE Directive). It may not be disposed of as unsorted municipal waste and has to be collected separately. For more information see chap. 11 on p. 61.
	The device fulfills the product specific requirements of European directives.
	The device complies with the product-specific requirements of the United Kingdom.
	The device has successfully passed the TÜV tests for quality and safety. The TÜV Germany is a nationally recognized testing agency (NRTL) in Canada and the USA.
	The electromagnetic interference from the device is below the limits approved by the Federal Communications Commission (FCC).
	The device complies with the Australian EMV regulations.
<b>CAN ICES-3 (B)</b>	The device complies with Industry Canada license-exempt RSS standards.

## Symbol

## Meaning



The device can be used for 15 years according to its intended use before there is a risk that the contained substances may escape and thereby pose a risk to the environment and health.

部件名称	有毒及危险物质或元素					
	铅	汞	镉	铬(VI)	多溴联苯	多溴二苯醚
印刷电路板	O	O	O	O	O	O
机电部件	O	O	O	O	O	O
电缆和电线	O	O	O	O	O	O
金属部件	X	O	O	O	O	O
塑料部件	O	O	O	O	O	O
电池	O	O	O	O	O	O
显示	n/a	n/a	n/a	n/a	n/a	n/a
O = 表示部件中所有同质金属中的有毒和危险物质含量低于SJ/T 11363-2006中描述的浓度极限要求。(表示部件中所有同质金属中的有毒和危险物质含量低于SJ/T 11363-2006中描述的浓度极限要求。*)						
X = 表示部件中所有同质金属中的有毒和危险物质含量超过SJ/T 11363-2006中描述的浓度极限要求。(表示部件中所有同质金属中的有毒和危险物质含量超过SJ/T 11363-2006*中描述的浓度极限要求。*)						

Part Name	toxic and hazardous substances or elements					
	Pb	Hg	Cd	Cr(VI)	PBB	PBDE
PCB	O	O	O	O	O	O
Electromechanical parts	O	O	O	O	O	O
Cables & wires	O	O	O	O	O	O
Metal Parts	X	O	O	O	O	O
Plastic parts	O	O	O	O	O	O
Batteries	O	O	O	O	O	O
Display	n/a	n/a	n/a	n/a	n/a	n/a
O = Indicates that the content of the toxic and hazardous substances in all homogenous Materials of the part is below the concentration limit requirements as described in SJ/T 11363-2006. (Indicates that the content of the toxic and hazardous substances in all homogenous Materials of the part is below the concentration limit requirements as described in SJ/T 11363-2006.*)						
X = Indicates that the content of the toxic and hazardous substances in all homogenous Materials of the part is exceeds the concentration limit requirements as described in SJ/T 11363-2006. (Indicates that the content of the toxic and hazardous substances in all homogenous Materials of the part is exceeds the concentration limit requirements as described in SJ/T 11363-2006.*)						

## 4. Installation and initial startup

Before you determine the operation site, read the chapter "Technical Data" (see chapter 12 on page 62). There you will find all device-specific information on power supply, ambient conditions and humidity.



**Note:** The intended use be ensured only if the requirements for ambient conditions of the operating environment are met.

### 4.1 Unpacking

	Process
<b>Procedure</b>	1. Place the packaging in such a way that the lettering on the label is in the correct position.
	2. Check the packaging, the device and the accessories for transport damage.
	3. Check the scope of delivery. In the event of incomplete delivery, contact Technical Support immediately.
	4. When lifting, carrying or moving the device, grab the unit only from below on the sides. Do not hold onto front cover or leak tray, as these parts are loosely attached to the device.
<b>Next steps</b>	<ul style="list-style-type: none"> <li>■ Keep the included packing list for repeat orders.</li> <li>■ Keep the original packaging for safe storage or transportation.</li> </ul>

### 4.2 Ambient conditions

#### 4.2.1 Operation site

Observe the following requirements for the operation site so that the measurement results are not influenced:

- Place on a firm, level and straight surface.
- Protect against direct sunlight.
- Do not expose to air drafts such as air conditioning systems.
- Do not set up next to machines that cause floor vibrations.
- Keep from high frequency sources.
- Ensure adequate ventilation (see 4.2.3 on page 14 ).
- Avoid temperature fluctuations (see 4.2.2 on page 13 ).

#### 4.2.2 Ambient temperature

If the ambient temperature of the device is abruptly changed (e.g. when it is installed in a cooling chamber), condensation will form inside the device and may cause damage to the device. Allow the device to acclimate for 3 h, before it is connected to the power supply and taken into operation.

### 4.2.3 Space requirements

- Make sure that the power plug on the power supply (wall socket or power strip) is always accessible, so that the device can be disconnected from the power supply.
- Ensure adequate ventilation around the device, otherwise it may overheat and malfunction:
  - Min. 5 cm distance if another device is set on one side.
  - Min. 10 cm distance if further devices are set on both sides.
  - At least 15 cm to the cooler fan on the rear.
- The mounting of a small device to an AZURA L device with a mounting bracket does not affect the performance of either device. The space requirements specified in both device instructions do not apply in this case.

## 4.3 Power supply

### Power supply requirements

- Failure-free power supply: For failure-free operation, the electrical voltage must be free of fluctuations, residual currents, voltage peaks and electromagnetic interference. The device must receive sufficient voltage and reserve capacity.
- Check voltage: Only connect devices to a power supply whose voltage corresponds to the permissible voltage of the device.
- Power consumption: The nominal power of the connected devices must not exceed 50 % of the highest connected power capacity, since higher currents can flow briefly when the device is switched on.
- Main connection: The electrical power supply at the operation site must be connected directly to the nearest main power connection.
- Grounding: The connectors for the voltage must be grounded accordingly.

### Power supply cables and plugs

- Original parts: For power supply, use the supplied power cable and plug to meet the specifications which are described in the chapter "Technical Data" (see chapter 12 on page 62). Detachable power cables are not allowed to be replaced with other cable types.
- Country-specific plugs: Before switching on the device, check whether the supplied plug is approved for your country. Overview of the device- and country-specific plug types from KNAUER: [www.knauer.net/plugs](http://www.knauer.net/plugs)
- Power strips: If several devices are connected to one power strip, always consider the maximum power consumption of each device.
- Access to power supply: Make sure that the power plug on the power supply (wall socket or power strip) is always accessible, so that the device can be disconnected easily from the power supply.
- Damaged power supply cables and plugs: For safety reasons, damaged or faulty cables and plugs must not be used to connect the device to the power supply. Replace defective cables and plugs only with KNAUER accessories.

## 4.4 Connecting the leak management

The leak management consists of the leak sensor and the drainage system. The drainage system ensures that escaping liquids flow into a waste bottle. If there is too much liquid, the red LED starts flashing. Both the device and the data acquisition via chromatography software are stopped.

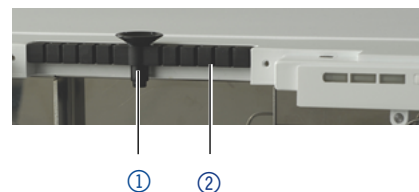
**Prerequisite** ■ Remove the front cover.

### Procedure

#### Process

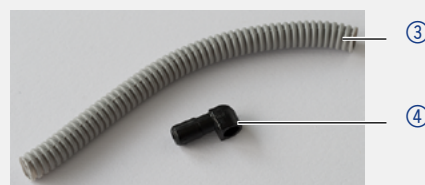
#### Figure

1. Carefully push the funnel ① into the center opening of the capillary guide ②.



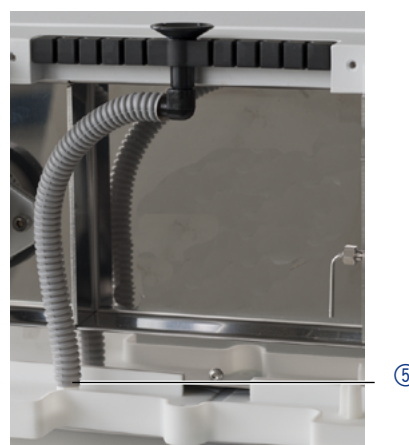
**Fig. 4** Funnel and capillary guide

2. Push the long ending of the first nozzle ④ into the hose ③.



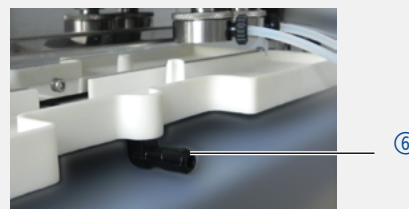
**Fig. 5** Hose and nozzle

3. Afterwards, push the nozzle onto the funnel.
4. Push the other end of the hose onto the nozzle ⑤ of the leak tray.



**Fig. 6** Hose connected to device

5. Attach the waste nozzle ⑥ to the bottom unit of your system. This does not apply if the bottom unit is an autosampler.
6. Attach the wastehose to the waste nozzle and connect it to the waste container.
7. Place the waste container below the devices.



**Fig. 7** Leak tray with nozzle

**Next step** ■ Attach the front cover.

## 4.5 Inserting the flow cell

**i** **Note:** Pay attention to the compatibility of the flow cell.

Before taking a flow cell filled with solvent into operation, please make certain that the used eluent is miscible with that one used previously. Otherwise purge the flow cell with a medium miscible with both the eluents.

**Prerequisites**

- No flow cell or test cell is installed.
- The device is switched off.

**Practical tip** Unscrew the capillary for easier handling.

### ⚠ WARNING

#### Eye injury

Irritation of retina through UV light. High-energy UV light can leak out from the flow cell or the fiber optic connectors.

→ Switch off the detector or the lamps.

### NOTICE

#### Performance decrease

Any components in the light path like fiber optic ends become contaminated when touched with fingers.

→ Avoid touching the ends without gloves.

→ Use alcohol and a cotton bud for cleaning.

### Process

#### Step

Place the flow cell into the opening and slide to the back until it clicks into place inside the device.

#### Figure



**Fig. 8** Flow cell

**Next step** Connect the capillaries.

### 4.5.1 Inserting the flow cell with fiber optics

KNAUER fiber optic cables are extremely robust. Nevertheless fiber optic cables are sensitive to bending. The minimum bending radius is 100 mm (short term: 70 mm).

Observe the following regarding the use of fiber optics:

- UV light will cause the fiber optic to become blind with time (solarization), making them no longer suitable for use.
- Do not touch the ends of the fiber optic with your fingers, as this could falsify the measurement.
- Handle the fiber optic with care, avoid impacts or hard actions.
- Move the fiber optic carefully without using pressure or bending it.
- The flow cells with fiber optics are connected via an adapter.

**Prerequisites** No flow cell or test cell is installed.

**Auxiliary material** Screw-type cap fittings for the fiber optics

#### WARNING



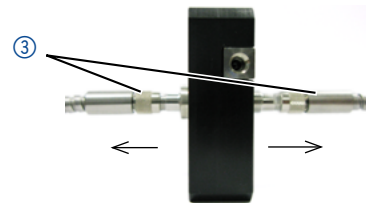
##### Eye injury

Irritation of retina through UV light. High-energy UV light can leak out from the flow cell or the fiber optic connectors.

→ Switch off the detector or the lamps.



**Note:** Other optical parts should never be touched without wearing gloves because otherwise contaminations may reduce light intensity. Contaminated parts may be cleaned with a soft cloth and isopropanol.

Process	Steps	Figure
	<ol style="list-style-type: none"> <li>1. Remove the cap fittings ① from the adapter.</li> <li>2. Place the adapter into the opening. Slide the adapter to the back until it clicks into place inside the device.</li> </ol>	 <p><b>Fig. 9</b> Fiber optics adapter</p>
	<ol style="list-style-type: none"> <li>3. Remove the screw-type cap fittings ② from the end of the fiber optics.</li> <li>4. Manually, screw the fiber optics to the adapter.</li> </ol>	 <p><b>Fig. 10</b> Cap fitting on the fiber optics</p>
	<ol style="list-style-type: none"> <li>5. Remove the cap fittings from the flow cell.</li> <li>6. Manually, screw the fiber optics ③ to the flow cell.</li> </ol>	 <p><b>Fig. 11</b> Fitting of the fiber optics on the flow cell</p>

**Next step** Connect the capillaries.

## 4.6 Connecting the capillaries

Capillaries connect the detector with the column and waste or more subsequent operating detectors. For the LightGuide flow cell connectors, we recommend PEEK capillaries and PEEK fittings.

- Prerequisites**
- The flow cell was inserted.
  - Screw-type cap fittings and cap fittings were removed.



**Note:** The KNAUER LightGuide flow cell cartridges have unisex input and output connections.

### NOTICE

#### Component defect

Damage to components due to excessive tightening possible. Observe the torque of the screw connection.

- Use 5 Nm torque for stainless steel fittings.
- Use 1 Nm torque for PEEK fittings.

### Process

#### Steps

1. Push the capillary ① through the fitting ②.
2. Slide the lock ring ③ over the tubing. Note that the tapered end of the lock ring has to point to the seal ring ④.
3. Attach the seal ring ④.

#### Figure

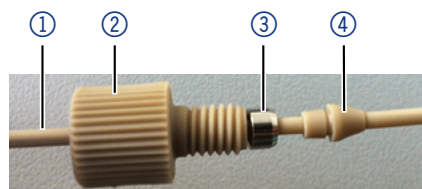
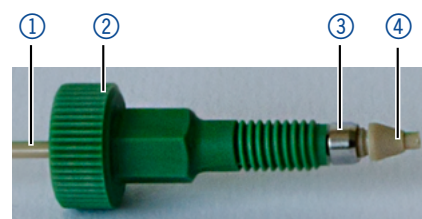


Fig. 12 Capillary fittings

4. Fasten the capillary at the flow cell ④ fingertight.

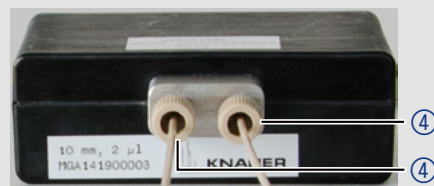


Fig. 13 Flow cell with capillary

**Next step** Bring the device into operation.

#### Using the PEEK fittings

PEEK fittings withstand a maximum pressure of 400 bar. Note the torque of 0.5 Nm.



## 4.7 Computer control



**Note:** HPLC devices from KNAUER only work with IP addresses, which have been assigned by IPv4. IPv6 is not supported.

This chapter describes how to set up a chromatography system in a local area network (LAN) and how a network administrator can integrate this LAN into your company network. The description applies to the operating system Windows® and all conventional routers.



**Note:** When using PurityChrom®, static IP addresses are needed (see chapter 4.7 on page 19).

### 4.7.1 Setting up LAN

To set up a LAN, we recommend to use a router. That means the following steps are required:

Process				
<table border="0"> <tr> <td style="vertical-align: top;"><b>Procedure</b></td> <td> <ol style="list-style-type: none"> <li>1. On the computer, go to the control panel and check the LAN properties.</li> <li>2. Hook up the router to the devices and the computer.</li> <li>3. Set up the router for the computer network.</li> <li>4. Install the chromatography software.</li> <li>5. Switch on the device and run the chromatography software.</li> </ol> </td> </tr> <tr> <td><b>Next step</b></td> <td>Configure LAN properties (see section 4.7.2).</td> </tr> </table>	<b>Procedure</b>	<ol style="list-style-type: none"> <li>1. On the computer, go to the control panel and check the LAN properties.</li> <li>2. Hook up the router to the devices and the computer.</li> <li>3. Set up the router for the computer network.</li> <li>4. Install the chromatography software.</li> <li>5. Switch on the device and run the chromatography software.</li> </ol>	<b>Next step</b>	Configure LAN properties (see section 4.7.2).
<b>Procedure</b>	<ol style="list-style-type: none"> <li>1. On the computer, go to the control panel and check the LAN properties.</li> <li>2. Hook up the router to the devices and the computer.</li> <li>3. Set up the router for the computer network.</li> <li>4. Install the chromatography software.</li> <li>5. Switch on the device and run the chromatography software.</li> </ol>			
<b>Next step</b>	Configure LAN properties (see section 4.7.2).			

### 4.7.2 Configuring LAN settings

The LAN uses only one server (which is normally the router) from that the devices automatically receive their IP address.

<b>Prerequisites</b>	<ul style="list-style-type: none"> <li>■ In Windows, power saving, hibernation, standby, and screen saver must be deactivated.</li> <li>■ In case you use an USB-to-COM box, the option "Allow the computer to turn off this device to save power" in the device manager must be deactivated for all USB hosts.</li> <li>■ Applies to all LAN devices: Disable the setting for the network adapter in Device Manager "Allow the computer to turn off this device to save power".</li> </ul>
----------------------	---

Process		
<table border="0"> <tr> <td style="vertical-align: top;"><b>Procedure</b></td> <td> <ol style="list-style-type: none"> <li>1. In Windows, open &lt;Network and Sharing Center&gt;.</li> <li>2. Double-click on &lt;LAN connection&gt;.</li> <li>3. Click on the button &lt;Properties&gt;.</li> <li>4. Select &lt;Internet Protocol version 4 (TCP/IPv4)&gt;.</li> <li>5. Click on the button &lt;Properties&gt;.</li> </ol> </td> </tr> </table>	<b>Procedure</b>	<ol style="list-style-type: none"> <li>1. In Windows, open &lt;Network and Sharing Center&gt;.</li> <li>2. Double-click on &lt;LAN connection&gt;.</li> <li>3. Click on the button &lt;Properties&gt;.</li> <li>4. Select &lt;Internet Protocol version 4 (TCP/IPv4)&gt;.</li> <li>5. Click on the button &lt;Properties&gt;.</li> </ol>
<b>Procedure</b>	<ol style="list-style-type: none"> <li>1. In Windows, open &lt;Network and Sharing Center&gt;.</li> <li>2. Double-click on &lt;LAN connection&gt;.</li> <li>3. Click on the button &lt;Properties&gt;.</li> <li>4. Select &lt;Internet Protocol version 4 (TCP/IPv4)&gt;.</li> <li>5. Click on the button &lt;Properties&gt;.</li> </ol>	

**Process**

6. Check the settings in the tab <General>. The correct settings for the DHCP client are:
  - a) Obtain an IP address automatically
  - b) Obtain DNS server address automatically
7. Click on the button <OK>.

**Next step** Connect devices (see section 4.7.3).

### 4.7.3 Connecting devices to the LAN

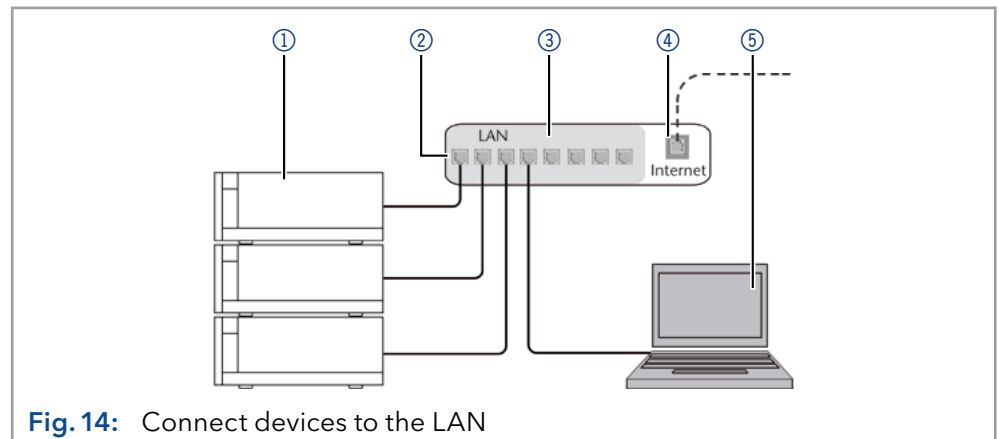
A router ② has several LAN ports ③ and one WAN port ④ that can be used to integrate the LAN into a wide area network (WAN), e.g. a company network or the Internet. In contrast, the LAN ports serve to set up a network from devices ① and a computer ⑤. To avoid interference, we recommend operating the chromatography system separately from the company network.



**Note:** You will find patch cables for each device and the router in the accessories kit. To connect the router to a LAN, an additional patch cable is required, which is not supplied within the scope of delivery.

#### Legend

- ① Devices
- ② Router
- ③ LAN ports
- ④ WAN/Internet connection
- ⑤ Computer



**Fig. 14:** Connect devices to the LAN

- Prerequisites**
- The computer is switched off.
  - There is a patch cable for each device and the computer.

**Process**

- Procedure**
1. Use the patch cable to connect the router and the computer. Repeat this step to connect all devices.
  2. With additional patch cables, connect all devices individually with the router.
  3. Use the power supply to connect the router to the mains power system.

**Next step** Set the router properties (see section 4.7.4).

### 4.7.4 Configuring the router

The router is preset at the factory. Information about address, user name and password is noted in the router manual: [www.knauer.net/en/Support/Library/PC-hardware](http://www.knauer.net/en/Support/Library/PC-hardware)

	Process
<b>Procedure</b>	1. To open the router configuration, start your Internet browser and enter the IP address (does not apply for all routers).
	2. Enter user name and password.
	3. Configure the router as DHCP server.
	4. In the router configuration, check the IP address range and make changes if necessary.



**Note:** If the IP address range has been changed, it is essential to note this information on the router.

**Result** Once the router has assigned IP addresses to all devices, the chromatography software can be used to remotely control the system.

### 4.7.5 Integrating LAN into the company network

A network administrator can integrate the LAN into your company network. In this case you use the WAN port of the router.

**Prerequisites**

- There is a patch cable for the connection.

	Process
<b>Procedure</b>	1. Make sure that there is no overlap between the IP addresses of the router and the corporate network.
	2. In case of an overlap, change the IP address range of the router.
	3. Use the patch cable to connect the router WAN port to the company network.
	4. Restart all devices, including the computer.

**Result** The LAN is now integrated into the company network.

### 4.7.6 Controlling several systems separately in LAN

Devices connected to a LAN communicate through ports, which are part of the IP address. If more than one chromatography systems are connected to the same LAN and you plan on controlling them separately, you can use different ports to avoid interference. Therefore, the port number for each device must be changed and this same number must be entered into the device configuration of the chromatography software. We recommend to use the same port number for all devices in the same system.



**Note:** The port is set to 10001 at the factory. You must use the same numbers in the device configuration of the chromatography software as in the device, otherwise the connection fails.

	Process
<b>Procedure</b>	1. Find out port number and change it on the device.
	2. Enter the port number in the chromatography software.

**Result** The connection is established.

## 4.8 Setting IP addresses via software



**Note:** Check the IT security standards for your lab before intervening in the LAN settings.

### PurityChrom®

Static IP addresses are required to run certain chromatography software, e.g. Purity Chrom®. For a comprehensive overview on how to set static IP addresses for PurityChrom®, refer to the document "PurityChrom® Installation Guide" on the PurityChrom® installation CD.

For Mobile Control and Firmware Wizard, it is possible to set a fixed (static) or dynamic (DHCP) IP address via software.

### 4.8.1 Mobile Control: Setting a static IP address



**Note:** The device is preset to a dynamic address (DHCP). To ensure a constant LAN connection between the chromatography software and the instrument, we recommend switching the instrument to a static IP address for certain applications. More information about LAN settings can be found in the [Mobile Control Software Instructions](#).

#### Prerequisites

- The device is switched on.
- Mobile Control is installed and running.
- The connection between Mobile Control and the device has been established.

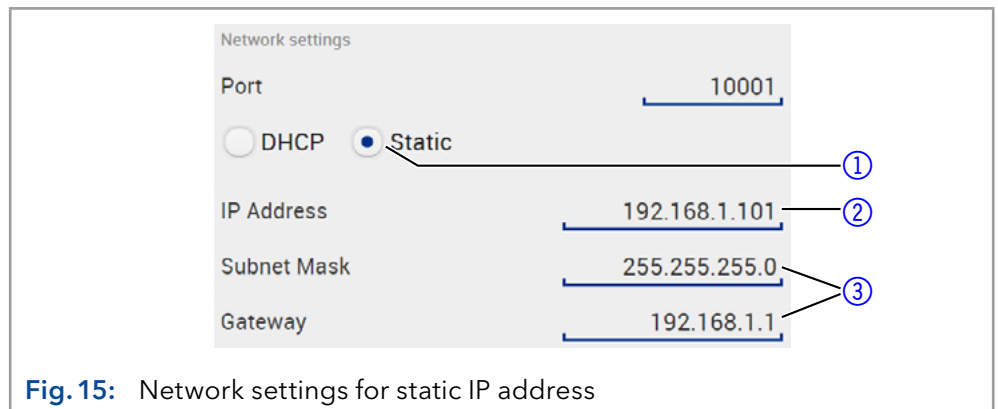
#### Process

#### Procedure

1. In Mobile Control, click <Settings>.
2. On the <General> tab, choose the device name.
3. In <Network Settings>, choose the setting <Static> ① .
4. Enter the IP address into the text box <IP Address> ② .
5. If necessary, change the subnet mask and the gateway ③ .
6. Click in the top right corner.
7. Restart the device (recommended).

#### Legend

- ① IP address mode
- ② Text box for IP address
- ③ Text field for subnet mask/gateway





**Fig. 15:** Network settings for static IP address

**Result** The device is now accessible via the static IP address.

## 4.8.2 Mobile Control: Setting a dynamic IP address via device name

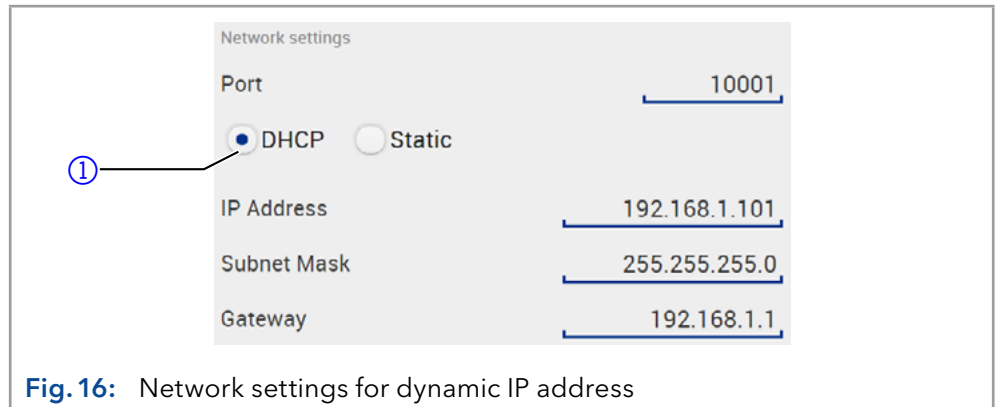
- Prerequisites**
- The device is switched on.
  - Mobile Control is installed and running.
  - The connection between Mobile Control and the device has been established.

### Process

- Procedure**
1. In Mobile Control, click  <Settings>.
  2. On the <General> tab, choose the device.
  3. In <Network Settings>, choose the setting <DHCP> ①.
  4. Click  in the top right corner.
  5. Restart the device (recommended).

### Legend

- ① IP address mode




**Fig. 16:** Network settings for dynamic IP address

**Result** The device is now accessible via a dynamic IP address.

## 4.8.3 Mobile Control: Setting a dynamic IP address via device serial number

- Prerequisites**
- The device is switched on.
  - Mobile Control is installed and running.
  - The connection between Mobile Control and the device has been established.

### Process

- Procedure**
1. In Mobile Control, click  <Settings>.
  2. In <Network Settings>, click <Reset>. The window <Reset communication settings> opens.
  3. Enter the serial number of the device into the text field.
  4. Click <OK>. The device is now reset to default settings.
  5. Restart the device (recommended).

**Result** The device is now accessible via a dynamic IP address.

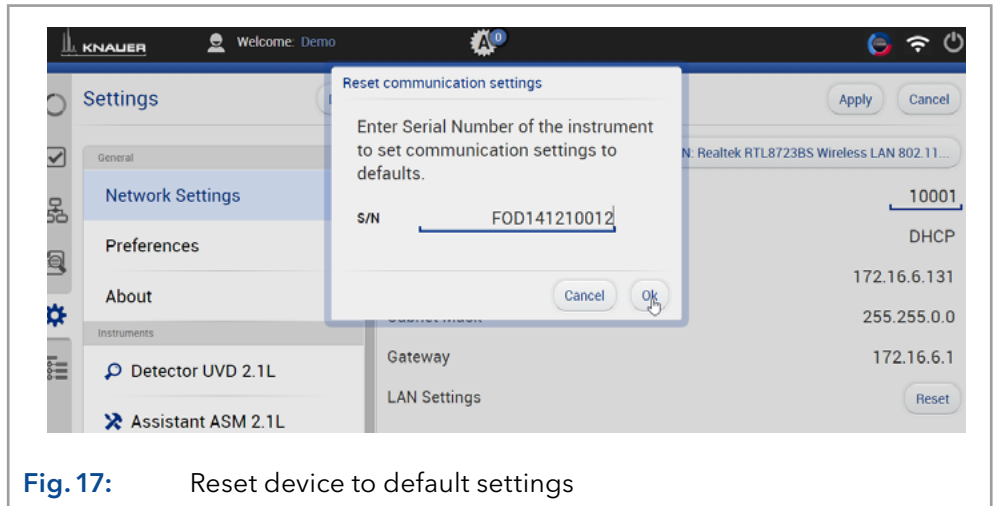


Fig. 17: Reset device to default settings

### 4.8.4 Firmware Wizard: Setting a static IP address



**Note:** More information about LAN settings can be found in the [Mobile Control Software Instructions](#) in the chapter "Firmware Wizard".

#### Legend

- ① Text box for serial number of the device
- ② Setting IP address manually
- ③ Text box for IP address
- ④ Text box for subnet mask & gateway
- ⑤ Confirm change

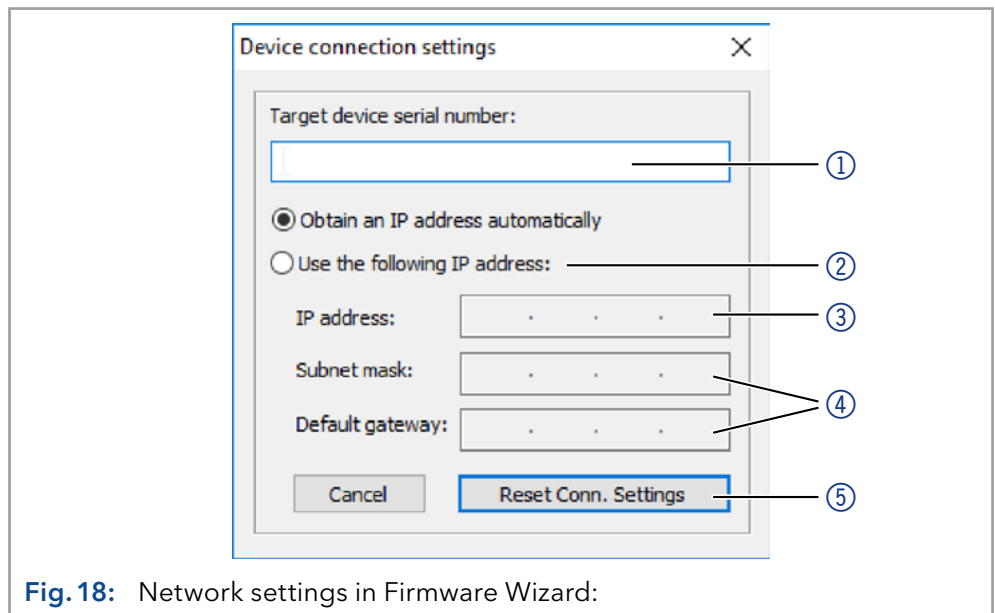


Fig. 18: Network settings in Firmware Wizard:

#### Prerequisites

- The device is switched on.
- Firmware Wizard is installed and running.

#### Process

#### Procedure

1. In Firmware Wizard, click <Reset LAN Settings...>.
2. The window <Device connection settings> opens. Enter serial number of the device into the text field <Target device serial number> ①.
3. Select option <Use the following IP address> ②.
4. Enter the IP address into the text field <IP address> ③.
5. Optionally, adjust subnet mask and gateway ④.

**Process**

6. Click <Reset Conn. Settings> ⑤ to accept changes.
7. Restart the device (recommended).

**Result** The device is now accessible via the static IP address.

### 4.8.5 Firmware Wizard: Setting a dynamic IP address

- Prerequisites**
- The device is switched on.
  - Firmware Wizard is installed and running.

**Process****Procedure**

1. In Firmware Wizard, click <Reset LAN Settings...>.
2. The window <Device connection settings> opens. Enter serial number of the device into the text field <Target device serial number> ①.
3. Select option <Obtain an IP address automatically> ②.
4. Click <Reset Conn. Settings> ⑤ to accept changes.
5. Restart the device (recommended).

**Result** The device is now accessible via a dynamic IP address.

## 4.8.6 Remote control

On the rear panel of the detectors an electrical connector socket is located which serves to send or receive signals from other instruments. For example start signals from an injection valve or an autosampler can be put to the START input. All voltages have to be mounted between GROUND and the corresponding event.

### NOTICE

#### Electronic defect

Electrostatic discharge can destroy the electronics.

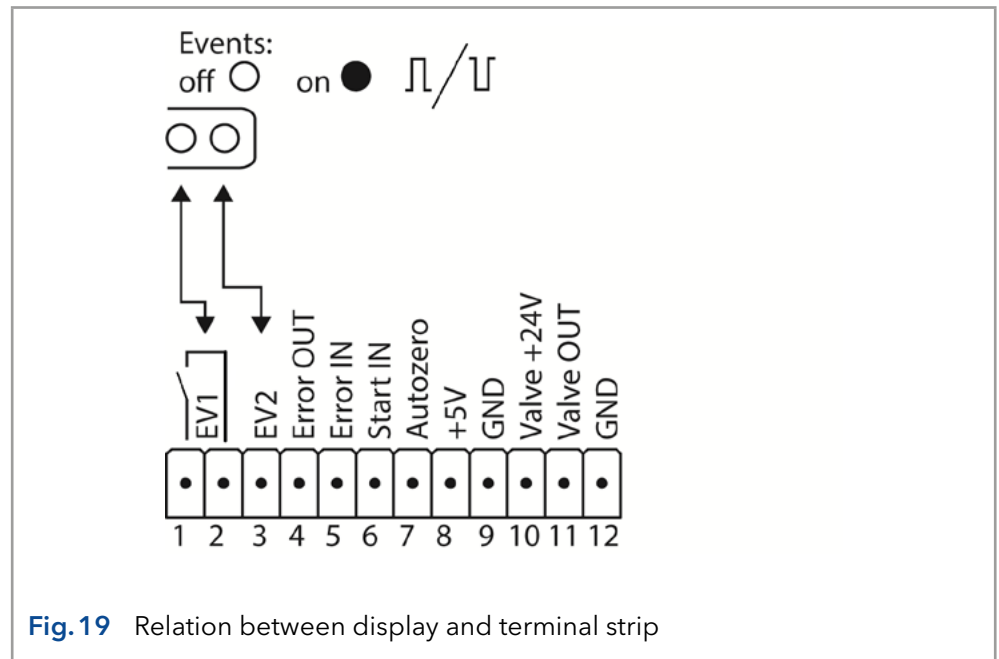
→ Wear a protective bracelet against electrostatic discharge and ground.

For test purposes or in some other cases, it can make sense to manually enter these signals.

- sending control signals (Events) to external devices
- opening and closing contacts
- activating 500 ms pulses

The following remote signals can be received and sent:









- for receiving start, control, and error signals from external devices
- for sending start, control and error signals to external devices



**Fig. 19** Relation between display and terminal strip



### 4.8.7 Connections to the terminal strip

Connection	Function
 EV 1 (Event 1)	Relay Contact The contact is on a floating basis. Its setting depends on the settings in Mobile Control or software. Steady-rate signal: <ul style="list-style-type: none"> <li>▪ passive = open relay contact </li> <li>▪ active = closed relay contact </li> </ul> Pulse: <ul style="list-style-type: none"> <li>▪ Closed relay contact for at least 1000 ms </li> </ul> Permissible load of the relay contact: 1 A/ 24 V DC
EV 2 (Event 2)	OC Output, with external pull-up up to 5V (20mA) Levels: <ul style="list-style-type: none"> <li>▪ passive 5 V </li> <li>▪ active 0 V </li> </ul> Output is active until the Error condition has been eliminated.
Error OUT	OC Output, with external pull-up up to 5V (20mA) Levels: <ul style="list-style-type: none"> <li>▪ passive 5 V </li> <li>▪ active 0 V </li> </ul> Output is active until the Error condition has been eliminated.
Error IN	TTL Input <ul style="list-style-type: none"> <li>▪ Low active</li> </ul> Secure switching threshold at least 10 mA After receiving a signal (short-circuit to ground) from an external device, an error message appears and the device stops.
Start IN	TTL Input <ul style="list-style-type: none"> <li>▪ Low active</li> </ul> Secure switching threshold at least 10 mA After receiving a signal (short-circuit to ground) from an external device, the device starts. If controlled with software, an electronic trigger is send through the LAN.

Connection	Function
Autozero	TTL Input <ul style="list-style-type: none"> <li>Low active</li> </ul> Secure switching threshold at least 10 mA A signal (short-circuit to ground) sets the measuring signal to zero.
+5 V	Provides a voltage of 5 V with respect to GND. This makes it possible to supply a load that is switched by an EVENT. Protection: 5 V-50 mA
GND	Reference point of the voltage at the signal inputs.
+24 V Valve	Event-controlled switching of 24 V Protection against GND: 24 V-200 mA
Valve OUT	Output is active until the valve condition has been eliminated.
GND	Reference point of the voltage at the signal inputs.

#### 4.8.8 Connecting the pin header

To control one device through another, the pin header is used. To use remote control, you have to connect cables to the pin header. The single ports are used to exchange control signals.

- Prerequisites**
- The device is switched off.
  - The power plug is disconnected from the device.
- Tools**
- Depressor tool

#### NOTICE

##### Electronic defect

Connecting cables to the multi-pin connector of a switched on device causes a short circuit.

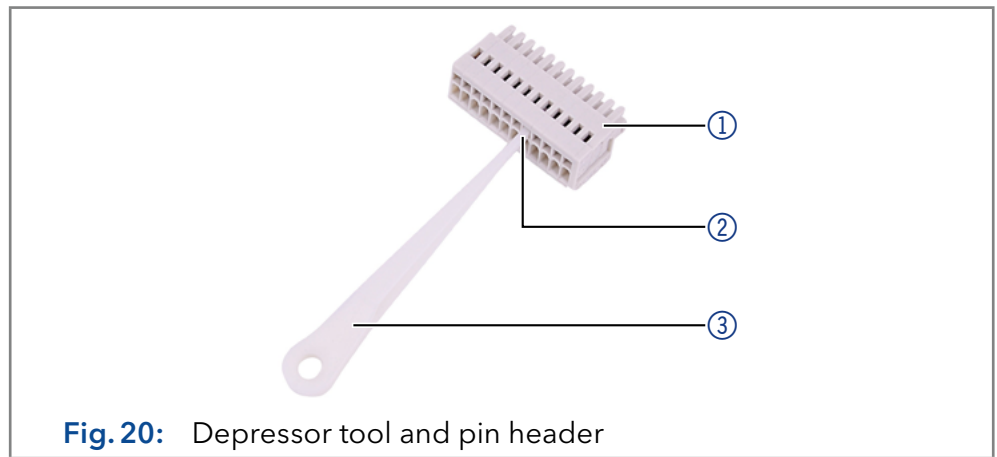
- Turn off the device before connecting cables.
- Pull the power plug.

#### NOTICE

##### Electronic defect

Electrostatic discharge can destroy the electronics.

- Wear a protective bracelet against electrostatic discharge and ground.



**Fig. 20:** Depressor tool and pin header

### Process

1. Insert the depressor tool ③ in an upper small opening at the front of the pin header ① .
2. Insert the cable into the opening ② underneath the inserted depressor tool
3. Pull out the depressor tool.

**Next steps** Check whether the cables are tightly attached. Press the pin header onto the connector. Finish the installation. Bring the device into operation.

### 4.8.9 Integrator connector

The integrator output supplies the current signal value as an analog voltage (max. 5 V). The integrator output is connected to other instruments with the analog connection cable or other special connection cables.

For details on the integrator connector, see the list below:

- Non-bipolar
- 4 channel
- 0 to 5 V
- DAC 16 bit
- Scalable
- Adjustable to offset

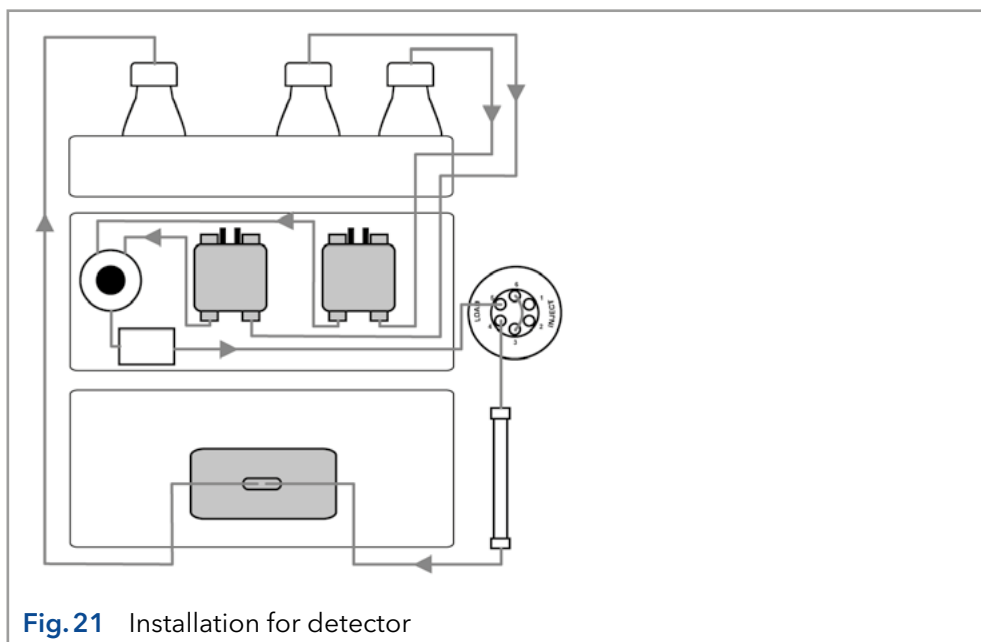
## 4.9 Integrating the detector into the system

To integrate the detector into a system, note the ambient conditions found in the chapter „12. Technical data“ on page 62, as well as the ambient conditions of other devices to be integrated into that system.

The detector is integrated into the HPLC flow system by connecting the capillary to the flow cell and the HPLC system.

**Torque** Stainless steel fittings are tightened with 5 Nm, PEEK fittings are tightened with 0.5 Nm.

### Capillary layout



## 4.10 Pre-installed capillaries

Pre-installed stainless steel and PEEK capillaries are color-coded according to their inner diameter.

Marker color	Material	Inner diameter
Red	Stainless steel	0.1 mm
Yellow	Stainless steel	0.18 mm
Blue	Stainless steel	0.25 mm
Black	Stainless steel	0.4 mm
Red	PEEK	0.1 mm
Yellow	PEEK	0.18 mm
Blue	PEEK	0.25 mm
Orange	PEEK	0.5 mm



**Note:** PEEK capillaries are not suitable for use with pure acetonitrile. Acetonitrile can cause capillaries to crack or rupture.

## 5. Operation

### 5.1 Initial startup

Use this checklist to determine whether the detector is ready for initial startup:

- Device is positioned in the correct location.
- The power plug is connected.

If the device is part of an HPLC system, you should also note the following:

- The network connection to the router is established
- The chromatography software has been installed by KNAUER or a company authorized by KNAUER.
- A flow cell is inserted.
- The capillaries are connected.

### 5.2 Switch on



**Note:** For warm-up time information see page 36.

#### Prerequisites

- Installation is completed.
- A clean flow cell was inserted.

#### NOTICE

##### Device defect

Changes of the ambient temperature cause condensation inside the device.

→ Allow device to acclimate for 3 h before connecting to power supply and taking into operation.

#### Process

##### Steps

1. On the rear of the device, plug the power cable into the power connector ②.
2. Plug in the power supply.
3. On the rear of the device, switch on the detector using the power switch ①.

##### Figure



**Fig. 22** Power switch with female connector at the rear panel

#### Result

The detector starts its self-validation. If the self-validation has been successfully completed, the LEDs on the right and in the center light up green.

#### Next step(s)

Bring the detector into operation.

## 5.3 Software operation

To operate the device with software, you have to establish a connection between the LAN port and a computer.

### 5.3.1 Control methods

The device can be operated with

- Mobile Control
- OpenLAB® EZChrom Edition
- ClarityChrom®
- PurityChrom®
- Chromeleon™



**Note:** It is not possible to use 2 control methods simultaneously. If the device is connected to the software, it cannot be controlled via Mobile Control. The device status can however be monitored.

You find more information about supported software packages and firm-ware versions on the KNAUER web page: [www.knauer.net/softwarecontrol](http://www.knauer.net/softwarecontrol)

You find a detailed description on chromatography software in the corresponding software instructions.



**Note:** 3D data acquisition via RS-232 is not possible.

### 5.3.2 Operating with Mobile Control

The Mobile Control is a device control software which can be installed on your computer or tablet. To control the device using the Mobile Control, connect the computer or tablet with a Windows operating system to a wireless LAN router.

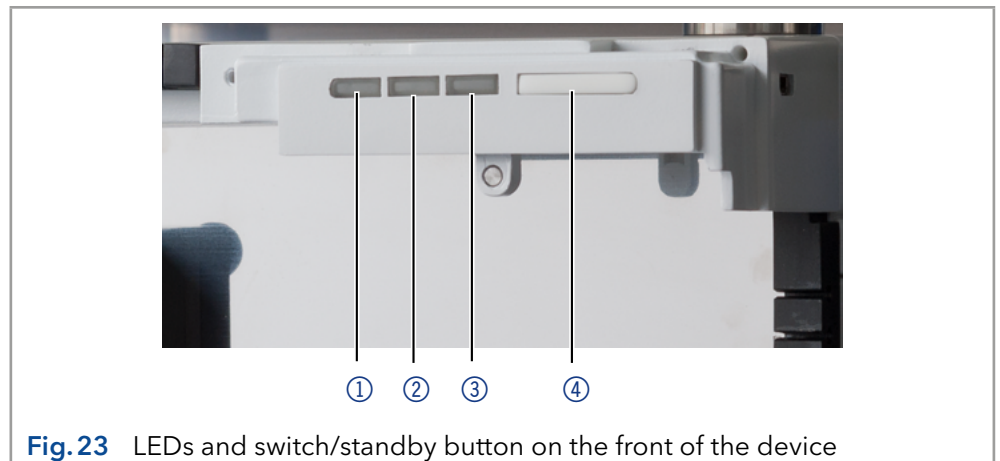
Data transfer between device and Mobile Control is actualized through wireless LAN. You find a detailed description on the Mobile Control in its accompanying software instructions.

## 5.4 Meaning of the LEDs

There are three LEDs and a switch on the front of the device.

### Legend

- ① Left LED
- ② Center LED
- ③ Right LED
- ④ Switch/Standby button



**Fig. 23** LEDs and switch/standby button on the front of the device

The LEDs can have different colors depending on the operating conditions.

**Standby** To start the standby, keep the standby button pressed for 5 seconds.



**Note:** Malfunctioning system after repeated standby possible. After repeatedly using standby, restart the device using the power switch to reset the device's data storage.

	Color	Status	Operation
<b>Left LED</b>	Red	Error	<ul style="list-style-type: none"> <li>Check the system.</li> <li>Shortly press the switch to deactivate the error message.</li> </ul>
	Green	3D data are acquired.	
<b>Center LED</b>	Does not light	The lamp has been switched off or the internal validation did not pass.	
	Flashes green	The lamp/lamps are initializing or the validation is progressing.	<ul style="list-style-type: none"> <li>Wait until the lamp is running or the validation is finished.</li> </ul>
	Green	The deuterium lamp is active and the internal validation has passed.	
<b>Right LED</b>	Green	The device has been switched on.	
	Blue	The device is in standby	<ul style="list-style-type: none"> <li>Press the standby button to end the standby.</li> </ul>

## 5.5 Default settings

Using the Mobile Control software, you can reset the detector to its default settings.

Parameter	Setting
Network	LAN DHCP, port 10001
Lamps	Deuterium ON, Halogen OFF (DAD 6.1L only)
Time constant	2 s
Channels	Channel 1: WL = 254 nm, BW = 8 nm
Reference correction	Reference channel enabled for channel 2, WL = 360 nm, BW = 30 nm
Extended linear range	OFF
Analog out	Offset 1 = 0.00 mV, Scale 1 = 1 AU/V
Flow cell	Test cell
Event check	All events deactivated (o)

Parameter	Setting
Date/Time	Current date/time
Wake-up	Current date/time
Leak sensor	ON, Sensitivity = low

## 5.6 GLP

The following GLP data for the instruments can be found in your software:

	GLP Data	Units	Explanation
<b>Device information</b>	Serial number		FOJYYWWXXXXXX (DAD 6.1L) FOUYYWWXXXXXX (DAD 2.1L) FOGYWWXXXXXX (MWD 2.1L)
	Firmware version		Current device firmware version
	Operating time	h	Running hours from manufacture
	Installation date		Manufacture date
	Last service date		
<b>Optical properties</b>	Optical bandwidth at 656 nm [FWHM]	nm	
	Optical bandwidth at 253 nm [FWHM]	nm	
	Stray light	AU	
	Lower spectral limit	nm	
	Upper spectral limit	nm	
	Number of shutter switches		
<b>Wavelength accuracy</b>	Integration time	ms	
	Holmium line at target wavelength 1	nm	
	Holmium line at target wavelength 2	nm	
	Deuterium beta line at 486.0 nm	nm	
<b>Lamps - power supply</b>	Deuterium alpha line at 656.1 nm	nm	
	Serial number		
	Operating time		
	Firmware version		
	Supply number		Indicates how often the lamp power supply has been changed since manufacture.



	GLP Data	Units	Explanation
<b>Lamps - deuterium lamp</b>	Serial number		
	Operating time	h	
	Starts		
	Lamp number		Indicates how often the lamp has been changed since manufacture.
	Installation date		
<b>Lamps - halogen lamp (only DAD 6.1L)</b>	Serial number		
	Operating time	h	
	Starts		
	Lamp number		Indicates how often the lamp has been changed since manufacture.
<b>Leak sensor</b>	Serial number		Leak sensor serial number
	Firmware version		Current leak sensor firmware version

## 6. Optimizing the detector

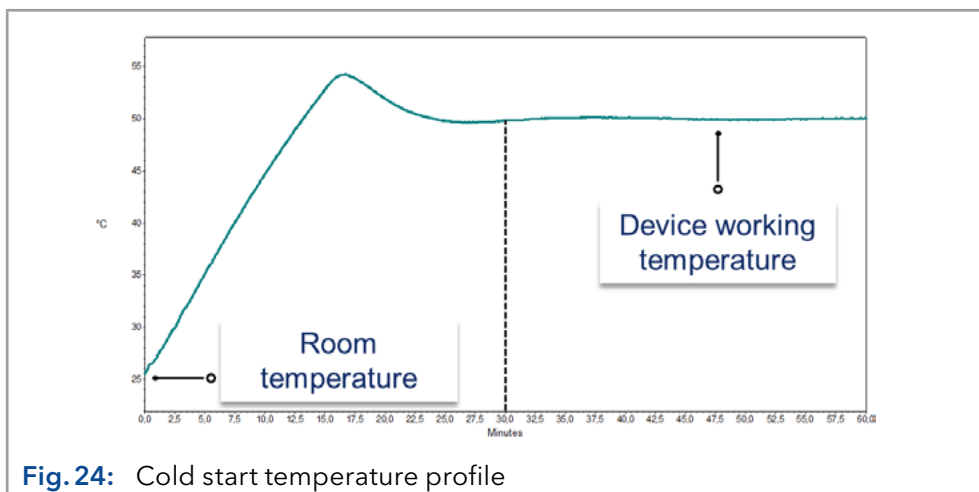
In this chapter, you find information on how to optimize your detector.

### 6.1 General

- Performance**
- The performance of the detector is largely dependent on the performance of the HPLC system.
  - Noise can be related to pump stability, the flow cell cleanliness, lamp quality, mobile phase composition and other factors.
  - Drift is usually related to long-term changes in the environment, such as detector warm-up or fluctuations in temperature and mobile phase composition.

**Location** In order to ensure thermo stability and to prevent drift effects, note the aspects listed in the section “4.2 Ambient conditions” on page 13.

**Warmup time** The recommended warm-up time for the detectors is 30 minutes. This recommendation is applicable for the detector on as well as for the lamp/s.



### 6.2 Selecting the flow cell

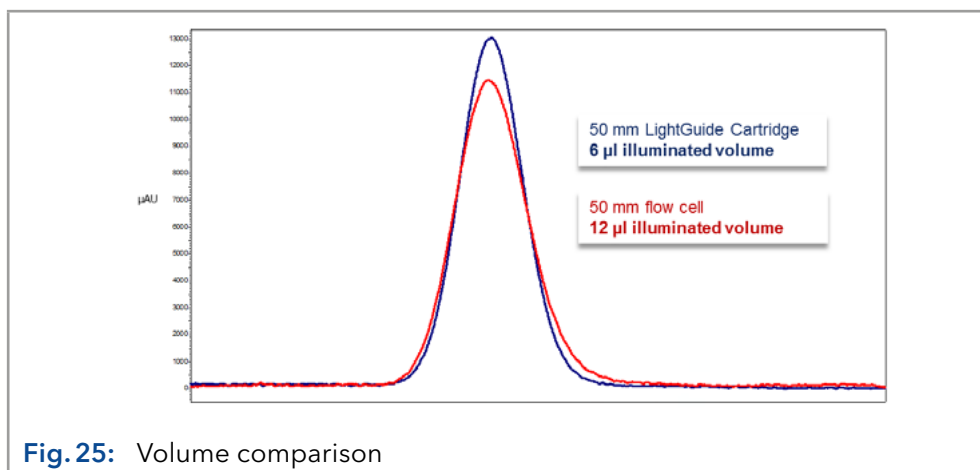
Several different flow cells are available for the detector. Note that the detector is shipped with a test cell. A flow cell has to be ordered separately.

Signal sensitivity, peak broadening and response can all be affected by the choice of flow cell. Volume, path length as well as wetted parts, required pressure range, flow cell connection, and remote operation are further factors that need considering when selecting a flow cell.

**Flow cell volume** Depending on your instrument setup, column and sample(s), one flow cell volume may be more appropriate than another. If the volume is too large, two adjacent peaks may get mixed in the cell.

If the volume is too small, the noise may be higher and the signal may be too small due to less light reaching the photodiodes.

Ideal flow cell volume therefore is a compromise between peak broadening and sensitivity (see Fig. 25).



A good rule of thumb is that the flow cell volume should not be more than 1/3 of the peak volume of your separated sample. To determine the volume of your peaks, take the peak width as reported in the integration results, multiply it by the flow rate and divide it by 3.

Cartridge flow cells with volumes of 2 μl, 6 μl and 10 μl are available for the detectors. Narrow-bore columns (~ 2.1 mm ID) are suitable for flow cells with smaller volumes. Columns with a larger inner diameter (~ 3,0 mm ID) are less affected by the volume of the flow cell.

The flow rate should also be taken into consideration. A lower flow rate increases the axial and longitudinal diffusion and adds to a broadened flow profile which may lead to a peak broadening.

**Path length** As described by the Beer-Lambert law, the path length of a flow cell affects the light intensity that is detected.

$$A = -\log T = \log\left(\frac{I}{I_0}\right) = \epsilon \times d \times c$$

A: measured absorption at a given wavelength

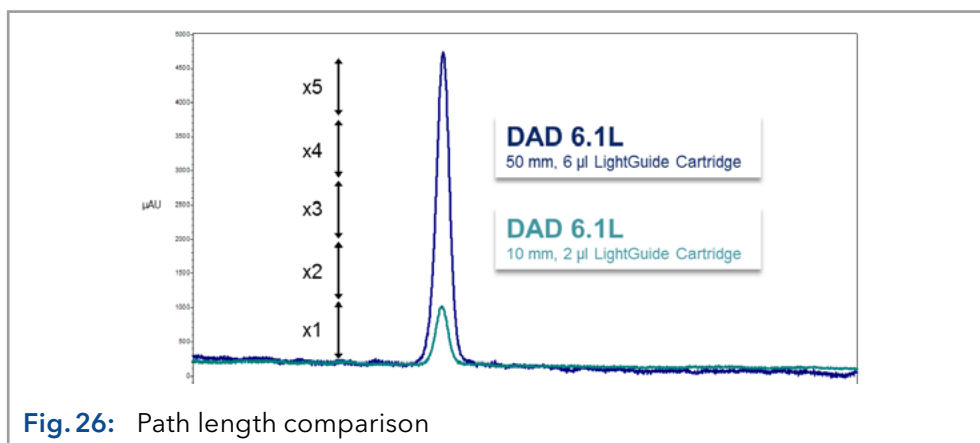
T: transmittance, defined as the quotient of the light intensity (**I**) after passing through the sample and the initial light intensity (**I<sub>0</sub>**) before passing through the sample

ε: molar absorptivity coefficient (wavelength and temperature dependent)

d: path length

c: analyte concentration (temperature-dependent)

For the same concentration, the peak height will be higher if the path length is longer. Path lengths of 3 mm, 10 mm, and 50 mm are available for the detectors. A longer path length, therefore, increases the sensitivity of a method (see Fig.26). The limit of detection is inversely proportional to the path length.



**Wetted parts** The wetted parts of the flow cell have to be chemically compatible with the solvents and sample you are working with (see chapter “14. Chemical compatibility of wetted materials” on page 71). Biocompatible flow cells (with titanium/metal-free) are available (see chapter “13. Reorders” on page 67).

**Pressure stability** The different flow cells can withstand various maximum pressures. The upper pressure limits of the flow cells are 30 bar, 50 bar, or 300 bar. The flow cell should not be subjected to the maximum pressure for a long period of time.

**Connection** Undesired effects, like the loss of resolution in the chromatogram, may be prevented by ensuring a correct connection to the flow cell and the removal of any dead volume.

**Remote operation (fiber optics)** If the flow cell has to be positioned outside of the detector (e.g. in an explosion-proof room, at higher temperatures such as in an oven, or in an environment with radioactive substances), the devices can be optionally equipped with fiber optic connectors. Remote flow cells are recommended for preparative applications (high flow rates), in order to protect sensitive optical components from potential leakages.

For detectors with fiber optic cables the light intensity does not depend just on the lamp and the cell but also on the quality / condition of the fiber optic cables, the quality of the connections, the length of the fiber optic cables, the number of bends and the bending radius.

Sensitivity is typically reduced to half that of an equivalent standard cell when working with standard length fiber optic cables (750 mm). Overall, sensitivity is inversely proportional to the length of the fiber optic cables.

Temperature changes around the cables may cause additional drift.

## 6.3 Selecting the wavelength

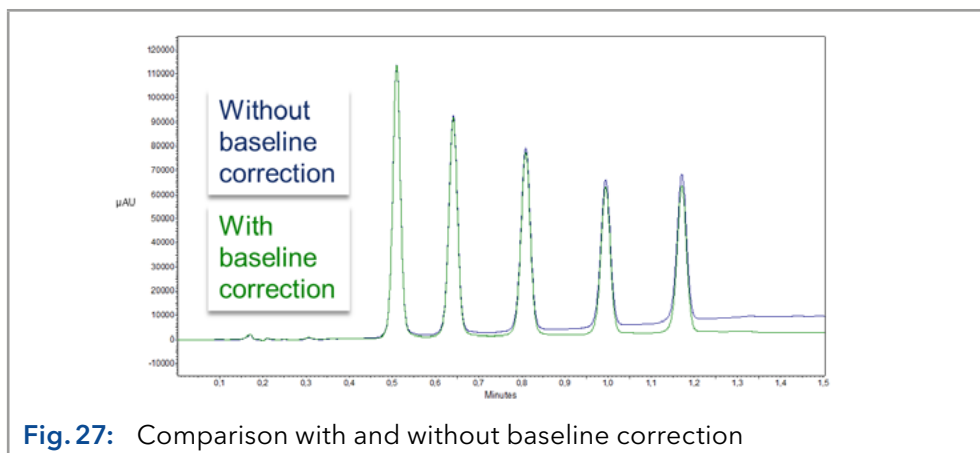
**Signal wavelength** Wavelength selection can influence the sensitivity, selectivity and linearity of a measurement. The measurement wavelength can be selected within the range from 190-1000 nm for the DAD 6.1L or 190-700 nm for the DAD 2.1L and MWD 2.1L in 1 nm steps. The best wavelength for a given measurement (signal wavelength) is that which gives the maximum absorption above the UV cutoff of the mobile phase. In cases where there are multiple components with different absorbance maxima, a compromise wavelength has to be chosen where all components absorb.

**Baseline correction / reference wavelength** In order to minimize baseline drift due to refractive index effects, a reference wavelength can be set in order to correct the baseline (see figure

22). The reference should be set in the same spectral region as the signal wavelength (UV or Vis) but at a wavelength at which the analyte has no absorbance.

### Default reference wavelength

By default, the reference wavelength 360 nm is activated (for channel 2). This is a suitable value for most applications.

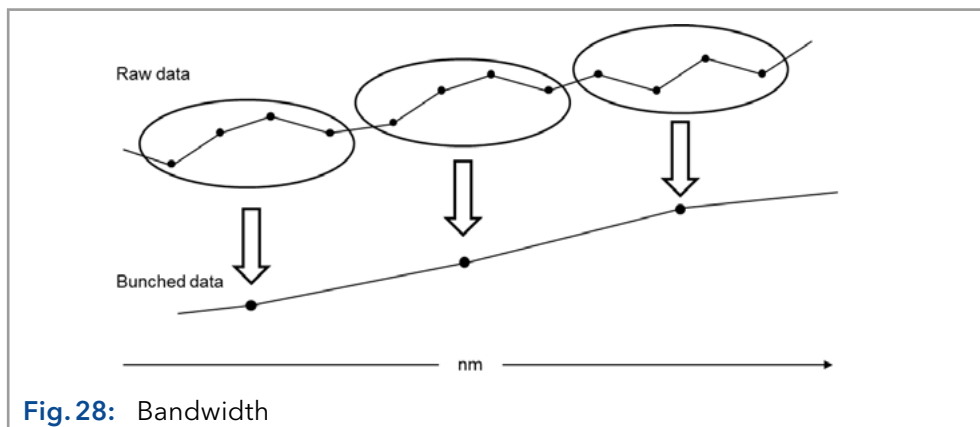


**Fig. 27:** Comparison with and without baseline correction

When selecting the signal and reference wavelengths, the respective bandwidths must also be selected (see the following section).

### 6.3.1 Bandwidth

The bandwidth defines the total number of wavelengths actually registered by the photodiode when a specific wavelength is set. For example, a wavelength set at 254 nm with a bandwidth of 4 nm results in average absorption of 252 - 256 nm.



**Fig. 28:** Bandwidth

The selection of bandwidth is a balance between sensitivity and selectivity. Narrow bandwidths increase selectivity, whereas broad bandwidths increase sensitivity.

### Default bandwidth

By default (see section "5.5 Default settings" on page 33), the bandwidth for the signal wavelength is set to 8 nm and for the reference wavelength the bandwidth is set to 30 nm.

## 6.4 Spectral range

When measuring with chromatography software, the spectral range selected for a given measurement influences the required disc space. The disc space is necessary to save generated data.

A narrow spectral range reduces disk space. The range, however, should be wide enough to ensure the detection of all components. Also, the spectral range always has to include the signal wavelength and the reference wavelength (when applicable).

## 6.5 Time constant & data rate

**Response time** The time constant influences the response time of the detector. The response time determines how quickly the detector responds to a change in signal. A good rule of thumb for selection of the time constant is that it should be no larger than  $\frac{1}{10}$  of the baseline peak width of the first peak of interest (in seconds). Increasing the time constant allows more averaging of the signal (also known as digital filtering) and results in less baseline noise. However, increasing the time constant too much may result in broad peaks, reduced peak heights and asymmetric peak shapes. Therefore, a compromise has to be found.

**Time constant** Using the time constant a signal smoothing can be achieved. The larger this value is set, the more the signal will be smoothed. In general, the best time constant is the reciprocal of the data rate (see table below). If increased sensitivity is desired, or if the baseline noise is interfering with integration, the time constant should be increased. If resolution is compromised, it should be decreased.

It is recommended to set the time constant and data rate in relation to peak width.

Peak width [min]	Time constant [s]	Data rate [Hz]
<0.003	0.01	100
>0.007	0.02	50
>0.017	0.05	20
>0.033	0.1	10
>0.067	0.2	5
>0.167	0.5	2
>0.333	1	1

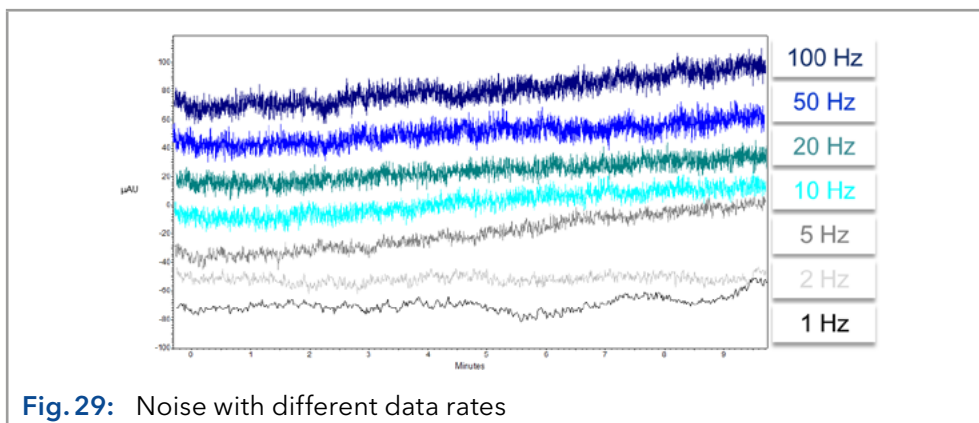
**Data rate** The data rate (or sampling rate) is the number of data points per second (Hz) at which the detector transmits data to the computer.

**Default data rate** The default data rate setting for the detectors is 1 Hz (see section "5.5 Default settings" on page 33). The maximum data rate (digital signal) is 100 Hz. Lower data rates store average data points. A 50 Hz data rate averages 2 points. A 10 Hz data rate averages 10 points. The analog data rate is fixed at 12.5 Hz.

**Optimizing the data rate** The optimal data rate depends on your application. Too few points across a peak (short data rate) decrease detail and compromise reproducibility. Too many points (high data rate) introduce noise into the system and the resulting files can become very large.

Some general considerations are listed below:

- Each peak should be defined by 20–30 data points. For chromatograms with co-eluting peaks or low signal-to-noise ratios, 40–50 data points per peak are recommended.
- If all peaks are relatively wide, select a slower data rate.
- If any peaks of interest are less than a few seconds, select a faster data rate.
- If the data rate is too slow, the start and end points of the peaks are not accurately determined. If the data rate is too fast, data files may occupy excessive disk space and post-run analyses may require more processing time.



## 6.6 Integration time

**Signal level** The integration time influences the intensity of the signal and therefore the sensitivity of the measurement. The larger the integration time, the higher the intensity of the signal until the maximum sensor counts are reached. The integration time is automatically calculated by the software before the start of a measurement. The calculations are in relation to the spectral range (see section “6.4 Spectral range” on page 40).

When a narrower spectral range is selected, the signal intensity will be increased. This increase is limited, however, by the data rate.

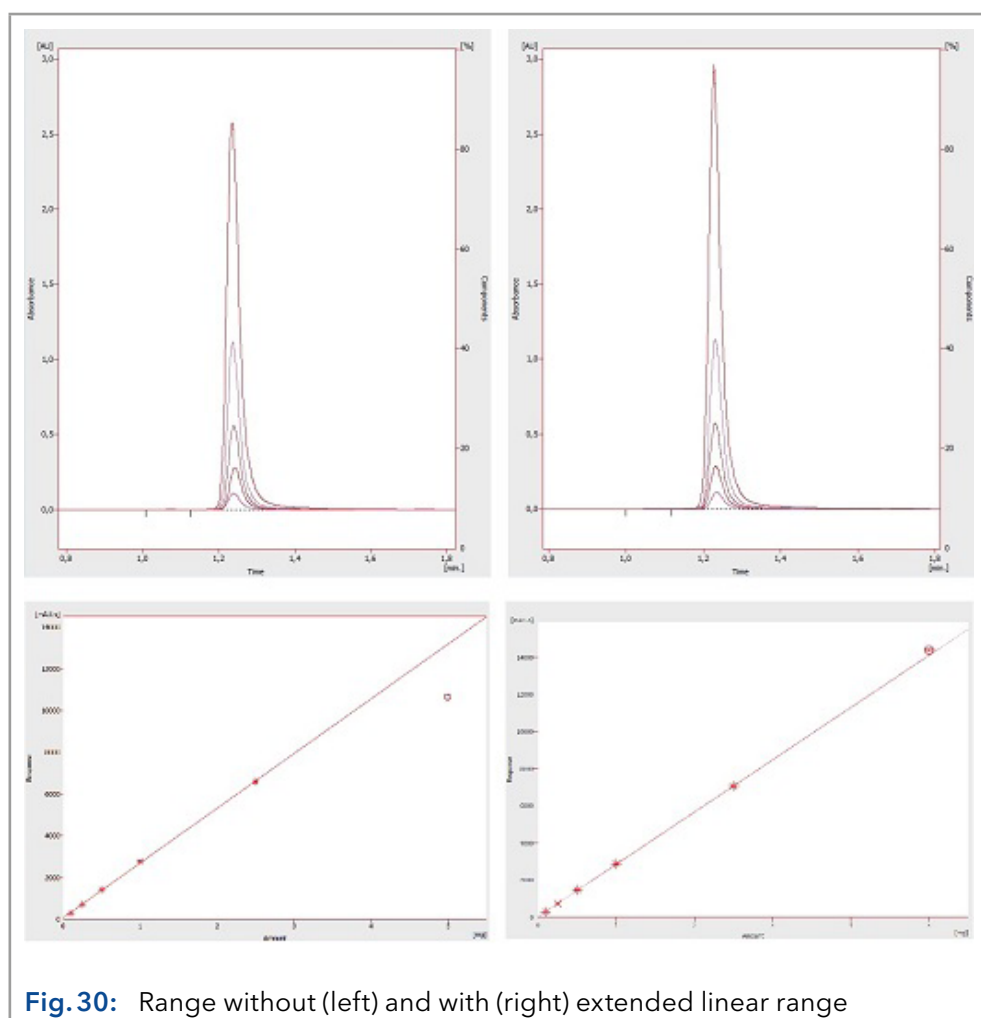
## 6.7 Subtraction of the baseline chromatogram

The baseline subtraction can eliminate the effects of drift that result from solvent, gradient, or flow programming. The baseline profile is subtracted from the measured chromatogram. This results in a mathematically reprocessed chromatogram with an ideally flat baseline.

### 6.7.1 Extended linear range

Upon activating the extended linear range option it is possible to broaden the linear range of the AZURA detector, through internal stray light correction. This option can be activated in the used software under advanced settings. You find further information in the respective software instructions.

The Extended Linear Range option is available for devices with firmware versions 01.23 (DAD 6.1L) and 01.10 (DAD 2.1L, MWD 2.1L) or higher.





## 7. Functionality tests



**Note:** Standard processes regarding IQ and OQ in single devices may be handled differently in individual cases.

### 7.1 Installation Qualification (IQ)

The customer may request the Installation Qualification, which is free of charge. In case of a request, the technical support of KNAUER or a provider authorized by KNAUER performs this functionality test during the installation.

The Installation Qualification is a standardized document that includes the following:

- confirmation of flawless condition at delivery
- check if the delivery is complete
- certification on the functionality of the device

You can either use the IQ document attached to this instruction manual or download a digital version from our website:



### 7.2 Operation Qualification (OQ)

The Operation Qualification includes an extensive functionality test according to KNAUER standard OQ documents. The Operation Qualification is a standardized document and free of charge. It is not part of the delivery. Please contact the technical support in case of a request.

The Operation Qualification includes the following:

- definition of customer requirements and acceptance terms
- documentation on device specifications
- device functionality check at installation site

**Test intervals** To make sure that the device operates within the specified range, you should test the device regularly. The test intervals depend on the usage of the device.

**Execution** The test can be carried out either by the technical support of KNAUER or by a provider authorized by KNAUER (for a fee). For further information visit our website:



## 8. Troubleshooting

First measures:

- Check all cables and fittings.
- Check if air has gotten into the supply lines.
- Check the device for leakages.

Further measures:

- Compare occurring errors with the list of possible errors (see below).
- Contact the Customer Support.

### 8.1 LAN

Go through the following steps, in case no connection between the computer and the devices can be established. Check after each step if the problem is solved. If the problem cannot be located, call the Technical Support.

1. Check the status of the LAN connection in the Windows task bar:



If no connection was established, test the following:

- Is the router switched on?
  - Is the patch cable connected correctly to the router and the computer?
2. Check the router settings:
    - Is the router set to DHCP server?
    - Is the IP address range sufficient for all the connected devices?
  3. Check all connections:
    - Are the patch cables connected to the LAN ports and not the WAN port?
    - Are all cable connections between devices and router correct?
    - Are the cables plugged in tightly?
  4. If the router is integrated into a company network, pull out the patch cable from the WAN port.
    - Can the devices communicate with the computer, even though the router is disconnected from the company network?
  5. Turn off all devices, router, and computer. First switch on the router and wait until it has successfully completed its self-test. Firstly, turn on the router and secondly turn on the devices and the computer.
    - Has this been successful?
  6. Replace the patch cable to the device with that no connection could be established.
    - Has this been successful?
  7. Make sure that the IP port of the device matches the port in the chromatography software.

## 8.2 Possible problems and solutions

Problem	Solution
Baseline drift	Maintain constant temperature conditions during the measurement.
Device cannot be switched on	Inspect the power cable to ensure that it is plugged into the power supply.
Device cannot be calibrated	<ol style="list-style-type: none"> <li>1. Insert the test cell.</li> <li>2. Inspect the calibration with a weak absorbing eluent.</li> </ol>
Baseline noise	<ol style="list-style-type: none"> <li>1. Inspect the flow-cell assembly.</li> <li>2. Exchange the defective flow cell.</li> <li>3. Inspect the service life of the lamp on the display.</li> <li>4. Reduce the air in the flow cell by using a degasser.</li> </ol>
The relationship of the signal to the light path reference is very low	<ol style="list-style-type: none"> <li>1. Flush the flow cell.</li> <li>2. Replace the lamps</li> </ol>
Low UV light	Clean fiber optic ends with alcohol and cotton bud.

### Further measures

- Install the maintenance software (Service Tool).
- Save device information and send to manufacturer.
- Inform the Technical Support of KNAUER.

## 8.3 System messages

If other system messages are displayed besides those listed below, please turn the device off and then back on. Inform the Technical Support of the manufacturer in case the system message repeats itself.

The system messages are in alphabetical order:

	System message	Problem and solution
C	"Cannot initialize LAN"	Check cables and connections in local area network.
	"Cannot proceed: D2 lamp heating"	Manual validation is not possible while lamp is heating up. Wait until deuterium lamp has initialized and continue afterwards.
	"Cannot proceed: D2 lamp off"	Manual validation is not possible while lamp is switched off. Switch the lamp on. In case the error shows again, restart the device. In case no improvement shows, replace the lamp.
	"Cannot proceed: Low light"	Validation failed because of exceeded integration time. The operating time of the lamp has been exceeded. Replace the deuterium lamp.  Flow cell is dirty. Clean the flow cell.  Error state of the optical system. Inform the Technical Support of KNAUER.
	"Communication timeout"	Timeout: Connecting error RS-232 (5 s), leak sensor (0,5 s) or any hardware component (lamp power connection, EPROM, I2C with GUI).
D	"D2 lamp failed"	Manual validation is not possible without deuterium lamp.
	"D2 lamp operation failed"	Restart the device. If the error occurs again, replace the lamp.
	"D2 lamp does not start"	Switch off lamp and turn on again. If the system message repeats, inform the Technical Support of KNAUER. The lamp unit has to be replaced.  No lamp ignition when starting the device or the manual validation.
	"Data acquisition active"	No entries are possible. First stop acquiring measurement data, afterwards you can make a new entry.
E	"Error input activated"	External error, outside the device: Check the external devices and cable connections.  Check the system to locate and remove the error.
H	"HAL lamp does not start" (DAD 6.1L)	Switch the lamp on. In case the error shows again, restart the device.  In case no improvement shows, replace the lamp.

	<b>System message</b>	<b>Problem and solution</b>
<b>I</b>	"Instrument busy"	3D data is being collected while scanning, leak sensor or cover are processing earlier inputs. Wait until the device has completed the process.
	"Instrument in standalone mode"	Command can not be executed in local operation (only in remote operation)
	"Instrument in standby mode"	Command not allowed during standby mode.
	"Instrument not validated"	Data acquisition or simple scans can not be executed, if the system has not been validated.
	"Instrument remote controlled"	This entry is not executable. Quit software.
<b>L</b>	"Lamp cover open"	The lamp cover was mounted incorrectly or the micro switch is malfunctioning. Mount the lamp cover. If the system message repeats, inform the Technical Support of KNAUER.
	"Lamp not installed"	GLP data can not be read and lamp operation can not be executed, as the lamp (D <sub>2</sub> or halogen) has not been installed.
	"Lamps off"	Command can not be executed, as the lamps are being switched off.
	"Lamp supply is not available"	Power supply of lamp has not been installed or does not react.
	"Lamp supply temperature limit exceeded"	The upper temperature limit for power supply of lamp was exceeded.
	"Lamp unit temperature limit exceeded"	The upper temperature limit for lamp unit was exceeded.
	"Lamp unit temperature sensor failed"	Temperature sensor of lamp unit was not found or does not react.
	"Leak sensor failed"	Switch the device off and then on. If the leak sensor is still not present, contact the Technical Support of the manufacturer. Leak sensor was not found or does not react.
	"Leak was detected"	Switch off the device. Remove the leak and start the device afterwards.
<b>N</b>	"No D2 lamp detected"	Check if the deuterium lamp was installed correctly.
<b>R</b>	"Recommended D2 lamp life exceeded"	The recommended operating time of the deuterium lamp of 2000 hours was exceeded. Replace the lamp.
	"Recommended HAL lamp life exceeded"	The recommended operating time of the halogen lamp of 1000 hours was exceeded. Replace the lamp.

	<b>System message</b>	<b>Problem and solution</b>
<b>S</b>	"Shutter position failed"	Malfunction of cover motor
	"Spectrum buffer overflow"	The internal 3D data buffer was used up because of a LAN connection error.
<b>T</b>	"Spectrum output busy or not ready"	3D data acquisition can not be started. Wait until data transfer is finished and continue afterwards.
	"Temperature control failed"	The upper temperature limit of the lamp unit was exceeded.
<b>W</b>	"WL/BW out of spectral range"	Selected path length and bandwidth exceed the spectral range. Expand the selected spectral range or the selected path length/bandwidth.
	"WL validation failed"	Wavelength accuracy test failed. Restart the validation. Holmium oxide and/or H <sub>α</sub> , H <sub>β</sub> lines do not meet the specifications.  If the system message repeats, inform the Technical Support of KNAUER.

## 9. Maintenance and care

### 9.1 General

Maintenance of a HPLC instrument is critical to the success of analyses and the reproducibility of results. If you require a maintenance task which is not described here, contact your dealer or the Customer Support.

All wetted components of a device, e. g. flow cells of detectors, have to be flushed with isopropanol first and water second before being maintained, disassembled or disposed.

#### 9.1.1 Maintenance tasks performed by the user

##### **DANGER**

###### **Electric shock**

Danger of electric shock from voltage-carrying parts inside the device. The housing serves as a protective cover against voltages inside the device.

- Switch the device off before opening the device.
  - Pull the power plug.
- 

##### **WARNING**

###### **Eye injury**

Irritation of retina through UV light. High-energy UV light can leak out from the flow cell or the fiber optic connectors.

- Switch off the detector or the lamps.
- 

##### **NOTICE**

###### **Electronic defect**

Performing maintenance tasks on a switched on device can cause damage to the device.

- Switch off the device.
  - Pull the power plug.
- 

Users may perform the following maintenance tasks themselves:

- Regularly check the operating hours of the lamp (see section 9.1.3).
- Inspect the installation of the flow cell. (see section 4.5)
- Replace the flow cell (see section 9.4).
- Replace the lamp (see section 9.5).

Proper maintenance of your HPLC device will ensure successful analyses and reproducible results.

You find the order numbers for the desired spare parts at the end of these instructions (see chapter "13. Reorders" on page 67).

## 9.1.2 Maintenance contract

Opening the device or removing housing parts may only be performed by KNAUER or a company authorized by KNAUER and is covered by a separate maintenance contract.

## 9.1.3 Maintenance intervals

**Operating hours** Using Mobile Control or software, you can read out the operating hours of the detector. You find a detailed description on how to read out GLP data in chapter "5.6 GLP" on page 34.

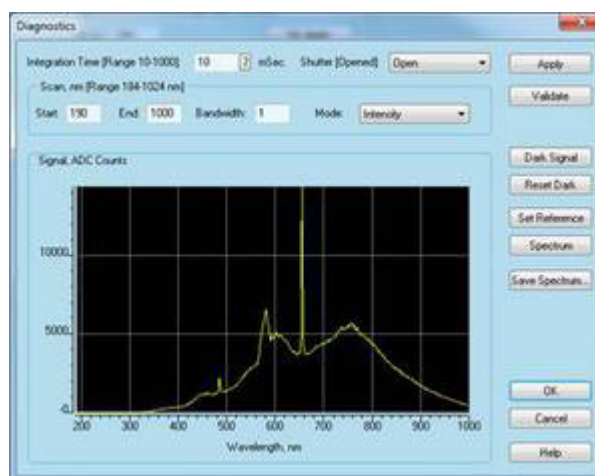
Operating hours	Measures
1 000	<ul style="list-style-type: none"> <li>Replace halogen lamp (DAD 6.1L).</li> </ul>
2 000	<ul style="list-style-type: none"> <li>Replace deuterium lamp.</li> </ul>
6 000	<ul style="list-style-type: none"> <li>Replace flow cell.</li> <li>Replace fiber optic cables.</li> </ul>

## 9.2 Cleaning and caring for the device

### 9.2.1 Handling the flow cell cartridge

An important aspect in handling your flow cell cartridge, is that you should not touch the fiber optic ends with your fingers. Your finger may leave a thin fat layer on the fiber optic ends, which drastically impairs the flow cell's and detector's performance (see section "8.2 Possible problems and solutions" on page 45).

To diagnose this issue, we recommend generating an intensity spectrum (via your chromatography software under Diagnostics). Dirty fiber optic ends result in little or no UV light (see below).



**Fig. 31:** Intensity spectrum



## 9.2.2 Surfaces

### NOTICE

#### Device defect

Intruding liquids can cause damage to the device.

- Place solvent bottles next to the device or in a solvent tray.
- Moisten the cleaning cloth only slightly.

#### Display

All smooth surfaces of the device can be cleaned with a mild, commercially available cleaning solution, or with isopropanol.

Display screens can be cleaned with isopropanol and should be wiped dry with a soft, lint-free cloth.

## 9.3 Cleaning the flow cell

Increased noise of the baseline and reduced sensitivity can be a result of a dirty flow cell. Often it is sufficient to rinse the flow cell to restore optimal sensitivity.



**Hinweis:** In the case of using acetonitrile or mixtures containing acetonitrile as mobile phase in combination with the LightGuide flow cells it is necessary to clean the flow cell in regular intervals for maintaining the performance of the cell. For this purpose flush the flow cell every 24 h for at least 1 h with pure methanol at 1 ml/min. Please remove your installed column for this flush step.

### 9.3.1 Basic cleaning

The following solvents are recommended for rinsing:

- Dilute HCl (1 mol/l)
- 1 mol/l NaOH aq.
- Ethanol
- Acetone

#### Tools

Syringe

### NOTICE

#### Performance decrease

For the drying step, oil drops from compressed air can contaminate the flow cell which may result in performance decrease.

- Do not use compressed air for drying.

#### Process

##### Steps

1. Fill the syringe with eluent.
2. Inject it into the inlet of the flow cell and allow it to act for 5 minutes.
3. Repeatedly flush with syringe and water.
4. Remove the flow cell from the detector and use a nitrogen stream to dry it.

#### Next step

Check if the baseline noise has disappeared.

## 9.3.2 Advanced cleaning

This section describes a cleaning procedure for aggressive cleaning of LightGuide flow cells.

### Preparation of chemicals

All chemical reagents should be of at least ACS-Grade, preferably HPLC-Grade. This procedure involves the use of caustic and flammable reagents (see "2. Basic safety instructions" on page 3).

### Cleaning solutions

**#1:** 0.5 M Potassium Hydroxide in 100 % Ethanol (briefly, 7.013 g KOH in 250 ml EtOH). After thorough mixing, the solution should be filtered through a 20 µm pore size filter.

**#2:** 100 % Methanol

**#3:** Ultrapure water, Type I per ASTM D1193-99 or equivalent.



**Note:** Grade 1 ultrapure water per ISO 3696 differs significantly from the above classification.

### Prerequisites

- The cleaning solutions #1, #2 and #3 are readily prepared.
- The flow cell is installed in a detector.

### Tools

2 syringes with appropriate volumes (about 10 ml) or a peristaltic pump



**Note:** It is imperative that Solution #2 immediately follow Solution #1 to remove residue remaining on the optical components. Failure to do so will result in poor flow cell performance.



**Note:** It is recommended the peristaltic pump is configured to "pull" through the cell to avoid possible contamination from degraded peristaltic pump tubing. To lessen the time required for this cleaning method, large bubbles of air can be introduced into the flow cell alternately with the cleaning solutions. This method uses a laminar flow profile and radial diffusion to effectively "scrub" the inside of the flow cell.



**Note:** Observe the extent of performance improvement in the Diagnostics window throughout the entire process.

### Cleaning with pump

#### Process

1. Flow each cleaning solution through the flow cell in numerical order.
2. Cycle each solution for approximately 3-4 minutes, with a bolus of air introduced between each solution. The flow direction can be reversed between cycles to ensure thorough cleaning.
3. Repeat the procedure until there is no noticeable improvement in sample cell performance.
4. Continue with the "Final Rinsing" below.

**Cleaning with syringes****Process**

1. Disconnect the capillaries.
2. Connect the syringes to the liquid ports of the flow cell.
3. Introduce each cleaning solution into the flow cell.
4. Flush each cleaning solution back and forth between the syringes 10-12 times.
5. Repeat the procedure until there is no noticeable improvement in flow cell performance.
6. Continue with the "Final Rinsing" below.

**Final rinsing****Process**

1. Identify the point where subsequent cleaning cycles no longer improve the performance of the flow cell.
2. Flush the unit with ultrapure water for a period of at least 15 minutes to ensure all cleaning solutions have been completely removed and there are no persistent residues that might affect flow cell performance or stability.

**Result** The flow cell performance and stability improve noticeably.

**Next step** Flush the flow cell with the solution that is going to be used in your next application. Afterwards you can start your application

### 9.3.3 Cleaning protocol for KNAUER LightGuide Flow cells

**Preliminary note** KNAUER recommends to carry out this cleaning procedure at regular intervals (every two weeks) when using acetonitrile-containing eluents in order to extend the life of the flow cells.

- Materials**
- Potassium hydroxide (pellets)
  - Hydrogen peroxide solution (30%)
  - Water (MilliQ)
  - A syringe with Luer Lock adapter for UNF 10/32 threading (Volume: at least 5 ml)
  - Waste tube
  - Hole plug

- Production of the cleaning solution**
- 5.7 g of potassium hydroxide are carefully dissolved while stirring in 10 ml of water under heat generation.
  - The solution is added slowly with 6 ml of 30% hydrogen peroxide solution while stirring (heat and gas evolution).
  - The resulting solution is finally mixed with 10 ml of water and used directly for cleaning.
  - The cleaning solution should always be freshly prepared for cleaning to ensure an optimum cleaning performance.

**Cleaning****Process**

1. For cleaning, the flow cell may need to be rinsed with water beforehand. The flow cell must not contain any residues of organic solvents!
2. A syringe with Luer Lock adapter is filled with at least 5 ml of the cleaning solution and connected to the inlet port of the flow cell.
3. The outlet port of the flow cell is connected to a waste tube and connected to a waste container.
4. Slowly and carefully flush the flow cell with the cleaning solution.
5. Remove the waste tube from the flow cell and close the port with a hole plug.
6. Remove the syringe from the inlet port and close it with a hole plug as well.
7. Leave the cleaning solution in the flow cell for at least 2 hours. For a more extensive cleaning, it is recommended to let the cleaning solution work overnight for at least 12 hours.
8. After the exposure time, remove the hole plugs, fill a Luer Lock syringe with at least 5 ml of water and connect it to the inlet port. Install the waste tube again at the outlet port.
9. Slowly and carefully flush the flow cell with water. Then install the flow cell in the system and flush with water for 15 minutes at a flow of 1 ml/min.
10. Check the light intensity via the diagnostic function. The intensity at 220 nm should be at least 3 500 ADC counts.
11. If necessary repeat the cleaning steps 2 to 9 and check the light intensity at 220 nm again.

## 9.4 Replacing the flow cell

UV light will cause the flow cells to become blind with time (solarization), making them no longer suitable for use. The manufacturer recommends replacing the flow cell after about 6000 operating hours.

**Prerequisites**

- The capillaries are disconnected.
- The device is switched off.

**⚠ WARNING****Eye injury**

Irritation of retina through UV light. High-energy UV light can leak out from the flow cell or the fiber optic connectors.

→ Switch off the detector or the lamps.

**NOTICE****Performance decrease**

Any components in the light path like fiber optic ends become contaminated when touched with fingers.

- Avoid touching the ends without gloves.
- Use alcohol and a cotton bud for cleaning.

**Steps**

1. Press the release lever ① down.
2. The flow cell is being released and can be pulled out.
3. Push in the new flow cell until it locks into place.

**Figure**

**Fig. 32** Releasing the flow cell

**Next step** Connect the capillaries.

## 9.5 Replacing the lamps

Replace the lamp if it malfunctions or its intensity is low.

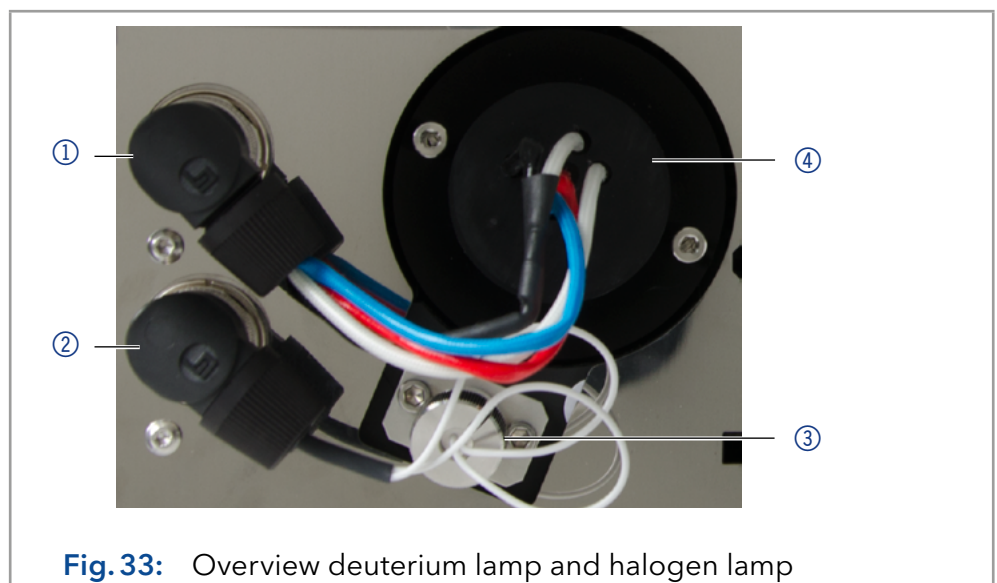


**Note:** After installing a new deuterium lamp into the detector, ensure to allow the lamp a running-in time of approximately 24 hours.

Device	Lamp	Recommended operating time
DAD 6.1L, DAD 2.1L, MWD 2.1L	Deuterium	2 000 h
DAD 6.1L	Halogen	1 000 h

**Legend**

- ① Deuterium lamp connector
- ② Halogen lamp connector (DAD 6.1L)
- ③ Halogen lamp (DAD 6.1L).
- ④ Deuterium lamp



**Fig. 33:** Overview deuterium lamp and halogen lamp

## 9.5.1 Removing the deuterium or halogen lamp

- Prerequisites**
- The device is switched off.
  - The lamp has cooled down.

- Tools**
- Allen screwdriver, 2.5 mm
  - Phillips screwdriver PH1



**Note:** If the device is still in operation, the integrated security switch turns off the lamp automatically on opening the lamp cover. An error message is displayed. Additionally, the red LED lights up and the center LED does not light.

### DANGER

#### Electric shock

High voltages inside the detector pose a life threatening risk.

- Disconnect the power supply before change the lamps.
- Check the status of the lamps in the software and on the LEDs.

### WARNING

#### Burns

Risk of burns from hot lamp. The lamp must cool down before replacement and cleaning.

- Turn off the lamp and leave the device on for at least 15 minutes to allow the lamp to cool down by the fan.
- Then switch off the device and unplug the power cable.

### Process

#### Step

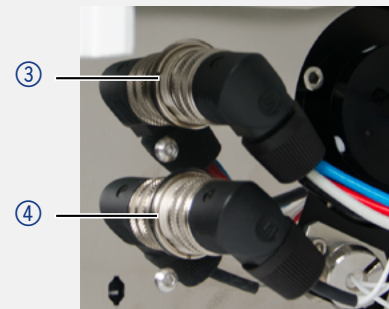
1. Loosen the screws ① and ② of the lamp cover.
2. Remove the lamp cover.

#### Figure

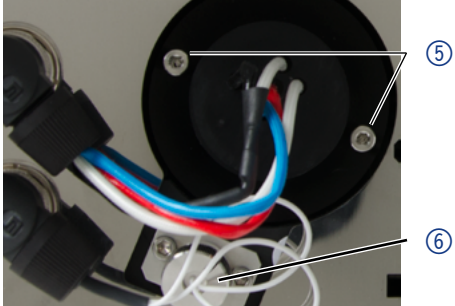


**Fig. 34** Lamp cover

3. Loosen the lock ring ③ or ④ of the lamp plug and pull out the plug.



**Fig. 35** Lock ring of lamp plug

Process	Step	Figure
	<ol style="list-style-type: none"> <li>In order to replace the deuterium lamp loosen the 2 screws ⑤ with the screwdriver and remove the lamp.</li> <li>In order to replace the halogen lamp loosen the lamp housing ⑥ and remove the lamp completely.</li> </ol>	

**Fig.36** Screws on the lamp socket

**Next step** Insert a new lamp.

## 9.5.2 Installing the deuterium or halogen lamp

Removing the lamp cover switches off the device.

- Prerequisites**
- The device is switched off.
  - The lamp cover is removed.
  - The old lamp is removed.



**Tools** Allen screwdriver, 2.5 mm

### NOTICE

#### Performance decrease

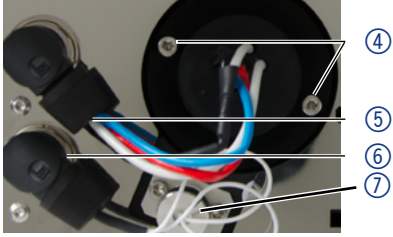

Damage to the lamp and inaccurate measuring results due to residue possible.

- Do not touch the glass body with your hands.
- Wear gloves.
- Use a clean, soft cloth for cleaning.

Process	Step	Figure
	<ol style="list-style-type: none"> <li>Hold the lamp at the lamp socket and guide the glass body into the lamp pod ①.</li> <li>The bolt ② of the deuterium lamp sits in a notch in the lamp socket.</li> </ol>	
	<ol style="list-style-type: none"> <li>Insert the halogen lamp ③ into the lamp pod at a slight angle.</li> </ol>	

**Fig.37** Lamp pod deuterium lamp

**Fig.38** Lamp pod halogen lamp

Process	Step	Figure
	<ol style="list-style-type: none"> <li>Install the deuterium lamp by tightening the two screws ④ using the screwdriver.</li> <li>In order to install the halogen lamp insert the lamp housing ⑦ into the opening and tighten it again.</li> <li>Connect the plug ⑤ or ⑥ and tighten the lock ring.</li> </ol>	 <p><b>Fig.39</b> Installing the deuterium lamp</p>
	<ol style="list-style-type: none"> <li>Attach the lamp cover and fix it with the screws ⑧ and ⑨.</li> </ol>	 <p><b>Fig.40</b> Lamp cover</p>

**Next step** Bring the device into operation.



**Note:** You can clean the lamp thoroughly with a lint free cloth and isopropanol.

## 9.6 Checking the fittings

Check if all fittings are tight. In case you find fittings that are not tight, tighten them up.

Capillary Screw Fittings	Torque
Stainless-steel fittings	5 Nm
PEEK fittings	0.5 Nm

## 9.7 Removing a leak

**Prerequisites** If the leak tray is filled with liquid, the leak has to be removed.  
**Auxiliary material** Cloth for drying the leak sensor

### Process

- Remove the leak.
- Dry the leak tray with the cloth.
- Confirm the error message via Mobile Control, the software or the standby switch (without software control).

**Next step** Bring the device into operation.



## 9.8 Decommissioning

The detector is designed for the use of different solvents. In case the detector has not been used for several weeks, solvent residues may cause damage. We, therefore, recommend to:

- Flush the flow cell and the capillaries.
- Completely remove used solvents.
- Fill the flow cell and the capillaries with isopropanol.

Before storage (see 10 on page 60), close the open connectors of the flow cell with hole plugs.

<b>Prerequisites</b>	The detector has been flushed.
<b>Auxiliary material</b>	Hole plugs and/or cap fittings

### Process

#### Steps

1. Unscrew the eluent supply lines and close the open connectors with hole plugs.
2. Disconnect the detector from the system and close the open connector of the flow cell with a hole plug.

<b>Next step</b>	Select a storage location according to the requirements (see chapter "12. Technical data" on page 62).
------------------	--

# 10. Transport and storage

Regarding the following information, carefully prepare the device for transport or storage.

## 10.1 Packing the device

- Original packaging: Ideally you should use the original transport packaging.
- Lifting: Grab the device around the center of both sides and lift it into the packaging. Do not hold onto front cover or leak tray, as these parts are loosely attached to the device.

## 10.2 Transporting the device

- Documents: If you want to return your device to KNAUER for repairs, enclose the "[Service request form and decontamination report](#)" which can be downloaded from our website.
- Device data: For a secure transport, note the weight and dimensions of the device (see chapter "12. Technical data" on page 62).

## 10.3 Storing the device

- Flushing solution: Pay attention that all hoses and capillaries have been emptied or filled with flushing solution (e. g. isopropanol) before storage. To prevent algae formation, do not use pure water.
- Seals: Close all inputs and outputs with cap fittings.
- Ambient conditions: The device can be stored under ambient conditions which are listed in the Technical Data section (see chapter "12. Technical data" on page 62).

---

# 11. Disposal

Hand in old devices or disassembled old components at a certified waste facility, where they will be disposed of properly.

## 11.1 AVV-Marking Germany

According to the German "Abfallverzeichnisverordnung" (AVV) (January, 2001), old devices manufactured by KNAUER are marked as waste electrical and electronic equipment: 160214.

## 11.2 WEEE registration number

KNAUER as a company is registered by the WEEE number DE 34642789 in the German "Elektroaltgeräteregister" (EAR). The number classifies to category 8 and 9, which, among others, comprises laboratory equipment.

All distributors and importers are responsible for the disposal of old devices, as defined by the WEEE directive. End-users can send their old devices manufactured by KNAUER back to the distributor, the importer, or the company free of charge, but would be charged for the disposal.

## 11.3 Eluents and other operating materials

All eluents and other operating materials must be collected separately and disposed of properly.

All wetter components of a device, e. g. flow cells of detectors or pump heads and pressure sensors for pumps, have to be flushed with isopropanol first and water afterwards before being maintained, disassembled or disposed.

## 12. Technical data

### 12.1 DAD 6.1L

Detection	
Detector type	Diode array detector
Number of diodes	1024
Pixel pitch	0.8 nm/diode
Detection channels	8 (digital), 4 (analog)
Light source	High brightness deuterium (D <sub>2</sub> ) lamp and halogen lamp with integrated GLP chip
Wavelength range	190 - 1000 nm
Spectral bandwidth	< 3.5 nm at H <sub>α</sub> line (FWHM) <b>Note:</b> digital bandwidth 1 - 32 nm
Wavelength accuracy	± 1 nm
Wavelength repeatability	± 0.1 nm
Wavelength verification	Internal holmium filter and deuterium lines
Noise	± 3.5 μAU at 254 nm
Drift	300 μAU/h at 254 nm
Linearity	> 2.0 AU at 274 nm, typically 2.5 AU
Time constants	0.00 / 0.01 / 0.02 / 0.05 / 0.1 / 0.2 / 0.5 / 1.0 / 2.0 / 5.0 / 10.0 s
Integration time	Automatic (5 - 1 000 ms)
Communication	
Max. data rate	100 Hz (LAN), 12.5 Hz (analog)
Interfaces	LAN (RJ-45), RS-232 (SUB-D 9, service only), multi-pin connector, 4 x analog (RCA cinch connector)
Control	Mobile Control, software, event control, analog, terminal protocol
Inputs	Error (IN), Start (IN), Autozero, Output Event 1-2 (Output TTL, OC, Relay)
Outputs	Error (OUT), +5 V, Valve +24 V, Valve (OUT), Events 1 - 2 (Relay and TTL compatible, respectively)
Analog output	4 x 0-5 V scalable, 20 bit, offset adjustable

Technical Parameters	
GLP	Detailed report including lamp recognition, operating hours, lamp operating hours, number of lamp ignitions
Display	Mobile Control (optional)
General	
Power supply	100-240 V, 50-60 Hz, 75 W
Dimensions	361 x 158 x 523 mm (W x H x D)
Weight	13.8 kg
Leak sensor	yes
Area of use	For indoor use only
Line voltage fluctuations do not exceed $\pm 10\%$ of normal voltage.	
Overtoltage category II:	Energy consumers are supplied by a fixed device.
Permitted pollution degree	2
Temperature range	4-40 °C (39.2-104 °F)
Air humidity	below 90 %, non-condensing
Operating height	max. 2000 Meters above sea level

Permitted operating environment

## 12.2 DAD 2.1L

Detection	
Detector type	Diode array detector
Number of diodes	256
Pixel pitch	2 nm/diode
Detection channels	8 (digital), 4 (analog)
Light source	Deuterium (D <sub>2</sub> ) lamp with integrated GLP chip
Wavelength range	190-700 nm
Spectral bandwidth	< 8 nm at H <sub>α</sub> line (FWHM) <b>Note:</b> digital bandwidth 1-32 nm
Wavelength accuracy	$\pm 1$ nm
Wavelength repeatability	$\pm 0.1$ nm
Wavelength verification	Internal holmium filter and deuterium lines
Noise	$\pm 5$ $\mu$ AU at 254 nm
Drift	400 $\mu$ AU/h at 254 nm

Linearity	> 1.6 AU at 274 nm, typically 2.0 AU
Time constants	0.00 / 0.01 / 0.02 / 0.05 / 0.1 / 0.2 / 0.5 / 1.0 / 2.0 / 5.0 / 10.0 s
Integration time	Automatic (5 - 1 000 ms)

### Communication

Max. data rate	100 Hz (LAN), 12.5 Hz (analog)
Interfaces	LAN (RJ-45), RS-232 (SUB-D 9, service only), multi-pin connector, 4 x analog (RCA cinch connector)
Control	Mobile Control, software, event control, analog, terminal protocol
Inputs	Error (IN), Start (IN), Autozero, Event 1-2 (TTL, OC, Relay)
Outputs	Error (OUT), +5 V, Valve +24 V, Valve (OUT), Start (OUT), Events 1 - 2 (Relay and TTL compatible, respectively)
Analog output	4 x 0-5 V scalable, 20 bit, offset adjustable

### Technical Parameters

GLP	Detailed report including lamp recognition, operating hours, lamp operating hours, number of lamp ignitions
Display	Mobile Control (optional)

### General

Power supply	100-240 V, 50-60 Hz, 75 W
Dimensions	361 x 158 x 523 mm (W x H x D)
Weight	12.2 kg
Leak sensor	yes
Area of use	For indoor use only
Line voltage fluctuations do not exceed $\pm 10\%$ of normal voltage.	
Oversvoltage category II:	Energy consumers are supplied by a fixed device.
Permitted pollution degree	2
Temperature range	4-40 °C (39.2-104 °F)
Air humidity	below 90 %, non-condensing
Operating height	max. 2 000 Meters above sea level

**Permitted operating environment**

## 12.3 MWD 2.1L

Detection	
Detector type	Multiwavelength detector
Detection channels	8 (digital), 4 (analog)
Light source	Deuterium (D <sub>2</sub> ) lamp with integrated GLP chip
Wavelength range	190 - 700 nm
Spectral bandwidth	< 8 nm at H <sub>α</sub> line (FWHM) <b>Note:</b> digital bandwidth 1-32 nm
Wavelength accuracy	± 1 nm
Wavelength repeatability	± 0.1 nm
Wavelength verification	Internal holmium filter and deuterium lines
Noise	± 5 μAU at 254 nm
Drift	400 μAU/h at 254 nm
Linearity	> 1.6 AU at 274 nm, typically 2.0 AU
Time constants	0.00 / 0.01 / 0.02 / 0.05 / 0.1 / 0.2 / 0.5 / 1.0 / 2.0 / 5.0 / 10.0 s
Integration time	Automatic (5 - 1 000 ms)
Communication	
Max. data rate	100 Hz (LAN), 12.5 Hz (analog)
Interfaces	LAN (RJ-45), RS-232 (SUB-D 9, service only), multi-pin connector, 4 x analog (RCA cinch connector)
Control	Mobile Control, software, event control, analog, terminal protocol
Inputs	Error (IN), Start (IN), Autozero, Event 1-2 (TTL, OC, Relay)
Outputs	Error (OUT), +5 V, Valve +24 V, Valve (OUT), Start (OUT), Events 1 - 2 (Relay and TTL compatible, respectively)
Analog output	4 x 0-5 V scalable, 20 bit, offset adjustable
Technical Parameters	
GLP	Detailed report including lamp recognition, operating hours, lamp operating hours, number of lamp ignitions
Display	Mobile Control (optional)

<b>General</b>	
Power supply	100-240 V, 50-60 Hz, 75 W
Dimensions	361 x 158 x 523 mm (W x H x D)
Weight	12.2 kg
Leak sensor	yes
Area of use	For indoor use only
Line voltage fluctuations do not exceed $\pm 10\%$ of normal voltage.	
Oversvoltage category II:	Energy consumers are supplied by a fixed device.
Permitted pollution degree	2
Temperature range	4-40 °C (39.2-104 °F)
Air humidity	below 90 %, non-condensing
Operating height	max. 2000 Meters above sea level

**Permitted  
operating  
environment**

## 12.4 Conditions for specification

Technical data has been determined in accordance with the ASTM standard E1657-98: "Standard Practice for Variable-Wavelength Photometric Detectors Used in Liquid Chromatography".

Reference conditions: test cell at wavelength 254 nm/8 nm with reference wavelength 360 nm/30 nm, time constant 2 s, data rate 1 Hz.

Linearity (5 %): Linearity is measured with caffeine at 274 nm/8 nm and time constant 2 s with a flow cell path length 10 mm.

Performance tests should be done with a completely warmed up optical unit (> 2 h). ASTM measurements require that the detector and/or lamp should be turned on at least 24 h before start of testing. ASTM drift tests require a temperature change below 2 °C/h over a 1 h period.



## 13. Reorders

This list for reorders is valid for the time the document has been published. Deviations afterwards are possible.

For reorders of spare parts use the enclosed packing list. Contact the Technical Support in case there are any questions on spare parts or accessories.

Further information on spare parts and accessories can be found online: [www.knauer.net](http://www.knauer.net)

### 13.1 Devices

	Name	Order No.
<b>DAD 6.1L</b>	Diode array detector DAD 6.1L with test cell	ADC11
<b>DAD 2.1L</b>	Diode array detector DAD 2.1L with test cell	ADC01
<b>MWD 2.1L</b>	Multi wavelength detector MWD 2.1L with test cell	ADB01
	Upgrade MWD 2.1L to DAD 2.1L	ADB01UMBAU

### 13.2 Accessories and spare parts

	Name	Order No.
<b>Instructions</b>	Instructions English/German	V6700
<b>Installation Qualification document</b>	DAD 6.1L, DAD 2.1L, MWD 2.1L	VIQ-DEVICE
<b>Operation Qualification document</b>	DAD 6.1L, DAD 2.1L, MWD 2.1L	VOQ_DAD
<b>Lamps</b>	High intensity deuterium lamp (for DAD 6.1L)	AZL01
	Halogen lamp (for DAD 6.1L)	AZL02
	Standard deuterium lamp (for DAD 2.1L and MWD 2.1L)	A5193
<b>Drainage system</b>	Corrugated hose, 16 cm, PE grey	A9846-1
	Funnel	P6431
	Exhaust	P6432
	Capillary guide top	P6424
	Capillary guide side	P6425
<b>Waste tubing kit</b>	Kit LightGuide flow cells 1/16"	A9842
	Kit UV flow cells 1/16"	A9843
	Kit UV flow cells 1/8"	A9844
<b>Mounting bracket</b>	Mounting bracket for flow cells	A9853-5
<b>Accessory kits</b>	AZURA accessory kit	FZA02
	DAD 6.1L, DAD 2.1L, MWD 2.1L accessory kit	FDC
<b>Tools</b>	Tool kit AZURA	A1033
	Luer-lock glass syringe, 10 ml	A0574

	<b>Name</b>	<b>Order No.</b>
	Kit for flow cell cleaning	A05052
<b>Test cell</b>	Cartridge test cell for AZURA® DAD/MWD detectors	AMLX8

### 13.3 Flow cells

	<b>Technical data</b>	<b>Order No.</b>	
<b>Standard KNAUER LightGuide Flow Cell Cartridge</b>	Path length	10 mm	AMC19XA
	Connection	1/16"	
	Volume	2 µl (0.8 µl dispersion vol.)	
	Wetted parts	PEEK, quartz, Teflon, Titanium, SSt	
	Max. flow rate	5 ml/min	
	Max. pressure	50 bar	
<b>High Sensitivity KNAUER LightGuide Flow Cell Cartridge</b>	Path length	50 mm	AMD59XA
	Connection	1/16"	
	Volume	6 µl (2 µl dispersion vol.)	
	Wetted parts	PEEK, quartz, Teflon, SSt	
	Max. flow rate	5 ml/min	
	Max. pressure	50 bar	
<b>Analytical KNAUER Pressure- Proof Flow Cell Cartridge (biocompatible)</b>	Path length	10 mm	AMC38
	Connection	1/16"	
	Volume	10 µl	
	Wetted parts	Titanium, quartz, PEEK	
	Max. flow rate	20 ml/min	
	Max. pressure	300 bar	
<b>Semi-Preparative KNAUER Pressure- Proof Flow Cell Cartridge (biocompatible)</b>	Path length	3 mm	AMB18
	Connection	1/16"	
	Volume	2 µl	
	Wetted parts	Titanium, quartz, PEEK	
	Max. flow rate	100 ml/min	
	Max. pressure	300 bar	

## 13.4 Flow cells with fiber optics

Technical data		Order No.
Path length	10 mm	A4074
Connection	1/16"	
Volume	10 µl	
Wetted parts	SSt, quartz, PFA	
Max. flow rate	20 ml/min	
Max. pressure	300 bar	
Path length	3 mm	A4044
Connection	1/16"	A4044HT
Volume	2 µl	(high temperature version)
Wetted parts	SSt, quartz, PTFE	
Max. flow rate	50 ml/min	
Max. pressure	300 bar	
Max. temperature	85°C (only valid for A4044HT)	
Path length	3 mm	A4047
Connection	1/16"	
Volume	2 µl	
Wetted parts	PEEK, quartz, PTFE	
Max. flow rate	50 ml/min	
Max. pressure	30 bar	
Path length	0.5 mm	A4089
Connection	1/16"	
Volume	3 µl	
Wetted parts	SSt, quartz, PTFE	
Max. flow rate	250 ml/min	
Max. pressure	200 bar	
Path length	0.5 mm	A4096
Connection	1/16"	
Volume	3 µl	
Wetted parts	PEEK, quartz, PTFE	
Max. flow rate	250 ml/min	
Max. pressure	100 bar	
Path length	0.5/1.25/2 mm	A4078
Connection	1/8"	
Volume	1.7/4.3/6.8 µl	
Wetted parts	SSt, quartz, PTFE	
Max. flow rate	1 000 ml/min	
Max. pressure	200 bar	

	Technical data	Order No.
	Path length	0.5 /1.25 /2 mm
	Connection	1/8"
	Volume	1.7/4.3/6.8 µl
	Wetted parts	PEEK, quartz, PTFE
	Max. flow rate	1 000 ml/min
	Max. pressure	100 bar
	Path length	0.5/1.25/2 mm
	Connection	1/4"
	Volume	1.7/4.3/6.8 µl
	Wetted parts	SSt, quartz, PTFE
	Max. flow rate	10 000 ml/min
	Max. pressure	200 bar
<b>Fiber optics adapter kit</b>	Including fiber optics adapter, fiber optic cables and mounting bracket Ideal for semi-preparative and preparative remote flow cells	AMKX8KIT

## 13.5 Fiber optic cables

Name	Order No.
2 x fiber optics, 750 mm	A0740
2 x fiber optics, 750 mm, high temperature up to 85°C	A0740HT
2 x fiber optics, custom made length	A0743

# 14. Chemical compatibility of wetted materials



**Note:** The user takes the responsibility for using the fluids and chemicals in an appropriate and safe way. If there is any doubt, contact the Technical Support of the manufacturer.

## 14.1 General

The device is very resistant against a variety of commonly used eluents. However, make sure that no eluents or water come in contact with the device or enter into the device. Some organic solvents (such as chlorinated hydrocarbons, ether) may cause coating damage or loosen glued components by improper handling. Even small quantities of other substances, such as additives, modifiers, or salts can influence the durability of the materials. Exposure time and concentration have a high impact on the resistance.

The following list contains information about the chemical compatibility of all wetted materials which are used in devices made by KNAUER. The data bases on a literature research on the manufacturer specifications of the materials. The wetted materials of this device are listed in the chapter "Technical data".

All resistances mentioned here are for use at temperatures up to 40 °C, unless stated otherwise. Please note that higher temperatures can significantly affect the stability of different materials.

## 14.2 Plastics

### Polyetheretherketone (PEEK)

PEEK is a durable and resistant plastic and, next to stainless steel, the standard material in HPLC. It can be used at temperatures up to 100 °C and is highly chemical resistant against almost all commonly used solvents in a pH range of 1 - 12.5. PEEK is potentially moderate resistant against oxidizing and reducing solvents.

Therefore, following solvents should not be used: Concentrated and oxidizing acids (such as nitric acid solution, sulfuric acid), halogenated acids (such as hydrofluoric acid, hydrobromic acid) and gaseous halogens. Hydrochloric acid is approved for most applications.

In addition, following solvents can have a swelling effect and may have an impact on the functionality of the built-in components: Methylene chloride, THF and DMSO in any concentration such as acetonitrile in higher concentrations.

### Polyethylene terephthalate (PET, outdated PETP)

PET is a thermoplastic and semi-crystalline material with high wear resistance. It is resistant against diluted acids, aliphatic and aromatic hydrocarbons, oils, fats and alcohols, but not against halogenated hydrocarbons and ketones. Since PET belongs chemically to esters, it is not compatible with inorganic acids, hot water and alkalis. Maximum operating temperature: up to 120 °C.

**Polyimide (Vespel®)**

This material is wear-resistant and permanent resilient thermally (up to 200 °C) as well as mechanically. It is chemically broadly inert (pH range 1-10) and is especially resistant against acidic to neutral and organic solvents, but vulnerable to pH strong chemical or oxidizing environments: It is incompatible with concentrated mineral acids (such as sulfuric acid), glacial acetic acid, DMSO and THF. In addition, it will be disintegrated by nucleophilic substances like ammonia (such as ammonium salts under alkaline conditions) or acetate.

**Ethylene-tetrafluorethylene copolymer (ETFC, Tefzel®)**

This fluorinated polymer is highly resistant against neutral and alkaline solvents. Some chlorinated chemicals in connection with this material should be handled with care. Maximum operating temperature is 80 °C.

**Perfluorethylenpropylen-Copolymer (FEP), Perfluoralkoxy-Polymer (PFA)**

These fluorinated polymers hold similar features as PTFE, but with a lower operation temperature (up to 205 °C). PFA is suitable for ultrapure applications, FEP can be used universally. They are resistant against almost all organic and inorganic chemicals, except elemental fluorine under pressure or at high temperatures and fluorine-halogen compounds.

**Polyoxymethylene (POM, POM-H-TF)**

POM is a semi-crystalline, high-molecular thermoplastic material which stands out due to its high stiffness, low friction value and thermic stability. It can even substitute metal in many cases. POM-H-TF is a combination of PTFE fibres and acetal resin and is softer and has better slip properties as POM. The material is resistant against diluted acids (pH > 4) as well as diluted lyes, aliphatic, aromatic and halogenated hydrocarbons, oils and alcohols. It is not compatible with concentrated acids, hydrofluoric acid and oxidizing agent. Maximum operating temperature is 100 °C.

**Polyphenylene sulfide (PPS)**

PPS is a soft polymer which is known for its high break resistance and very high chemical compatibility. It can be used with most organic, pH neutral to pH high, and aqueous solvents at room temperature without concerns. However, it is not recommended for using with chlorinated, oxidizing and reducing solvents, inorganic acids or at higher temperatures. Maximum operating temperature is 50 °C.

**Polytetrafluorethylene (PTFE, Teflon®)**

PTFE is very soft and anti-adhesive. This material is resistant against almost all acids, lyes and solvents, except against fluid sodium and fluoride compounds. In addition, it is temperature-resistant from -200 °C to +260 °C.

**Systec AF™**

This amorphous perfluorinated copolymer is inert against all commonly used solvents. However, it is soluble in perfluorinated solvents like Fluorinert® FC-75 and FC-40, and Fomblin perfluor-polyether solvents from Ausimont. In addition, it is affected by Freon® solvents.

**Polychlorotrifluoroethylene (PCTFE, Kel-F®)**

The semi-crystalline thermoplastic material is plasticizer-free and dimensionally stable, even in a wide temperature range (-240 °C to +205 °C). It is moderately resistant against ether, halogenated solvents and toluene. Halogenated solvents over +60 °C and chlorine gas should not be used.

**Fluorinated rubber (FKM)**

The elastomer consisting of fluorinated hydrocarbon stands out due to a high resistance against mineral oils, synthetic hydraulic fluids, fuels, aromatics, and many organic solvents and chemicals. However, it is not compatible with strong alkaline solvents (pH value > 13) like ammonia, and acidic solvents (pH value < 1), pyrrole and THF. Operating temperature is between -40 °C and +200 °C.

**Perfluorinated rubber (FFKM)**

This perfluoro elastomer has a higher fluorine content as fluorinated rubber and is therefore chemically more resistant. It can be employed at higher temperatures (up to 275 °C). It is not compatible with Pyrrole.

## 14.3 Non-metals

**Diamond-like carbon (DLC)**

This material is characterized by a high hardness, a low coefficient of friction and thus low wear. In addition, it is highly biocompatible. DLC is inert against all acids, alkalis and solvents commonly used in HPLC.

**Ceramic**

Ceramic is resistant against corrosion and wear and is fully biocompatible. An incompatibility against acids, alkalis and solvents commonly used in HPLC is not known.

**Alumina (Al<sub>2</sub>O<sub>3</sub>)**

Due to their high resistance to wear and corrosion, alumina ceramic is used as a coating for mechanically stressed surfaces. It is a biocompatible material with low thermal conductivity and low thermal expansion.

**Zirconium oxide (ZrO<sub>2</sub>)**

Zirconia ceramics are characterized by their high mechanical resistance, which makes them particularly resistant to wear and corrosion. It is also biocompatible, has low thermal conductivity and is resistant to high pressures.

**Sapphire**

Synthetic sapphire is virtually pure monocrystalline alumina. It is biocompatible and very resistant to corrosion and wear. The material is characterized by a high hardness and a high thermal conductivity.

**Ruby**

Synthetic ruby is monocrystalline alumina and gets its red color by the addition of some chromium oxide. It is biocompatible and very resistant to corrosion and wear. The material is characterized by a high hardness and a high thermal conductivity.

**Mineral wool**

This insulating material consists of glass or stone wool fibres and isolates in high oxidizing conditions and at high temperatures. Mineral wool is valid as commonly inert against organic solvents and acids.

**Glass, glass fibre, quartz, quartz glass**

These mineral materials are resistant against corrosion and wear and are mostly chemical inert. They are compatible with oils, fats and solvents and show a high resistance against acids and lyes up to pH values of 3-9. Concentrated acids (especially hydrofluoric acid) may embrittle and corrode the minerals. Lyes may ablate the surfaces slowly.

## 14.4 Metals

**Stainless steel**

Stainless steel is, apart from PEEK, the standard material in HPLC. Steels with WNr. 1.4404 (316L) are used, or with a mixture of higher compatibility.

They are inert against almost all solvents. Exceptions are biological applications which are metal ion sensible, and applications with extreme corrosive conditions. These steels, in comparison to commonly used steels, are increasingly resistant against hydrochloric acid, cyanides and other halogen acids, chlorides and chlorinated solvents.

The use in ion chromatography is not recommended. In case of electrochemical applications, a passivation has to be executed first.

**Hastelloy®-C**

This nickel-chrome-molybdenum alloy is extremely resistant to corrosion, especially against oxidizing, reducing and mixed solvents, even at high temperatures. This alloy may be used in combination with chlorine, formic acid, acetic acid and saline solutions.

**Titanium, titanium alloy (TiAl6V4)**

Titanium has a low weight and a high hardness and stability. It stands out due to its very high chemical compatibility and biocompatibility. Titan is applied when neither stainless steel nor PEEK are usable.



# 15. Index

## Symbole

3D data acquisition 9, 32

## A

absorption 10, 37, 38, 39  
ambient conditions 13, 60  
ambient temperature 13  
AVV-marking 61

## B

bandwidth 39  
baseline drift 10, 38

## C

capillary 18, 30  
  fitting 18, 58  
  layout 30  
Chemische Beständigkeit 71  
chromatogram 42  
Chromeleon 32  
ClarityChrom 32  
cleaning 50  
Company network 21  
conditions for specification 66  
control  
  Mobile Control 32  
  software operation 32  
cutoff 38

## D

data rate 10, 40  
  reference conditions 66  
dead volume 38  
decommissioning 59  
Decontamination Report 60  
default settings 33  
degasser 45  
detector 8  
  default settings 33  
  features 10  
  optimizing 36  
Disposal 61

## E

extended linear range 42

## F

fiber optics  
  adapter 17  
  flow cells 69  
  KNAUER Fiber Optics 10  
  remote operation 38  
Firmware Wizard:  
  Setting IP addresses 24-25

fitting  
  torque 30  
fittings 58  
  PEEK 18  
flow cell  
  adapter 17  
  cartridge 10, 37, 50, 68  
  cleaning 51  
  cleaning solution 53  
  fiber optics 17, 69  
  inserting 17  
  material 68  
  path length 37  
  pressure stability 38  
  replacing 54  
  selecting 36  
  volume 36  
Flushing solution 60  
Front view 8

## G

GLP data 10, 34  
  read out 50  
GROUND 26

## I

initial startup 13, 31  
Installation 13  
Installation Qualification (IQ) 43  
integration time 41  
integrator 29  
IP address  
  setting 22-25

## L

lamp 10  
  GLP 35  
  operating hours 50  
  replacing 55  
LAN  
  connect 19-21  
  connectors 9  
  default settings 33  
  Fehlerbehebung 44  
leak  
  management 10, 15  
  removing 58  
  sensor 34, 35  
  troubleshooting 47  
LED 32

## M

maintenance 49  
  contract 50  
  intervals 50  
mirror 9, 10

Mobile Control 32  
GLP data 10, 50  
Setting IP addresses 22-24

## O

Old devices 61  
OpenLAB 32  
operation  
operating hours 50  
Operation Qualification (OQ) 43  
operation site 13  
Original packaging 60

## P

path length 37  
peak broadening 37  
performance  
optimizing 36  
power  
switch on 31  
power supply 14  
pressure stability 38  
product information 68  
PurityChrom 32

## R

Rear view 9  
reference wavelength 39, 66  
refractive index 38  
reset  
default settings 33  
response time 40  
Router 20

## S

selectivity 38, 39  
self-validation  
switch on 31  
sensitivity 10, 36, 38, 39  
serial number 9  
Service request form 60  
signal level 41  
signal wavelength 38  
software 32  
Solvent  
Disposal 61  
Space requirement 14  
spectral range 40  
standby 33  
storage 60  
subtraction  
baseline 42  
system  
integration 30  
system messages 46

## T

temperature control 10  
terminal strip 27  
time constant 40  
transport 60

## U




unpacking 13

## W

warmup time 36  
wavelength 38  
WEEE Registration Number 61  
weight 60  
wetted parts 38

## **Appendix: Installation Qualification (IQ)**

### Installation Qualification (IQ) for a Device

	Created	Reviewed	Approved
Function	Technical editor	Engineering	Head of Quality
Name	Anna Erben	Paul Pietsch	Kate Monks
Date	23/08/2022	29/08/2022	30/08/2022
Signature	 <small>Digital unterschrieben von Anna Erben Datum: 2022.08.23 14:09:27 +02'00'</small>		

#### 0. Customer approval

Prior to installation at the customer site, the customer has reviewed the OQ document and agrees with the design and scope

Company name:

Name	Function	Reviewed & approved	Date	Signature

## Installation Qualification (IQ) for a Device

### 1. Definition of the Installation Qualification

The qualification document „Installation Qualification (IQ)“ is part of the quality management system at the company KNAUER Wissenschaftliche Geräte GmbH.

### 2. Scope

The customer can request the Installation Qualification. In case of a request, the technical support of KNAUER or a provider authorized by KNAUER performs this functionality test during the installation. The IQ is a standardized document and includes the following:

- Confirmation of flawless condition at delivery
- Check if the delivery is complete
- Certification on the functionality of the device

### 3. Instructions

All deviations from the specifications that occurred during installation have to be recorded in this document.

In addition, all measures taken to eliminate the deviations have to be noted down as comments in the list of rectifications (LOR) on page 4.

If certain items in the report are not applicable, this has to be indicated in the table as „N/A“ (not applicable). Major sections that are not used have to be crossed out (diagonal line), marked „N/A“, dated and signed.

All required documents have to be completed by the end of the installation. The document has to be reviewed and approved by an authorized person. The review and approval have to be documented with signature and date (DD/MM/YYYY).

The tests have to be carried out in a suitable environment, as described in the user instruction of the device.

### 4. About this document

The information in this document is subject to change without prior notice. This document may not be used, reproduced or translated without written consent of KNAUER Wissenschaftliche Geräte GmbH. Depending on the customer's quality assurance system, the signed document either has to be filed in the device folder or scanned and stored in an electronic archive.

### 5. Device data

Device name		Product number	
Serial number		Order number	
Firmware version			
Installation location			

### 6. Customer and manufacturer data

	Customer	Manufacturer
Company		KNAUER Wissenschaftliche Geräte GmbH
Customer number		-
Contact person/agent		
Address		Hegauer Weg 38
Postal Code/City		14163 Berlin
Phone		+49 30 80 97 27 111
E-Mail		support@knauer.net

## Installation Qualification (IQ) for a Device

### 7. Installation Qualification Tests

Test	Description	Specification	Passed	Failed	N/A	Comment/LOR No.
1	Identify the device.	The name on the device matches the name on the delivery order.				
2	Check the device for transport damage.	No transport damage is observed.				
3	Check the scope of delivery.	The scope of delivery matches the packing list and/or the delivery order.				
4	Check that the technical documentation provided is correct and complete (material documentation of wetted parts, calibration certificates etc.)	The documentation is correct and complete.				
5	Check that all equipment is properly and correctly labeled according to the delivery order and/or the labeling specifications document, if applicable.	The equipment is labeled correctly.				
6	Connect all loose parts (e.g. capillaries, tubings, measuring head) according to the user instructions.	The device is fully assembled and ready to use.				
7	Ensure that the installation site is suitable according to the user instructions.	The installation site matches the specifications in the user instructions.				
8	Connect the device to the power supply and switch it on.	The device starts (operating noise). The power LED or the display lights up.				

## Installation Qualification (IQ) for a Device

### 8. List of rectifications (LOR)

LOR No.	Test No.	Type of deviation*	Description of the deviation	Action plan	Persons responsible	Due date	Date/signature

\* Type of deviation:

A = acceptable (e.g. not a GMP-critical deviation)

N = not acceptable

Continuation of qualification activities into the next qualification phase is only possible when deviation is rectified.

T = temporarily acceptable

a) Release and use of the system is possible, even when the deviation is not rectified.

b) A continuation of qualification activities into the next qualification phase is possible, even when the deviation is not rectified

## Installation Qualification (IQ) for a Device

### 9. List of changes to the document

Revision no.	Description of change	Additional information	Date/signature



## Installation Qualification (IQ) for a Device

### 10. Certificate and approval

A KNAUER employee or an employee authorized by KNAUER has checked the device and performed all tests described in the IQ.

The IQ form has to be signed by an authorized person. The scope of the IQ meets the customer’s requirements.

The results of the IQ, any changes made as well as the IQ process have been documented in this form in writing. The users listed below were instructed and are familiar with how to operate the device. Both parties confirm that the IQ has been performed to the customer’s satisfaction by signing it.

#### 10.1 Customer approval

Name	Function	Date	Signature

#### 10.2 KNAUER agent approval

Name	Function	Date	Signature

### 11. Comments / recommendations

---



---



---

### Installation Qualification (IQ) for a Device

**Appendix: List of supporting documents**

No.	Test no.	Description

Science with Passion



Latest KNAUER instructions online:  
[www.knauer.net/library](http://www.knauer.net/library)

**KNAUER**  
Wissenschaftliche Geräte GmbH  
Hegauer Weg 38  
14163 Berlin

Phone: +49 30 809727-0  
Fax: +49 30 8015010  
E-mail: [info@knauer.net](mailto:info@knauer.net)  
Internet: [www.knauer.net](http://www.knauer.net)