

*Azura*

## pH Monitor pH 2.1S

### Instructions





**Note:** For your own safety, read the instructions and observe the warnings and safety information on the device and in the instructions. Keep the instructions for future reference.



**Note:** In case you require this instruction in another language, please submit your request including the corresponding document number via e-mail or fax to KNAUER.

**Support:** Do you have questions about the installation or the operation of your instrument or software?

**International Support:**

Contact your local KNAUER partner for support:

[www.knauer.net/en/Support/Distributors-worldwide](http://www.knauer.net/en/Support/Distributors-worldwide)

**Support in Germany**

(Austria & Switzerland on case-to-case basis):

Phone: +49 30 809727-111 (workdays 9-17h CET)

Fax: +49 30 8015010

E-mail: [support@knauer.net](mailto:support@knauer.net)

**Publisher:** KNAUER Wissenschaftliche Geräte GmbH

Hegauer Weg 38

14163 Berlin

Germany

Phone: +49 30 809727-0

Fax: +49 30 8015010

Internet: [www.knauer.net](http://www.knauer.net)

E-mail: [info@knauer.net](mailto:info@knauer.net)

**Version information:** Document number: V6733

Version number: 1.0

Release date: February 07, 2023

Translation of the original edition

These instructions apply to devices with the product number:  
EDG31



The information in this document is subject to change without prior notice. For the latest version of the instructions, visit our website: [www.knauer.net/library](http://www.knauer.net/library)

**Sustainability:** The printed versions of our instructions are printed according to Blue Angel standards ([www.blauer-engel.de/en/uz195](http://www.blauer-engel.de/en/uz195)).

**Copyright:** This document contains confidential information and may not be reproduced without written consent of KNAUER Wissenschaftliche Geräte GmbH.

© KNAUER Wissenschaftliche Geräte GmbH 2023  
All rights reserved.

AZURA® is a registered trademark of  
KNAUER Wissenschaftliche Geräte GmbH.

---

# Table of contents

<b>1. General</b>	<b>1</b>
1.1 About these instructions	1
1.2 Signal words	1
1.3 Additional typographical conventions	1
1.4 Legal information	2
1.4.1 Liability limitation	2
1.4.2 Transport damage	2
1.4.3 Warranty conditions	2
1.4.4 Warranty seal	2
1.4.5 Declaration of conformity	2
<b>2. Basic safety instructions</b>	<b>3</b>
2.1 Intended use	3
2.1.1 Operating ranges	3
2.1.2 Foreseeable misuse	3
2.2 User qualification	3
2.3 Operator responsibility	4
2.4 Personal safety equipment	4
2.5 Specific environments	4
2.5.1 Earthquake-endangered areas	4
2.5.2 Explosive environment	5
2.5.3 Cooling room	5
2.5.4 Wet room	5
2.6 Maintenance, care and repair	5
2.7 Service request form and decontamination report	5
<b>3. Product information</b>	<b>6</b>
3.1 Features	6
3.2 Device views	6
3.3 Symbols and signs	7
3.4 Scope of delivery	7
3.5 Eluents/buffers	8
3.5.1 Suitable eluents/buffers	8
3.5.2 Unsuitable eluents/buffers	8
<b>4. Installation</b>	<b>9</b>
4.1 Setup	9

4.1.1	Location requirements . . . . .	9
4.1.2	Unpacking . . . . .	10
4.1.3	Integration into the FPLC/HPLC System . . . . .	10
4.2	AZURA® pH sensor . . . . .	11
4.2.1	Implementing the AZURA® pH flow cell into the chromatography system. . . . .	11
4.2.2	Assembling pH sensor and attaching to pH monitor AZURA® pH 2.1S. . . . .	12
4.3	Connecting the device to the computer . . . . .	13
4.3.1	Connecting the device to the computer via LAN . . . . .	13
4.3.2	Configuring the LAN settings . . . . .	13
4.3.3	Connecting devices to the LAN . . . . .	14
4.3.4	Configuring the router. . . . .	15
4.3.5	Integrating the LAN into a company network . . . . .	15
4.3.6	Controlling several systems separately in a LAN. . . . .	15
4.4	Setting IP addresses via software . . . . .	16
4.4.1	Firmware Wizard: Setting a static IP address . . . . .	16
4.4.2	Firmware Wizard: Setting a dynamic IP address . . . . .	17
4.5	Power connection . . . . .	17
<b>5.</b>	<b>Operation . . . . .</b>	<b>19</b>
5.1	Initial start-up . . . . .	19
5.2	Switch on. . . . .	19
5.2.1	Operating elements . . . . .	19
5.2.2	Menu items and factory settings . . . . .	20
5.3	Selecting the interface . . . . .	20
5.4	Checking the operating hours. . . . .	21
5.5	Calibrating the pH electrode . . . . .	21
5.6	Switching off device . . . . .	23
<b>6.</b>	<b>Functionality tests . . . . .</b>	<b>24</b>
6.1	Installation Qualification (IQ) . . . . .	24
6.2	Operation Qualification (OQ) . . . . .	24
<b>7.</b>	<b>Troubleshooting. . . . .</b>	<b>25</b>
7.1	LAN. . . . .	25
7.2	Possible problems and solutions. . . . .	26
<b>8.</b>	<b>Maintenance and care . . . . .</b>	<b>27</b>
8.1	Maintenance contract . . . . .	27
8.2	Cleaning the device. . . . .	27
8.3	Flushing and cleaning the pH sensor. . . . .	27

---

8.3.1	Cleaning pH electrode.....	27
8.3.2	Cleaning pH flow cell.....	28
8.4	Replacing pH electrode.....	28
<b>9.</b>	<b>Transportation and storage.....</b>	<b>29</b>
9.1	Preparing wetted components.....	29
9.2	Disassembling the device.....	29
9.2.1	Disconnecting the power supply.....	29
9.2.2	Removing the pH sensor.....	29
9.3	Storing the device.....	30
9.3.1	Storage of the pH monitor.....	30
9.3.2	Storage of the pH sensor.....	30
<b>10.</b>	<b>Disposal.....</b>	<b>31</b>
10.1	AVV marking in Germany.....	31
10.2	WEEE registration.....	31
10.3	Solvents and other operating materials.....	31
<b>11.</b>	<b>Technical data.....</b>	<b>32</b>
<b>12.</b>	<b>Chemical compatibility of wetted materials.....</b>	<b>33</b>
12.1	General.....	33
12.2	Plastics.....	33
12.3	Non-metals.....	35
12.4	Metals.....	36
<b>13.</b>	<b>Repeat orders.....</b>	<b>37</b>

# 1. General

## 1.1 About these instructions

These operating instructions enable the safe and efficient operation of the device. The user must have carefully read and understood these operating instructions before starting any work.





The basic prerequisite for safe operation is compliance with all safety instructions (see chapter "2 Basic safety instructions", p. 3). In addition to the safety and warning instructions in these operating instructions, the local accident prevention regulations and the national industrial safety regulations apply.

These operating instructions are an integral part of the device. It must be kept in the immediate vicinity of the device and accessible to the user at all times.

You can download these and other instructions from the KNAUER website: [www.knauer.net/library](http://www.knauer.net/library)

## 1.2 Signal words

Possible dangers related to the device are distinguished in personal and material damages.

Symbol	Meaning
	DANGER (red) indicates a highly hazardous situation. If not avoided, it will result in death or serious injury.
	WARNING (orange) indicates a hazardous situation. If not avoided, it could result in death or serious injury.
	CAUTION (yellow) indicates a moderate hazardous situation. If not avoided, it could result in minor or moderate injury.
	NOTICE (blue) is used to address issues which are not related to physical injury.

## 1.3 Additional typographical conventions

Note: Specific information are prefixed with the word "Note" and an information icon.

 **Note:** This is an example.

## 1.4 Legal information

### 1.4.1 Liability limitation

The manufacturer is not liable for the following issues:

- Non-compliance of these instructions
- Non-observance of necessary safety precautions
- Improper use
- Operation of the device by unqualified personnel (see chapter "2.2 User qualification", p. 3)
- Use of non-approved spare parts
- Technical changes by the user such as opening the device and unauthorized modifications
- Violations of General Terms and Conditions (GTC)

### 1.4.2 Transport damage

The packaging of our devices provides the best possible protection against transport damage. However, check the packaging for transport damage. In case you notice any damage, inform the technical support and the shipping company within three workdays.

### 1.4.3 Warranty conditions

For information on warranty please refer to our general terms and conditions on the website: [www.knauer.net/terms](http://www.knauer.net/terms)

### 1.4.4 Warranty seal

A blue or orange warranty seal is affixed to some devices.

- A blue seal is used by KNAUER's Manufacturing or Customer Support for devices to be sold.
- After repair, service technicians attach an orange seal onto the identical position.

After repair, the service technician affixes an orange seal in the same place. If unauthorised persons tamper with the device or if the seal is damaged, the warranty will lapse.



### 1.4.5 Declaration of conformity

The declaration of conformity is enclosed as a separate document with the product and can be obtained online: [www.knauer.net/en/Support/Declarations-of-conformity](http://www.knauer.net/en/Support/Declarations-of-conformity).

## 2. Basic safety instructions

The device has been developed and constructed in such a way that hazards arising from its intended use are largely excluded. Nevertheless, the following safety instructions must be observed in order to exclude residual hazards.

### 2.1 Intended use



**Note:** Only use the device for applications that fall within the range of the intended use. Otherwise, the protective and safety equipment of the device could fail.

- Description** The pH monitor pH 2.1S can be connected to an pH electrode and fitting pH flow cell in order to measure the pH in aqueous buffers. The monitor itself is the processing device and only functional in combination with a pH electrode and flow cell.
- Operating Range** The monitor is used for pH monitoring in the following areas:
- Biochromatography
  - Process analysis
  - Biochemical analysis
  - Pharmaceutical analysis
  - Environmental analysis

#### 2.1.1 Operating ranges

The device is intended to be used indoors for chromatographic applications.

#### 2.1.2 Foreseeable misuse

Refrain from the use of the device for the following purposes or conditions:

- Medical purposes. The device is not approved as a medical product.
- Operating outdoors. Otherwise, the manufacturer does not guarantee the functionality and safety of the device.
- Operation in potentially explosive areas without special and additional explosion protection. Contact the KNAUER Customer Support for more information.

### 2.2 User qualification

The users are qualified to handle the device if all of the following points apply:

- They have at least a basic knowledge of liquid chromatography.
- They have knowledge about the properties of the used solvents and their health risks.
- They are trained for the special tasks and activities in the laboratory and know the relevant standards and regulations.
- Due to their technical training and experience, they can understand and carry out all the work described in the operating instruc-



tions on the instrument and recognize and avoid possible dangers independently.

- Their ability to react is not impaired by the consumption of drugs, alcohol or medication.
- They have participated in the installation of an instrument or training by KNAUER or an authorized company.

If users do not meet these qualifications, they must inform their supervisors.

## 2.3 Operator responsibility

The operator is any person who operates the device himself or leaves it to a third party for use and who bears the legal product responsibility for the protection of the user or third parties during operation.

The obligations of the operator are listed below:

- Know and follow the applicable work safety regulations
- Identify hazards arising from the working conditions at the place of use in a risk assessment.
- Set up operating instructions for the operation of the device.
- Regularly check whether the operating instructions correspond to the current status of the regulations.
- Clearly regulate and specify responsibilities for installation, operation, troubleshooting, maintenance and cleaning and set clear rules
- Ensure that all personnel who work with the device have read and understood these operating instructions
- Train the personnel who work with the device at regular intervals and inform them about the dangers.
- Provide the necessary safety equipment to the employees working with the unit (see section below).

## 2.4 Personal safety equipment

The protective measures required in the laboratory must be observed and the following protective clothing worn during all work on the device:

- Safety glasses with side protection
- Protective gloves in accordance with the prevailing ambient conditions and used solvents (e.g. heat, cold, protection against chemicals)
- Lab coat
- Personalised protective safety equipment which is specified in the particular laboratory.

## 2.5 Specific environments

### 2.5.1 Earthquake-endangered areas

In earthquake-endangered areas, do not stack more than 3 devices on top of each other. Otherwise there is risk of injury due to falling devices or loose parts.

## 2.5.2 Explosive environment

Never use the system in potentially explosive atmospheres without appropriate protective equipment. For more information, contact the KNAUER Customer Support.

## 2.5.3 Cooling room

You may operate the device in a cooling room. To prevent condensation, note the following instructions:

- Allow the device to acclimatize for min. 3 hours before taking it into operation.
- After taking into operation, the device should stay switched on.
- Avoid temperature fluctuations.

## 2.5.4 Wet room

The device must not be operated in wet rooms.

## 2.6 Maintenance, care and repair

- Avoiding electric shock: Before performing any maintenance and service work, disconnect the device from the power supply.
- Tools: Use only tools recommended or prescribed by the manufacturer.
- Spare parts and accessories: Only use original parts and accessories made by KNAUER or a company authorized by KNAUER.
- PEEK fittings: Use PEEK fittings only for a single port or brand-new PEEK fittings in order to avoid dead volume or not exactly fitting connections.
- Column care: Follow KNAUER or other manufacturer's instructions on caring for the columns (see [www.knauer.net/columncare](http://www.knauer.net/columncare))
- Used capillaries: Do not use any used capillaries elsewhere in the system in order to avoid dead volumes, not exactly fitting connections and spreading contamination.
- Safety features: The device may only be opened by the KNAUER Customer Support of KNAUER or any company authorized by KNAUER (see chapter "1.4.1 Liability limitation", p. 2).
- For more information visit the KNAUER website: [www.knauer.net/hplc-troubleshooting](http://www.knauer.net/hplc-troubleshooting)

## 2.7 Service request form and decontamination report

Devices which are shipped without the completed document "Service request form and decontamination report" will not be repaired. If you would like to return a device to KNAUER, make sure to enclose the completed document: [www.knauer.net/servicerequest](http://www.knauer.net/servicerequest).

## 3. Product information

### 3.1 Features

The AZURA pH 2.1S is monitoring the pH value of buffers in liquid chromatography systems. It is used for the value read out from the electrode and subsequent data exchange with the chromatography software.

**Flow cells** KNAUER offers two different flow cells, which need to be ordered separately. The flow cell A1943 can be used for flowrates up to 100 ml/min with 1/16" or 1/8" tubing and the flow cell A1946 can be used up to 1000 ml/min with 1/8" or 3/16" tubing. You can integrate the pH sensor by placing the pH flow cell flexibly into the AZURA® system.

The AZURA® pH 2.1S consists of a pH electrode and a flow cell. You can integrate the AZURA® pH sensor (A70091-2/A70091-3) by placing the pH flow cell into the AZURA® system via various options (further information see [supplement V6760](#)). These items are not included in the scope of delivery and can be purchased separately.

### 3.2 Device views

#### Legend:

- ① Display
- ② Arrow keys
- ③ Connection for pH electrode

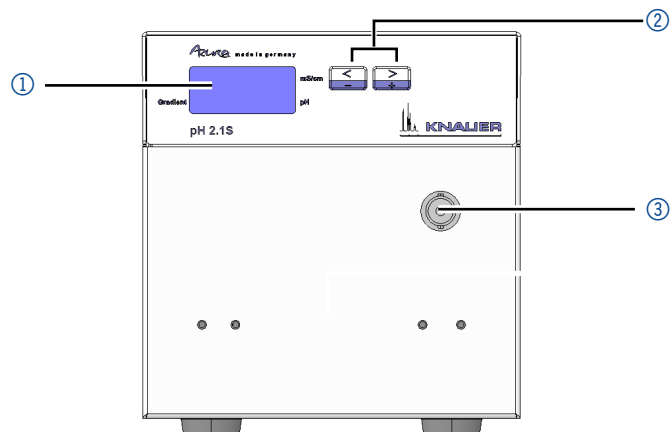

**Fig. 1:** Front view

#### Legend:

- ④ LAN connector
- ⑤ RS-232 connector
- ⑥ Power connection
- ⑦ Ground

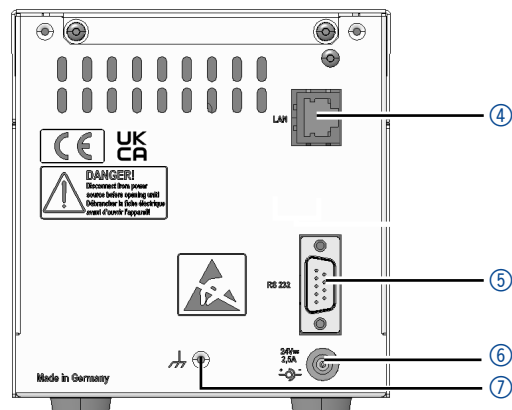

**Fig. 2:** Rear view

### 3.3 Symbols and signs

The following symbols and labels are located on the device:

Symbol	Description
	Electrostatic discharge hazard, damages to system, device, or components can occur.
	Hazard due to high voltage.
	A device or system marked with CE fulfills the product specific requirements of European directives. This is confirmed in a Declaration of Conformity.
	The device complies with the product-specific requirements of the United Kingdom.

### 3.4 Scope of delivery



**Note:** Only use original parts and accessories made by the manufacturer or a company authorized by the manufacturer.

- AZURA® pH monitor pH 2.1S
- Instructions (V6733)
- Power connection 110 V - 240 V, voltage output: 24 V/60 W
- Power cable

### 3.5 Eluents/buffers

Refer to the following listing for eluent selection.

Even small quantities of other substances, such as additives, modifiers, or salts can influence the durability of the materials. If there is any doubt, contact the technical support of the manufacturer.



**Note:** The list of selected solvents was compiled based on research in the pertinent literature and is only a recommendation by KNAUER.

#### 3.5.1 Suitable eluents/buffers

pH flow cell

##### Eluents/buffers suitable for pH flow cell

- Aqueous buffer solutions (such as acetate, formiate, phosphate) with pH 1 to 13 (pH 0 to 14 for short time exposure)
- Aqueous salt solutions (such as potassium and sodium halides or hydroxides with pH 1 to 13 (pH 0 to 14 for short time exposure)
- Acetone
- Ammoniated dilute solution
- Carbon dioxide
- Dilute acetic acid
- Ethanol
- Ethyl acetate
- Isopropanol
- Methanol
- Toluol
- Water

pH electrode

##### Eluents/buffers suitable for pH electrode or glass electrodes in general

- Aqueous salt or buffer solutions



Also observe the operating instructions of the pH electrode for suitable eluents or contact the manufacturer.

#### 3.5.2 Unsuitable eluents/buffers



**Note:** To estimate, which solvents or solution are unsuitable for the pH flow cell, refer to chap. 12.

The wetted parts are:

- pH flow cell: PEEK (body), FFKM (sealing ring), and ETFE (ferrule)

pH flow cell

##### Eluents/buffers unsuitable for pH flow cell

- Acetonitril

## pH electrode

Eluents/buffers unsuitable for pH electrode or glass electrodes in general

**Media that can dissolve the glass surface, for example:**

- Hydrofluoric acid solutions
- Acidified fluoride solutions
- Concentrated alkalis

**Media that can dehydrate the glass surface, for example:**

- Ethanol
- Sulfuric acid
- Purified or demineralized water is not suitable as a storage medium
- Media with components that can adhere to the glass surface
- Media with organic content



**Note:** Be sure to observe the separate storage regulations for pH flow cell and pH electrode.

## 4. Installation

### 4.1 Setup

When installing the device, please pay attention to the suitability of the location according to the requirements. The setup requirements and a description can be found in the following section.

#### 4.1.1 Location requirements

**NOTICE****Device defect**

The device overheats at exposure to sunlight and insufficient air circulation. Device failures are very likely.

- ➔ Set up the device in such a way that it is protected against exposure to direct sunlight.
- ➔ Leave room for air circulation: See paragraph „space requirements“.

- Sunlight: Protect the device against direct exposure to sunlight.
- A/C system: Set up the device at a location not exposed to air drafts.
- Vibration: Do not set up the device in the vicinity of other machines that cause floor vibrations.

## 4.1.2 Unpacking

**Prerequisite** There is no noticeable damage to the packaging.

**Tools** Utility knife

### Process

1. Place the package in such a way that you can read the label. Using the utility knife, cut the adhesive tape and open the packaging.
2. Remove the foam insert. Take out the accessories kit and the manual.
3. Open the accessories kit. Check the scope of delivery. In case any parts are missing, contact the technical support.
4. Clasp the device at its side panels and lift it out of the packaging.
5. Remove the foam inserts from the device.
6. Check the device for signs of damage that occurred during transport. In case you notice any damage, contact the technical support.
7. Set up the device in its location.
8. Remove the protective foil.

**Next steps** Store all packaging material.

## 4.1.3 Integration into the FPLC/HPLC System

Integrate the pH monitor into the FPLC/HPLC system. In case you want to use the pH monitor together with an UV detector and a pH sensor in one system, position the monitor behind the UV detector and before the pH flow cell, as the pH sensor typically has the lowest burst pressure value.

### Legend:

- ① Solvent bottles
- ② Solvent tray
- ③ Binary pump
- ④ Injection valve
- ⑤ Column
- ⑥ Flow cell of UV detector
- ⑦ Mikron 81
- ⑧ pH monitor AZURA® pH 2.1S
- ⑨ AZURA® pH flow cell
- ⑩ AZURA® pH electrode
- ⑪ AZURA® Organizer
- ⑫ Fraction collector

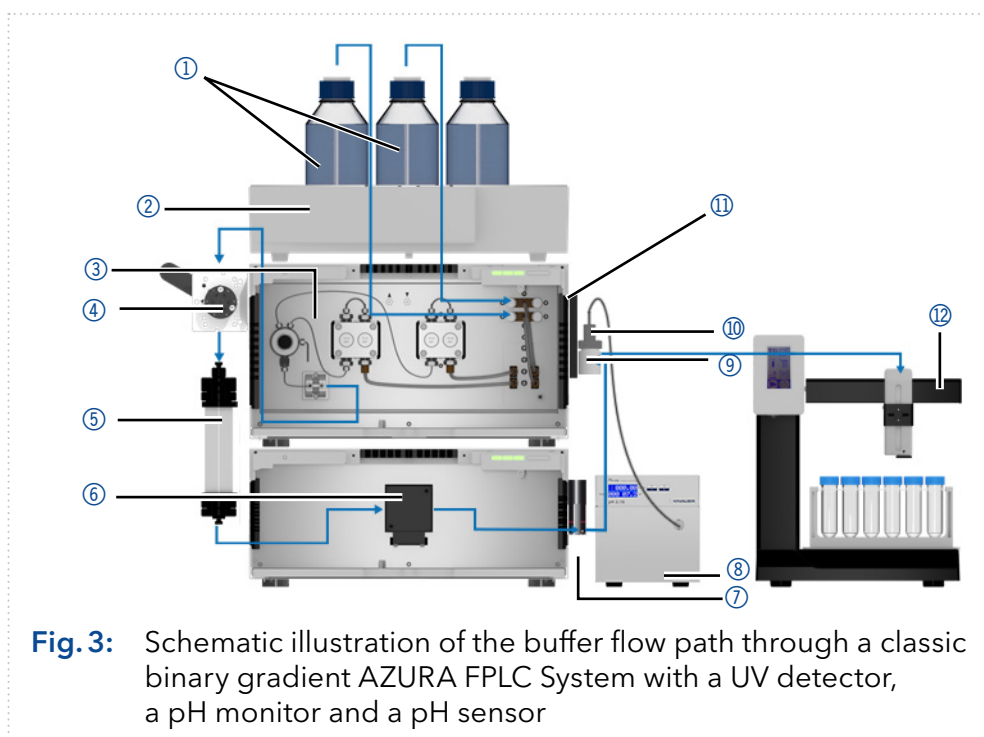

**Fig. 3:** Schematic illustration of the buffer flow path through a classic binary gradient AZURA FPLC System with a UV detector, a pH monitor and a pH sensor

## 4.2 AZURA® pH sensor

When connected to the pH 2.1S, the pH sensor is used to monitor the pH value of aqueous solutions such as buffers in flow. The pH sensor consists of a pH electrode and a pH flow cell.

When flushing the pH sensor under non-compatible flow, pressure or solvent composition conditions, the pH electrode should be excluded from the flowpath (see [AZURA® pH flow cell supplement V6760](#)). If the pH electrode is not plugged into the socket of the pH 2.1S (s. Fig. 1, nr. ③), cover the socket using the BNC blind plug.

### Legend:

- ① AZURA® pH flow cell
- ② Adapter plate
- ③ Universal AZURA® Click mounting rail holder
- ④ Cap nut
- ⑤ AZURA® pH electrode with protective sleeve
- ⑥ AZURA® pH dummy electrode
- ⑦ BNC blind plug

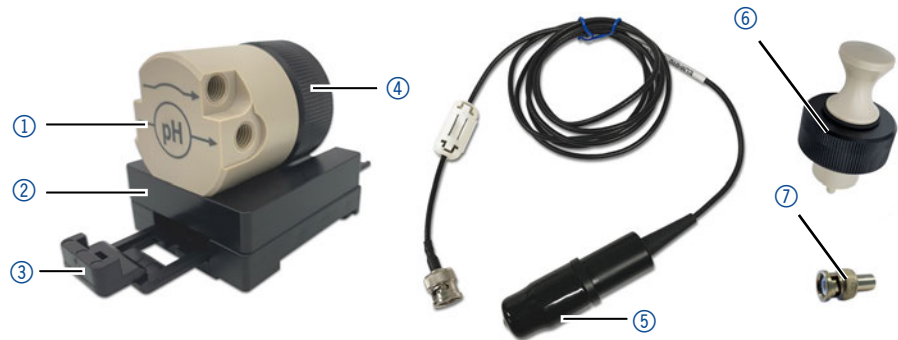

**Fig. 4:** AZURA® pH flow cell, AZURA® pH electrode, AZURA® pH dummy electrode and BNC blind plug

### 4.2.1 Implementing the AZURA® pH flow cell into the chromatography system

**Process** Mount the AZURA® pH flow cell onto an AZURA® L-sized modul. Connect it downstream of the UV-detector/conductivity monitor and upstream of the waste or fraction collector (see Fig. 3) via the system capillaries (see [supplement V6760](#)).

### Legend:

- ① Inlet
- ② Blind fitting (2x)
- ③ Bypass
- ④ Outlet
- ⑤ AZURA® Click mounting rail
- ⑥ Universal AZURA® Click mounting rail holder
- ⑦ AZURA® pH flow cell

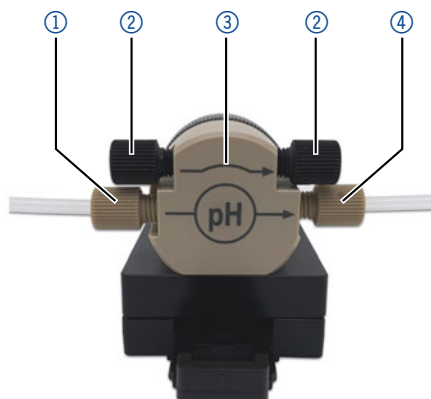

**Fig. 5:** Exemplary connection of an AZURA® pH flow cell with 1/8"-OD tubing



**Fig. 6:** Exemplary positioning of the AZURA® pH flow cell onto an AZURA® L-sized modul via AZURA® Click mounting rail holder



**Next steps** Connect the AZURA® pH electrode to the AZURA® pH 2.1S and the AZURA® pH flow cell (see next chapter).

## 4.2.2 Assembling pH sensor and attaching to pH monitor AZURA® pH 2.1S

- Prerequisites**
- The AZURA® pH 2.1S is switched off.
  - The AZURA® pH flow cell has been implemented within the system.



**Note:** Carry out the following process only if you want to perform a measurement afterwards.

Process	Figure
<p>1. Screw the cap nut ① off the pH flow cell ② and pull it over the cable of the pH electrode ③.</p>	
<p>2. Connect the plug of the electrode to the socket ③ on the front side of the monitor.</p>	
<p>3. Remove the protective sleeve ④ from the pH electrode ⑤.</p>	
<p>4. Calibrate the electrode (see "5.5 Calibrating the pH electrode" on page 21).</p>	

## Process

## Figure

5. Insert the pH electrode ⑥ into the pH flow cell ⑧ and tighten the cap nut ⑦.



**Note:** Make sure to flush the AZURA pH sensor with solvent compatible for the AZURA pH electrode immediately after to prevent damaging the pH electrode. Make sure that the maximum backpressure of 5 bar is not exceeded in this configuration.

**Next step** Connect the pH 2.1S to the computer.

## 4.3 Connecting the device to the computer

### 4.3.1 Connecting the device to the computer via LAN



**Note:** HPLC devices made by KNAUER work only with IP addresses which are assigned via IPv4. IPv6 is not supported.

This section describes how to set up an HPLC system in a local area network (LAN) and how a network administrator can integrate this LAN into your company network. The description applies to the operating system Windows and all conventional routers.

To set up a LAN, we recommend to use a router. That means the following steps are required:

**Process** On the computer, go to the control panel and check the LAN properties.

1. Hook up the router to the devices and the computer.
2. On the computer, configure the router to set up the network.
3. Install the chromatography software from the data storage device.
4. Switch on the device and run the chromatography software.

### 4.3.2 Configuring the LAN settings

The LAN uses only one server (which is normally the router) from that the devices automatically receive their IP address.

- Prerequisites**
- In Windows®, power saving, hibernation, standby, and screen saver must be deactivated.
  - In case you use an USB-to-COM box, the option „Allow the computer to turn off this device to save power“ in the Device Manager must be deactivated for all USB hosts.

- For all LAN devices: For the network adapter, the following option in the Device Manager must be deactivated: „Allow the computer to turn off this device to save power“.

**Procedure****Process**

1. In Windows, open <Network and Sharing Center>.
2. Double-click on <LAN connection>.
3. Click on the button <Properties>.
4. Select <Internet Protocol version 4 (TCP/IPv4)>.
5. Click on the button <Properties>.
6. Check the settings in the tab <General>. The correct settings for the DHCP client are:
  - a) Obtain an IP address automatically
  - b) Obtain DNS server address automatically
7. Click on the button <OK>.

### 4.3.3 Connecting devices to the LAN

A router ② has several LAN ports ③ and one WAN port ④ that can be used to integrate the LAN into a wide area network (WAN), e.g. a company network or the Internet. In contrast, the LAN ports serve to set up a network from devices ① and a computer ⑤. To avoid interference, we recommend operating the HPLC system separately from the company network.

You will find patch cables for each device and the router in the accessories kit. To connect the router to a WAN, an additional patch cable is required, which is not supplied within the scope of delivery.

**Legend**

- ① Devices
- ② Router
- ③ LAN ports
- ④ WAN/Internet connection
- ⑤ Computer

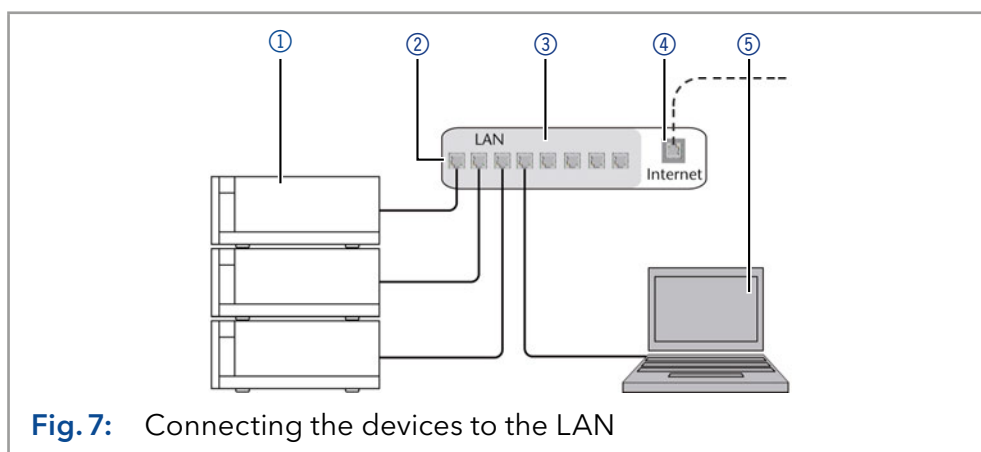

**Fig. 7:** Connecting the devices to the LAN

**Prerequisites**

- The computer has been switched off.
- There is a patch cable for each device and the computer.

**Process**

1. Use the patch cable to connect the router and the computer.
2. With additional patch cables, connect all devices individually with the router.
3. Use the power supply to connect the router to the mains power system.

**Nest step**

- Configure the router.

### 4.3.4 Configuring the router

The router is preset at the factory. You find information about IP address, user name and password in the router instructions:

[www.knauer.net/router](http://www.knauer.net/router)

- Process**
1. To open the router configuration, start your Internet browser and enter the IP address (not for all routers).
  2. Enter user name and password.
  3. Configure the router as DHCP server.
  4. In the router configuration, check the IP address range and make changes if necessary.



**Note:** If the IP address range has been changed, you must note this.

**Result** Once the router has assigned IP addresses to all devices, the chromatography software can be used to remotely control the system.

### 4.3.5 Integrating the LAN into a company network

A network administrator can integrate the LAN into your company network. In this case you use the WAN port of the router.

**Prerequisite** There is a patch cable for the connection.

- Process**
1. Check that the IP address range of the router and of the company network do not overlap.
  2. In case of an overlap, change the IP address range of the router.
  3. Use the patch cable to connect the router WAN port to the company network.
  4. Restart all devices, including the computer.

### 4.3.6 Controlling several systems separately in a LAN

Devices connected to a LAN communicate through ports, which are part of the IP address. If more than one HPLC system is connected to the same LAN and you plan on controlling them separately, you can use different ports to avoid interference. Therefore, the port number for each device must be changed and this same number must be entered into the device configuration of the chromatography software. We recommend to use the same port number for all devices in the same system.



**Note:** The port is set to 10001 at the factory. You must use the same numbers in the device configuration of the chromatography software as in the device, otherwise the connection fails.

- Process**
1. Find out port number and change it on the device.
  2. Enter the port number in the chromatography software.

**Result** The connection is established.



**Note:** If the LAN cable has been connected and the connection is valid, the LED on the LAN port on the rear side lights up in green. The second LED blinks yellow during data transfer.

**Software** The pH monitor is embedded in the software packages ClarityChrom® and PurityChrom®.

## 4.4 Setting IP addresses via software



**Note:** Check the IT security standards for your lab before intervening in the LAN settings.

### PurityChrom®

Static IP addresses are required to run certain chromatography software, e.g. Purity Chrom®. For a comprehensive overview on how to set static IP addresses for PurityChrom®, refer to the document „PurityChrom® Installation Guide“ on the PurityChrom® installation CD.

For Firmware Wizard, it is possible to set a fixed (static) or dynamic (DHCP) IP address via software.

### 4.4.1 Firmware Wizard: Setting a static IP address



**Note:** More information about LAN settings can be found in the Mobile Control Software Instructions in the chapter “Firmware Wizard” (document no. V6851).

#### Legend:

- ① Text box for MAC address of the device
- ② Setting IP address manually
- ③ Text box for IP address
- ④ Text box for subnet mask & gateway
- ⑤ Confirm changes

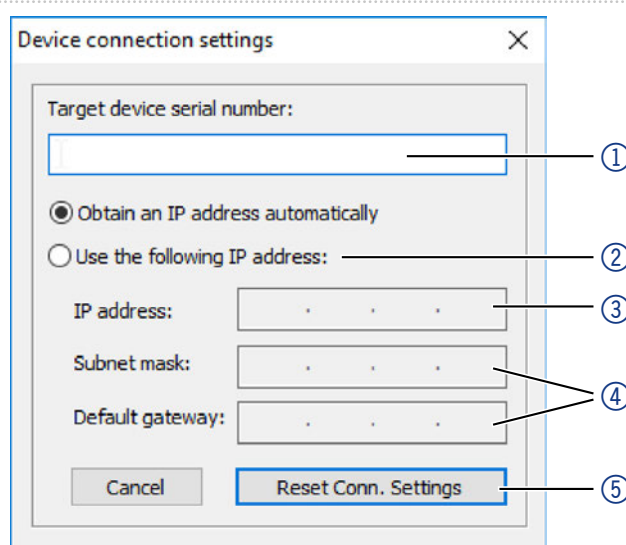

**Fig. 8:** Network settings in Firmware Wizard

#### Prerequisites

- The device is switched on.
- The device is set to LAN-DHCP (see chapter 5.3)
- Firmware Wizard is installed and running.
- The connection between Firmware Wizard and the device has been established.

#### Process

#### Procedure

1. In Firmware Wizard, click <Reset LAN Settings...>.
2. The window <Device connection settings> opens. Enter MAC address of the device into the text field <Target device serial number> ①.
3. Select option <Use the following IP address> ②.
4. Enter the IP address into the text field <IP address> ③.
5. Optionally, adjust subnet mask and gateway ④.

**Process**

6. Click <Reset Conn. Settings> ⑤ to accept changes.
7. Restart the device (recommended).

**Result** The device is now accessible via the static IP address.

#### 4.4.2 Firmware Wizard: Setting a dynamic IP address

- Prerequisites**
- The device is switched on.
  - Firmware Wizard is installed and running.

**Process****Procedure**

1. In Firmware Wizard, click <Reset LAN Settings...>.
2. The window <Device connection settings> opens. Enter MAC address of the device into the text field <Target device serial number> ①.
3. Select option <Obtain an IP address automatically> ②.
4. Click <Reset Conn. Settings> ⑤ to accept changes.
5. Restart the device (recommended).

**Result** The device is now accessible via a dynamic IP address.

### 4.5 Power connection

The devices are equipped with an universal switched-mode power supply rated for 100-240 V AC. The switched-mode power supply automatically selects the correct supply voltage.

- Supply voltage:  $115 \pm 15\%$  or  $230 \pm 10\%$  VACs
- Frequency: 50/60 Hz

**Legend:**

- ① On/Off switch
- ② LED



**Fig. 9:** Mains power connection

#### **⚠ DANGER**

**Electric shock**

Electric shock hazard caused by an improperly grounded power connection.

- ➔ Ground the power connection according to the pertinent regulations.
- ➔ Use a three-conductor line cord.

**Process**

1. Set the on/off switch ① to the OFF position
2. Connect the power supply to the device and afterwards plug the power plug into the socket.

**Figure**

**Next steps** Set the on/off switch to the ON position and start up the device.

## 5. Operation

The device is operated via the membrane keypad. The measurement can be followed via software, (e.g. PurityChrom® or ClarityChrom®) on the display.

### 5.1 Initial start-up

In case the monitor is part of a FPLC/HPLC system, check for the following criteria:

- A connection to the computer via the desired interface has been established (see chapter Note on page 13).
- The software has been installed.
- The pH sensor has been installed.

### 5.2 Switch on

#### Prerequisites

- The device has been installed at a suitable site.
- The device has been connected to power mains connection.
- The installation has been completed.

#### Process

1. Set the on/off switch ① to the ON position.

#### Figure



**Result** The display lights up and the green LED on the power supply indicates that the device is supplied with power.

#### 5.2.1 Operating elements

##### Display and keypad

Gradient 000 07.2 pH

**Fig. 10:** Status display



**Fig. 11:** Arrow keys





##### Explanation

The status display shows the pH value (line 2, right).

- Press both arrow keys simultaneously to activate the keypad.
- Hold down 1 arrow key to scroll with the other arrow key through the menu.
- Press any one of the arrow keys to set values and to change settings.



### 5.2.2 Menu items and factory settings

Display content	Description
 	Two menus help to calibrate the pH sensor: <ul style="list-style-type: none"> <li>▪ #0 is preset to pH07</li> <li>▪ #1 can be adjusted to a value between pH02 - pH12 and corresponds to the pH value of the second calibration solution that is used.</li> </ul>
	Select this menu to view the serial number of the monitor.
	Select this menu to view the operating hours of the pH monitor.
	Use this menu to select an interface for the PC connection: <ul style="list-style-type: none"> <li>▪ LAN DHCP</li> <li>▪ 9600 Baud (RS-232)</li> </ul>

### 5.3 Selecting the interface

To view the measuring results of the pH monitor via a software, the interface you use must be selected on the device:

- PC: LAN DHCP
- PC: 9600 Baud (RS-232)

- Prerequisites**
- A physical connection has been established.
  - The monitor has been switched on.

Process	Display
<ol style="list-style-type: none"> <li>1. Press both arrow keys.</li> <li>2. Hold down the left arrow key and use the right arrow key to scroll until the correct display appears.</li> <li>3. Let go of the arrow keys and press the left or right arrow key to select an option.</li> </ol>	

- Next steps** Check if the pH monitor appears in the software.

## 5.4 Checking the operating hours

The operating hours of the monitor can be viewed in the GLP menu, which displays the value in hours according to GLP specifications.

**Prerequisites** The monitor has been switched on.

Process	Display
<ol style="list-style-type: none"> <li>1. Press both arrow keys.</li> <li>2. Hold down the left arrow key and use the right arrow key to scroll until the correct display appears.</li> <li>3. Let go of the arrow keys.</li> </ol>	

**Next steps** Enter additional settings or start the analysis.

## 5.5 Calibrating the pH electrode

To calibrate the pH electrode for initial start-up, you use the preset value of pH 7 and a second value according to the calibration solution in use (e. g. 4, 10). Please pay attention to the indicated measuring values in mV to control the correct pH values in the second line of the monitor display. Benchmark values can be taken from the succeeding table.

pH	Measuring value	pH	Measuring value
2	+300	8	-60
3	+240	9	-120
4	+180	10	-180
5	+120	11	-240
6	+60	12	-300
7	±0		

**Prerequisites** The monitor has been switched on.

- The AZURA® pH electrode is connected to the AZURA® pH 2.1S via the BNC connection.

- Procedure**
1. Remove the AZURA® pH electrode from the AZURA® pH flow cell.
  2. Thoroughly rinse the AZURA® pH electrode with water and carefully pat dry with a lint-free cloth.
  3. Immerse the AZURA® pH electrode in a pH-7 calibration solution and then calibrate it according to the process (see table 1).
  4. Thoroughly rinse the AZURA® pH electrode with water and carefully pat dry with a lint-free cloth.
  5. Immerse the AZURA® pH electrode in calibration solution with a pH value of your choice and then calibrate it according to the process (see table 2).
  6. Rinse the AZURA® pH electrode with water.

7. Re-integrate the calibrated AZURA® pH electrode into the AZURA® pH flow cell.
8. Flush the AZURA® pH sensor with solvent compatible for the AZURA® pH electrode immediately after to prevent damaging the AZURA® pH electrode.

Table 1







Process	Display
<ol style="list-style-type: none"> <li>1. Press both arrow keys.</li> <li>2. Hold down the left arrow key and use the right arrow key to scroll until the correct display appears.</li> <li>3. Release the arrow keys and press the left or right arrow key to switch ON.</li> <li>4. Release the arrow keys and wait until the display shows the measured value.</li> </ol>	 
<ol style="list-style-type: none"> <li>5. Keep waiting until the value stabilizes (see table "Benchmark values" on page 21).</li> <li>6. Press any key.</li> <li>7. Press the right arrow key to save the result or the left arrow key to cancel.</li> </ol>	

Table 2

Process	Display
<ol style="list-style-type: none"> <li>1. Press both arrow keys.</li> <li>2. Hold down the left arrow key and use the right arrow key to scroll until the correct display appears.</li> <li>3. Release the arrow keys and press the left or right arrow key to select a value.</li> <li>4. Wait until the status display shows.</li> </ol>	
<ol style="list-style-type: none"> <li>5. Press both arrow keys.</li> <li>6. Hold down the left arrow key and use the right arrow key to scroll until the correct display appears.</li> <li>7. Hold down the left arrow key and use the right arrow key to switch to ON.</li> <li>8. Release the arrow keys and wait until the display shows the measuring value.</li> </ol>	
<ol style="list-style-type: none"> <li>9. Keep waiting until the value stabilizes (see table "Benchmark values" on page 21).</li> <li>10. Press any key.</li> </ol>	
<ol style="list-style-type: none"> <li>11. Press the right arrow key to save the result or the left arrow key to cancel.</li> </ol>	

**Next steps** Enter additional settings or start the analysis.

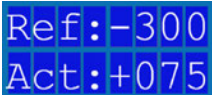
## 5.6 Switching off device

Remove the pH electrode - if installed - before using salt-free solvents for rinsing. For this purpose, utilize the bypass of the AZURA® pH flow cell or the AZURA® pH dummy electrode to maintain system flow after removing the AZURA® pH electrode and store it according to chap. 9.3.2.



**Note:** Alternatively, the system can continue to be operated with buffer at a low flow rate (e.g. 0.1 ml/min) until the next use.

If the device is to be switched off and stored, observe the instructions in chapter "9. Transportation and storage" on page 29.

### Process

1. Set the on/off switch on the power supply to the OFF ① position.

### Figure



**Result** The display and the LED on the power supply go off.

**Next steps** Disconnect the power supply from the mains power connection.

## 6. Functionality tests



**Note:** Standard processes regarding IQ and OQ in single devices may be handled differently in individual cases.

### 6.1 Installation Qualification (IQ)

The customer may request the Installation Qualification, which is free of charge. In case of a request, the technical support of KNAUER or a provider authorized by KNAUER performs this functionality test during the installation.

The Installation Qualification is a standardized document that includes the following:

- confirmation of flawless condition at delivery
- check if the delivery is complete
- certification on the functionality of the device

You can either use the IQ document attached to this instruction manual or download a digital version from our website:



### 6.2 Operation Qualification (OQ)

The Operation Qualification includes an extensive functionality test according to KNAUER standard OQ documents. The Operation Qualification is a standardized document and free of charge. It is not part of the delivery. Please contact the technical support in case of a request.

The Operation Qualification includes the following:

- definition of customer requirements and acceptance terms
- documentation on device specifications
- device functionality check at installation site

**Test Intervals** To make sure that the device operates within the specified range, you should test the device regularly. The test intervals depend on the usage of the device.

**Execution** The test can be carried out either by the technical support of KNAUER or by a provider authorized by KNAUER (for a fee). For further information visit our website:



## 7. Troubleshooting

If the device stops functioning or there are connection problems, start by checking the following items:

- Does the display light up?
- Are the LEDs on the LAN port turned on?  
When you connect the cable, the green LED goes on. The second LED blinks yellow during data transfer.
- Is the LED of the power supply on?

### 7.1 LAN

Go through the following steps, in case no connection between the computer and the devices can be established. Check after each step if the problem is solved. If the problem cannot be located, call the technical support.

1. Check the status of the LAN connection in the Windows task bar:



If no connection was established, test the following:

- Is the router/switch switched on?
  - Is the patch cable connected correctly to the router and the computer?
2. Check the Router/switch settings:
    - a) if the router is set to a DHCP server:
      - Is the IP address range sufficient for all the connected devices?
    - b) if a switch is used with fixed IP address:
      - Is the IP address/Subnetmask and standard gateway of the device set correctly?
  3. Check all connections:
    - Are the patch cables connected to the LAN ports and not the WAN port?
    - Are all cable connections between devices and router correct?
    - Are the cables plugged in tightly?
  4. If the router is integrated into a company network, pull out the patch cable from the WAN port.
    - Can the devices communicate with the computer, even though the router is disconnected from the company network?
  5. Turn off all devices, router, and computer. Firstly, turn on the router and secondly turn on the devices and the computer.
    - Has this been successful?
  6. Replace the patch cable to the device with that no connection could be established.
    - Has this been successful?
  7. Make sure that the IP port of the device matches the port in the chromatography software.

## 7.2 Possible problems and solutions

	Problem	Solution
pH value	Noisy or unstable readings	<ul style="list-style-type: none"><li>■ If necessary, remove air bubble on the membrane of the pH flow cell.</li></ul>
	Drift solution temperature is changing	<ul style="list-style-type: none"><li>■ Allow all solutions to come to thermal equilibrium.</li></ul>
	Leakage around pH probe	<ul style="list-style-type: none"><li>■ Tighten pH electrode nut.</li><li>■ Replace o-rings.</li></ul>
	Leakage around fittings	<ul style="list-style-type: none"><li>■ Tighten fitting.</li><li>■ Replace fitting.</li></ul>

## 8. Maintenance and care

Proper maintenance of your devices will ensure successful analyses and reproducible results.

### 8.1 Maintenance contract

The following maintenance work on the device may only be performed by the manufacturer or a company authorized by the manufacturer and is covered by a separate maintenance contract:

- Opening the module.
- Removing the hood or the side panels.

### 8.2 Cleaning the device

- Prerequisites**
- The monitor has been switched off.
  - The power plug has been pulled.

#### NOTICE

##### Device defect

Intruding liquids can cause damage to the device.

- Place solvent bottles next to the device or in a solvent tray.
- Moisten the cleaning cloth only slightly.

Clean all smooth surfaces of the device with a wet cloth and a mild commercially available cleaning solution or isopropanol.



**Note:** Observe the storage recommendations for the wetted parts in chapter 9.1.

### 8.3 Flushing and cleaning the pH sensor



**Note:** The pH electrode has a limited lifetime and should be replaced every 6 months.



**Note:** The pH flow cell and the pH electrode can be cleaned together (recommended), but can also be rinsed separately by hand. In the flow, the flow cell and electrode can only be cleaned together.

#### 8.3.1 Cleaning pH electrode

A dirty pH electrode can lead to erroneous pH readings, delayed measurement results and shorten the lifetime of the electrode. Most contaminants will be either proteins that have adsorbed onto the glass membrane or buffer and salt crystals that have blocked the pH probe pores.

**Removal of protein deposits:** Immerse the electrode in a 0.1 M HCl / 1% protease (e.g. trypsin or pepsin) solution for max. 5 minutes. Rinse with deionized water to remove all traces of HCl.



**Removal of salt deposits:** Immerse the electrode in 0.1 M HCl for 5 minutes followed by 0.1 M NaOH for 5 minutes and then 0.1 M HCl for 5 minutes. Rinse the electrode with deionized water to remove all traces of HCl.

### 8.3.2 Cleaning pH flow cell

If the pH flow cell is separated from the pH electrode, all chemicals suitable for PEEK surfaces can be used for manual cleaning. Cleaning in an ultrasonic bath is also possible.

**Next steps** Store the pH electrode or return it to the pH flow cell and flush it with suited buffer solution of the FPLC system. For storage, separate components and store according to storage recommendations.

## 8.4 Replacing pH electrode

If you wish to replace the pH electrode, proceed as follows:

- Prerequisites**
- The pH 2.1S has been switched off.
  - The power plug of the pH 2.1S has been pulled.
  - There is no more flow in the pH flow cell. If necessary, short-circuit the capillary connections via the bypass of the flow cell to prevent leakage or insert the AZURA® pH dummy electrode.

### Process

### Figure

1. Disconnect the BNC plug connection of the pH sensor to the pH monitor and, if necessary, provide connection with a BNC blind plug ①.

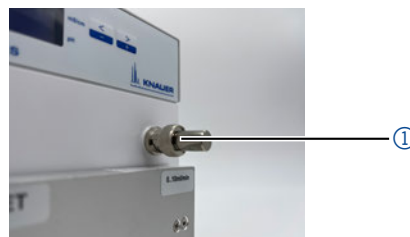

2. Loosen the cap nut ② and remove it from the pH electrode to be replaced.

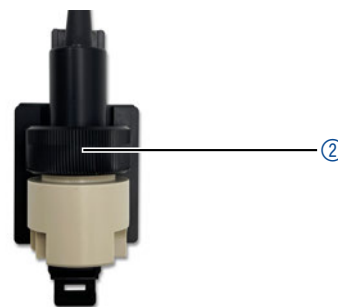

3. Remove the pH electrode.
4. Install and flush the new pH electrode according to chapter 4.2.2.

## 9. Transportation and storage

Carefully prepare the device for transport or storage. If you want to return your device to KNAUER for repairs, enclose the [Service request form](#) which can be downloaded from our website.

### 9.1 Preparing wetted components

pH flow cell and  
pH electrode

Flush the pH flow cell and pH electrode according to chapter 8.3.

### 9.2 Disassembling the device

#### 9.2.1 Disconnecting the power supply

**Prerequisites** The device has been switched off.

##### Process

1. Pull the plug out of the socket and afterwards remove the power supply from the device.
2. Package the power supply and store it nearby the device.

#### 9.2.2 Removing the pH sensor

**Prerequisites**

- The device has been switched off.
- The power plug has been pulled.

##### Process

1. Disconnect the BNC plug connection of the pH sensor to the pH monitor and insert the BNC blind plug ①.

##### Figure



2. Disconnect the capillaries and replace the pH flow cell with the coupling in the accessories kit of the pH sensor in the flow path of the system.
3. Detach the pH electrode from the pH flow cell and immerse it in a pH storage solution. The solution can be in a beaker or in the protective sleeve of the pH electrode.
4. Rinse the pH flow cell with water and store it dry.

## 9.3 Storing the device

### 9.3.1 Storage of the pH monitor

The functionality of the device remains warranted, if you select a storage location according to the following ambient conditions:

<b>Temperature range</b>	4 - 40 °C; 39.2 - 104 °F
<b>Air humidity</b>	Below 90%, non-condensing
<b>Air pressure</b>	84 - 106 kPa; 840 - 1060 mbar

### 9.3.2 Storage of the pH sensor

Store the pH electrode of the pH sensor in a pH storage solution as stated in the instructions of the electrode supplement. Classic pH storage solutions are commercially available and typically consist of pH 4 buffers in 3-4 M KCl.

Store the pH flow cell dry.

#### Process

1. Fill the protective sleeve of the pH electrode with KCl solution.
2. Insert the pH electrode into the protective sleeve.

---

## 10. Disposal

Hand in old devices or disassembled old components at a certified waste facility, where they will be disposed of properly.

### 10.1 AVV marking in Germany

According to the German „Abfallverzeichnisverordnung“ (AVV) (January, 2001), old devices manufactured by KNAUER are marked as waste electrical and electronic equipment: 160214.

### 10.2 WEEE registration

KNAUER as a company is registered by the WEEE number DE 34642789 in the German „Elektroaltgeräteregister“ (EAR). The number belongs to category 8 and 9, which, among others, comprise laboratory equipment.

All distributors and importers are responsible for the disposal of old devices, as defined by the WEEE directive. End-users can send their old devices manufactured by KNAUER back to the distributor, the importer, or the company free of charge, but would be charged for the disposal.

### 10.3 Solvents and other operating materials

All solvents and other operating materials must be collected separately and disposed of properly.

All wetted components of a device, e. g. flow cells of detectors or pump heads and pressure sensors for pumps, have to be flushed first with isopropanol and then with water before being maintained, disassembled or disposed.

## 11. Technical data

<b>Main features</b>	<b>Device type</b>	pH monitor
	<b>pH measurement range</b>	pH 0 - 14
	<b>pH accuracy</b>	pH 2 - 12: ±0.2 pH (15 - 25 °C), ±0.5 pH (4 - 40 °C)
	<b>pH drift</b>	Maximum 0.02 pH/h at pH 4
	<b>Maximum data rate</b>	5 Hz (LAN, RS-232)
	<b>Outputs</b>	LAN, RS-232
	<b>Control</b>	Manual: Keypad
	<b>Protection class</b>	IP 20
	<b>Weight</b>	3.2 kg
	<b>Dimensions</b>	121 x 129 x 187 mm (W x H x D)
<b>Permitted ambient conditions</b>	<b>Power supply</b>	100 - 240 V, 50 - 60 Hz, max. 20 W
	<b>Area of use</b>	Indoor use only
	<b>Ambient temperature</b>	4-40 °C (39.2 - 104 °F)
	<b>Relative humidity</b>	Less than 90%, non-condensing
	<b>Operating altitude</b>	Max. 2000 meters above sea level
	<b>Permissible pollution degree</b>	2
	<b>Overvoltage category</b>	II
	<b>Permissible mains voltage fluctuations</b>	±10 %

## 12. Chemical compatibility of wetted materials



**Note:** The user takes the responsibility for using the fluids and chemicals in an appropriate and safe way. If there is any doubt, contact the technical support of the manufacturer.

### 12.1 General

The device is very resistant against a variety of commonly used eluents. However, make sure that no eluents or water come in contact with the device or enter into the device. Some organic solvents (such as chlorinated hydrocarbons, ether) may cause coating damage or loosen glued components by improper handling. Even small quantities of other substances, such as additives, modifiers, or salts can influence the durability of the materials. Exposure time and concentration have a high impact on the resistance.

The following list contains information about the chemical compatibility of all wetted materials which are used in devices made by KNAUER. The data bases on a literature research on the manufacturer specifications of the materials. The wetted materials of this device are listed in the chapter "Technical data".

All resistances mentioned here are for use at temperatures up to 40 °C, unless stated otherwise. Please note that higher temperatures can significantly affect the stability of different materials.

### 12.2 Plastics

#### Polyetheretherketone (PEEK)

PEEK is a durable and resistant plastic and, next to stainless steel, the standard material in HPLC. It can be used at temperatures up to 100 °C and is highly chemical resistant against almost all commonly used solvents in a pH range of 1-12.5. PEEK is potentially moderate resistant against oxidizing and reducing solvents.

Therefore, following solvents should not be used: Concentrated and oxidizing acids (such as nitric acid solution, sulfuric acid), halogenated acids (such as hydrofluoric acid, hydrobromic acid) and gaseous halogens. Hydrochloric acid is approved for most applications.

In addition, following solvents can have a swelling effect and may have an impact on the functionality of the built-in components: Methylene chloride, THF and DMSO in any concentration such as acetonitrile in higher concentrations.

#### Polyethylene terephthalate (PET, outdated PETP)

PET is a thermoplastic and semi-crystalline material with high wear resistance. It is resistant against diluted acids, aliphatic and aromatic hydrocarbons, oils, fats and alcohols, but not against halogenated hydrocarbons and ketones. Since PET belongs chemically to esters, it is not compatible with inorganic acids, hot water and alkalis. Maximum operating Temperature: up to 120 °C.

**Polyimide (Vespel®)**

This material is wear-resistant and permanent resilient thermally (up to 200 °C) as well as mechanically. It is chemically broadly inert (pH range 1-10) and is especially resistant against acidic to neutral and organic solvents, but vulnerable to pH strong chemical or oxidizing environments: It is incompatible with concentrated mineral acids (such as sulfuric acid), glacial acetic acid, DMSO and THF. In addition, it will be disintegrated by nucleophilic substances like ammonia (such as ammonium salts under alkaline conditions) or acetate.

**Ethylene-tetrafluorethylene copolymer (ETFC, Tefzel®)**

This fluorinated polymer is highly resistant against neutral and alkaline solvents. Some chlorinated chemicals in connection with this material should be handled with care. Maximum operating Temperature is 80 °C.

**Perfluorethylenpropylen-Copolymer (FEP), Perfluoralkoxy-Polymer (PFA)**

These fluorinated polymers hold similar features as PTFE, but with a lower operation temperature (up to 205 °C). PFA is suitable for ultrapure applications, FEP can be used universally. They are resistant against almost all organic and inorganic chemicals, except elemental fluorine under pressure or at high temperatures and fluorine-halogen compounds.

**Polyoxymethylene (POM, POM-HTF)**

POM is a semi-crystalline, high-molecular thermoplastic material which stands out due to its high stiffness, low friction value and thermic stability. It can even substitute metal in many cases. POM-HTF is a combination of PTFE fibres and acetal resin and is softer and has better slip properties as POM. The material is resistant against diluted acids (pH > 4) as well as diluted lyes, aliphatic, aromatic and halogenated hydrocarbons, oils and alcohols. It is not compatible with concentrated acids, hydrofluoric acid and oxidizing agent. Maximum operating Temperature is 100 °C.

**Polyphenylene sulfide (PPS)**

PPS is a soft polymer which is known for its high break resistance and very high chemical compatibility. It can be used with most organic, pH neutral to pH high, and aqueous solvents at room temperature without concerns. However, it is not recommended for using with chlorinated, oxidizing and reducing solvents, inorganic acids or at higher temperatures. Maximum operating temperature: 50 °C.

**Polytetrafluorethylene (PTFE, Teflon®)**

PTFE is very soft and anti-adhesive. This material is resistant against almost all acids, lyes and solvents, except against fluid sodium and fluoride compounds. In addition, it is temperature-resistant from -200 °C to +260 °C.

**Systec AF™**

This amorphous perfluorinated copolymer is inert against all commonly used solvents. However, it is soluble in perfluorinated solvents like Fluorinert® FC-75 and FC-40, and Fomblin perfluoropolyether solvents from Ausimont. In addition, it is affected by Freon® solvents.

**Polychlorotrifluoroethylene (PCTFE, Kel-F®)**

The semi-crystalline thermoplastic material is plasticizer-free and dimensionally stable, even in a wide temperature range (-240 °C to +205 °C). It is moderately resistant against ether, halogenated solvents and toluene. Halogenated solvents over +60 °C and chlorine gas should not be used.

**Fluorinated rubber (FKM)**

The elastomer consisting of fluorinated hydrocarbon stands out due to a high resistance against mineral oils, synthetic hydraulic fluids, fuels, aromatics, and many organic solvents and chemicals. However, it is not compatible with strong alkaline solvents (pH value >13) like ammonia, and acidic solvents (pH value <1), pyrrole and THF. Operating temperature: Between -40 °C and +200 °C.

**Perfluorinated rubber (FFKM)**

This perfluoro elastomer has a higher fluorine content as fluorinated rubber and is therefore chemically more resistant. It can be employed at higher temperatures (up to 275 °C). It is not compatible with Pyrrole.

## 12.3 Non-metals

**Diamond-like carbon (DLC)**

This material is characterized by a high hardness, a low coefficient of friction and thus low wear. In addition, it is highly biocompatible. DLC is inert against all acids, alkalis and solvents commonly used in HPLC.

**Ceramic**

Ceramic is resistant against corrosion and wear and is fully biocompatible. An incompatibility against acids, alkalis and solvents commonly used in HPLC is not known.

**Alumina (Al<sub>2</sub>O<sub>3</sub>)**

Due to their high resistance to wear and corrosion, alumina ceramic is used as a coating for mechanically stressed surfaces. It is a biocompatible material with low thermal conductivity and low thermal expansion.

**Zirconium oxide (ZrO<sub>2</sub>)**

Zirconia ceramics are characterized by their high mechanical resistance, which makes them particularly resistant to wear and corrosion. It is also biocompatible, has low thermal conductivity and is resistant to high pressures.

**Sapphire**

Synthetic sapphire is virtually pure monocrystalline alumina. It is biocompatible and very resistant to corrosion and wear. The material is characterized by a high hardness and a high thermal conductivity.

**Ruby**

Synthetic ruby is monocrystalline alumina and gets its red color by the addition of some chromium oxide. It is biocompatible and very resistant



to corrosion and wear. The material is characterized by a high hardness and a high thermal conductivity.

#### **Mineral wool**

This insulating material consists of glass or stone wool fibres and isolates in high oxidizing conditions and at high temperatures. Mineral wool is valid as commonly inert against organic solvents and acids.

#### **Glass, glass fibre, quartz, quartz glass**

These mineral materials are resistant against corrosion and wear and are mostly chemical inert. They are compatible with oils, fats and solvents and show a high resistance against acids and lyes up to pH values of 3-9. Concentrated acids (especially hydrofluoric acid) may embrittle and corrode the minerals. Lyes may ablate the surfaces slowly.

## **12.4 Metals**

#### **Stainless steel**

Stainless steel is, apart from PEEK, the standard material in HPLC. Steels with WNr. 1.4404 (316L) are used, or with a mixture of higher compatibility.

They are inert against almost all solvents. Exceptions are biological applications which are metal ion sensible, and applications with extreme corrosive conditions. These steels, in comparison to commonly used steels, are increasingly resistant against hydrochloric acid, cyanides and other halogen acids, chlorides and chlorinated solvents.

The use in ion chromatography is not recommended. In case of electrochemical applications, a passivation must be executed first.

#### **Hastelloy®-C**

This nickel-chrome-molybdenum alloy is extremely resistant to corrosion, especially against oxidizing, reducing and mixed solvents, even at high temperatures. This alloy may be used in combination with chlor, formic acid, acetic acid and saline solutions.

#### **Titanium, titanium alloy (TiA16V4)**

Titanium has a low weight and a high hardness and stability. It stands out due to its very high chemical compatibility and biocompatibility. Titan is applied when neither stainless steel nor PEEK are usable.

## 13. Repeat orders

This list for reorders is valid for the time the document has been published. Deviations afterwards are possible.

For reorders of spare parts use the enclosed packing list. Contact the [technical support](#) in case there are any questions on spare parts or accessories.

### Ready-to-measure device

Name	Order number
AZURA® pH 2.1S	ADG31

### pH monitoring

Name	Order number
AZURA® pH sensor for flow rates up to 100 ml/min delay volume ~ 80 µl, max. pressure 5 bar	A70091-2
AZURA® pH sensor, 1000 ml/min	A70091-3
AZURA® pH electrode for AZURA® pH sensor	A1933-1
AZURA® pH flow cell, up to 100 ml/min	A1943
AZURA® pH flow cell, over 100 ml/min	A1946
AZURA® pH dummy electrode for AZURA pH sensor	A1942-1

### Mounting accessories



Name	Order number
Mounting bracket for attaching AZURA® pH 2.1S to AZURA L devices	A9854-3
AZURA® Organizer	A70085
AZURA® Click	A70089

### Fluidic connection accessories

Name	Order number
1/16"-1/16" coupling incl. unions and fittings	A0148
1/8"-1/16" reducer incl. one-piece fittings	A1407
One-piece fingertight PEEK bushings with knurled head, integrated sealing cone for 1/8" (5 pcs.)	A1406

## **Appendix: Installation Qualification (IQ)**

## Installation Qualification (IQ) for a Device

	Created	Reviewed	Approved
Function	Technical editor	Engineering	Head of Quality
Name	Anna Erben	Paul Pietsch	Kate Monks
Date	23/08/2022	29/08/2022	30/08/2022
Signature	 <small>Digital unterschrieben von Anna Erben Datum: 2022.08.23 14:09:27 +02'00'</small>		

### 0. Customer approval

Prior to installation at the customer site, the customer has reviewed the OQ document and agrees with the design and scope

Company name:

Name	Function	Reviewed & approved	Date	Signature

## Installation Qualification (IQ) for a Device

### 1. Definition of the Installation Qualification

The qualification document „Installation Qualification (IQ)“ is part of the quality management system at the company KNAUER Wissenschaftliche Geräte GmbH.

### 2. Scope

The customer can request the Installation Qualification. In case of a request, the technical support of KNAUER or a provider authorized by KNAUER performs this functionality test during the installation. The IQ is a standardized document and includes the following:

- Confirmation of flawless condition at delivery
- Check if the delivery is complete
- Certification on the functionality of the device

### 3. Instructions

All deviations from the specifications that occurred during installation have to be recorded in this document.

In addition, all measures taken to eliminate the deviations have to be noted down as comments in the list of rectifications (LOR) on page 4.

If certain items in the report are not applicable, this has to be indicated in the table as „N/A“ (not applicable). Major sections that are not used have to be crossed out (diagonal line), marked „N/A“, dated and signed.

All required documents have to be completed by the end of the installation. The document has to be reviewed and approved by an authorized person. The review and approval have to be documented with signature and date (DD/MM/YYYY).

The tests have to be carried out in a suitable environment, as described in the user instruction of the device.

### 4. About this document

The information in this document is subject to change without prior notice. This document may not be used, reproduced or translated without written consent of KNAUER Wissenschaftliche Geräte GmbH. Depending on the customer's quality assurance system, the signed document either has to be filed in the device folder or scanned and stored in an electronic archive.

### 5. Device data

Device name		Product number	
Serial number		Order number	
Firmware version			
Installation location			

### 6. Customer and manufacturer data

	Customer	Manufacturer
Company		KNAUER Wissenschaftliche Geräte GmbH
Customer number		-
Contact person/agent		
Address		Hegauer Weg 38
Postal Code/City		14163 Berlin
Phone		+49 30 80 97 27 111
E-Mail		support@knauer.net

## Installation Qualification (IQ) for a Device

### 7. Installation Qualification Tests

Test	Description	Specification	Passed	Failed	N/A	Comment/LOR No.
1	Identify the device.	The name on the device matches the name on the delivery order.				
2	Check the device for transport damage.	No transport damage is observed.				
3	Check the scope of delivery.	The scope of delivery matches the packing list and/or the delivery order.				
4	Check that the technical documentation provided is correct and complete (material documentation of wetted parts, calibration certificates etc.)	The documentation is correct and complete.				
5	Check that all equipment is properly and correctly labeled according to the delivery order and/or the labeling specifications document, if applicable.	The equipment is labeled correctly.				
6	Connect all loose parts (e.g. capillaries, tubings, measuring head) according to the user instructions.	The device is fully assembled and ready to use.				
7	Ensure that the installation site is suitable according to the user instructions.	The installation site matches the specifications in the user instructions.				
8	Connect the device to the power supply and switch it on.	The device starts (operating noise). The power LED or the display lights up.				

## Installation Qualification (IQ) for a Device

### 8. List of rectifications (LOR)

LOR No.	Test No.	Type of deviation*	Description of the deviation	Action plan	Persons responsible	Due date	Date/signature

\*Type of deviation:

A = acceptable (e.g. not a GMP-critical deviation)

N = not acceptable

Continuation of qualification activities into the next qualification phase is only possible when deviation is rectified.

T = temporarily acceptable

a) Release and use of the system is possible, even when the deviation is not rectified.

b) A continuation of qualification activities into the next qualification phase is possible, even when the deviation is not rectified

## Installation Qualification (IQ) for a Device

### 9. List of changes to the document

Revision no.	Description of change	Additional information	Date/signature



## Installation Qualification (IQ) for a Device

### 10. Certificate and approval

A KNAUER employee or an employee authorized by KNAUER has checked the device and performed all tests described in the IQ.

The IQ form has to be signed by an authorized person. The scope of the IQ meets the customer’s requirements.

The results of the IQ, any changes made as well as the IQ process have been documented in this form in writing. The users listed below were instructed and are familiar with how to operate the device. Both parties confirm that the IQ has been performed to the customer’s satisfaction by signing it.

#### 10.1 Customer approval

Name	Function	Date	Signature

#### 10.2 KNAUER agent approval

Name	Function	Date	Signature

### 11. Comments / recommendations

---



---



---



Science with Passion



Latest KNAUER instructions online:  
[www.knauer.net/library](http://www.knauer.net/library)

**KNAUER**  
Wissenschaftliche Geräte GmbH  
Hegauer Weg 38  
14163 Berlin

Phone: +49 30 809727-0  
Fax: +49 30 8015010  
E-mail: [info@knauer.net](mailto:info@knauer.net)  
Internet: [www.knauer.net](http://www.knauer.net)