

Science with Passion

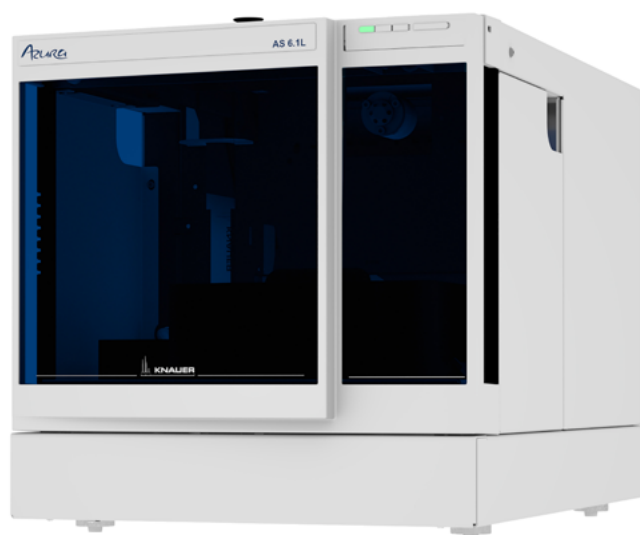

Azure

Autosampler AS 6.1L Instructions



Document No. V6821

HPLC



Note: For your own safety, read the instructions and follow the warnings and safety information on the device and in the instructions. Keep the instructions for future reference.



Note: In case you require this instruction in another language, please submit your request including the corresponding document number via e-mail or fax to KNAUER.

Support: Do you have questions about the installation or the operation of your instrument or software?

International Support:

Contact your local KNAUER partner for support:

www.knauer.net/en/Support/Distributors-worldwide

Support in Germany

(Austria & Switzerland on case-to-case basis):

Phone: +49 30 809727-111 (workdays 9-17h CET)

Fax: +49 30 8015010

E-mail: support@knauer.net

Publisher: KNAUER Wissenschaftliche Geräte GmbH

Hegauer Weg 38

14163 Berlin

Germany

Phone: +49 30 809727-0

Fax: +49 30 8015010

Internet: www.knauer.net

E-mail: info@knauer.net

Version information: Document number: V6821

Version number: 2.13

Release date: March 27, 2024

Original edition

The information in this document is subject to change without prior notice. For the latest version of the instructions, visit our website: www.knauer.net/en/Support/Library.



Copyright: This document contains confidential information and may not be reproduced without written consent of KNAUER Wissenschaftliche Geräte GmbH.

© KNAUER Wissenschaftliche Geräte GmbH 2024

All rights reserved.

AZURA® is a registered trademark of KNAUER Wissenschaftliche Geräte GmbH.

Table of contents

1. General	1
1.1 About these instructions	1
1.2 Signal words	1
1.3 Additional typographical conventions	1
1.4 Legal information	2
1.4.1 Liability limitation	2
1.4.2 Transport damage	2
1.4.3 Warranty conditions	2
1.4.4 Warranty seal	2
1.4.5 Declaration of conformity	2
2. Basic safety instructions	3
2.1 Intended use	3
2.1.1 Operating ranges	3
2.1.2 Foreseeable misuse	3
2.2 User qualification	3
2.3 Operator responsibility	4
2.4 Personal safety equipment	4
2.5 Safety features on the device	4
2.6 Working with solvents	5
2.6.1 General requirements	5
2.6.2 Contamination by health-threatening solvents	5
2.6.3 Avoiding leakage	5
2.7 Specific environments	6
2.7.1 Earthquake-endangered areas	6
2.7.2 Explosive environment	6
2.7.3 Cooling room	6
2.7.4 Wet room	6
2.8 Maintenance, care and repair	6
2.9 Service request form and decontamination report	7
3. Product information	8
3.1 Intended use	8
3.2 Performance features	8
3.3 Device versions	9
3.4 Views	9
3.4.1 Front view	9
3.4.2 Rear view	10
3.5 Scope of delivery	11
3.6 Symbols and signs	12

4. Installation and initial startup	14
4.1 Unpacking	14
4.2 Ambient conditions	14
4.2.1 Operation site	14
4.2.2 Ambient temperature	14
4.2.3 Space requirements	15
4.3 Power supply	15
4.4 Leak management	16
4.5 Computer control	17
4.5.1 Setting up LAN	17
4.5.2 Configuring LAN settings	17
4.5.3 Connecting devices with LAN	18
4.5.4 Configuring the router	18
4.5.5 Integrating LAN into the company network	19
4.5.6 Controlling several systems separately in LAN	19
4.5.7 APIPA	20
5. Operation	21
5.1 Inserting the sample vials	21
5.1.1 Removing the front cover and the side parts	21
5.1.2 Removing the cooler cover	22
6. Injection System	23
6.1 PASA™ Loop injection	23
6.2 ILD™ for analytical autosamplers	23
6.3 Injection principles	24
6.3.1 Full loop filling	26
6.3.2 Partial loop filling	28
6.3.3 µl pickup	31
6.3.4 µl pickup with 84+3 vial plate	33
7. 84+3 vial plate	35
7.1 Settings for the 84+3 vial plate	35
7.2 Details on programming	36
8. Air needles	37
8.1 Standard air needle	37
8.2 Choosing the correct air needle	38
8.3 Handling the sample vials	40
9. Mix & Dilute	41
9.1 Example: Add	41
9.2 Example: Mix	42
9.3 Sample positions in mixing routine	42
9.3.1 Processing in columns	42
9.3.2 Processing in rows	43
9.4 Parameters for mixing method with 84+3 vial plate	43
9.4.1 Details on programming the 84+3 mixing method	44

10. Connecting capillary and tubing	45
10.1 Valve connections	45
10.2 Syringe connections	45
10.2.1 Tubing guide for flushing solution	46
10.3 Connecting the waste	46
11. Connecting the autosampler to other devices	47
11.1 Controlling the autosampler with chromatography software	47
11.1.1 Checking and configuring the parameters of the autosampler	47
11.1.2 Configuration window of ClarityChrom®	47
11.2 Autosampler device software	47
11.3 Flushing the system	48
11.3.1 System flushing with Autosampler AS 6.1L Service Manager	48
11.4 I/O connection	48
11.4.1 Defining the TTL inputs	48
11.4.2 Defining the closed-contact output	49
11.4.3 Configuration of I/O connection (9 pins)	49
12. Functionality tests	50
12.1 Installation Qualification (IQ)	50
12.2 Operation Qualification (OQ)	50
13. Maintenance and care	51
13.1 Maintenance contract	51
13.2 Which type of maintenance tasks may users perform on the device?	51
13.3 System flushing	52
13.4 Exchanging the fuses	52
13.5 Exchanging the injection valve and rotor seal	52
13.5.1 Removing the injection valve and rotor seal	52
13.6 Replacing the sample loop	54
13.7 Exchanging the sample needle	54
13.8 Exchanging the air needle	55
13.9 Change of the syringe	56
13.9.1 Exchanging the syringe plunger or plunger tip	57
13.10 Syringe valve replacement	57
13.11 Replacing the buffer tubing	59
13.12 Replacing the wash port	60
13.13 Cleaning and caring for the device	62
13.14 Putting the instrument out of operation	62

14. Troubleshooting	63
14.1 Device errors	63
14.1.1 Checking the valve	63
14.2 LAN	63
14.3 Analytical errors	64
14.4 System messages in OpenLAB®	66
15. Technical data	75
15.1 Main features	75
15.2 Device variants	75
15.3 Communication	76
15.4 General	76
16. Repeat orders	77
17. Transport and storage	79
17.1 Taking the device out of operation	79
17.2 Packing the device	79
17.3 Transporting the device	79
17.4 Storing the device	79
18. Disposal	80
18.1 AVV-Marking Germany	80
18.2 WEEE registration number	80
18.3 Eluents and other operating materials	80
19. Chemical compatibility of wetted materials	81
19.1 General	81
19.2 Plastics	81
19.3 Non-metals	83
19.4 Metals	84

1. General

1.1 About these instructions

These operating instructions enable the safe and efficient operation of the device. The user must have read and understood these operating instructions before starting any work.





The basic prerequisite for safe operation is compliance with all safety instructions (see chapter 2 on page 3). In addition to the safety and warning instructions in these operating instructions, the local accident prevention regulations and the national industrial safety regulations apply.

These operating instructions are an integral part of the device. It has to be kept in the immediate vicinity of the device and accessible to the user at all times.

You can find these and other instructions on the KNAUER website: www.knauer.net/library

1.2 Signal words

Possible dangers related to the device are distinguished in personal and material damages.

Symbol	Meaning
	DANGER (red) indicates a highly hazardous situation. If not avoided, it will result in death or serious injury.
	WARNING (orange) indicates a hazardous situation. If not avoided, it could result in death or serious injury.
	CAUTION (yellow) indicates a moderate hazardous situation. If not avoided, it could result in minor or moderate injury.
	NOTICE (blue) is used to address issues which are not related to physical injury.

1.3 Additional typographical conventions

- General equal treatment: When persons are described, this document uses the male grammar form to keep the text easy to read. The form has a neutral sense and speaks to people of any gender in the same way.
- Note: Specific information are prefixed with the word "Note" and an information icon.

 **Note:** This is an example.

1.4 Legal information

1.4.1 Liability limitation

The manufacturer is not liable for the following issues:

- Non-compliance of these instructions
- Non-observance of necessary safety precautions
- Improper use
- Operation of the device by unqualified personnel (see chapter 2.2 on page 3)
- Use of non-approved spare parts
- Technical changes by the user such as opening the device and unauthorized modifications
- Violations of General Terms and Conditions (GTC)

1.4.2 Transport damage

The packaging of our devices provides the best possible protection against transport damage. However, check the packaging for transport damage. In case you notice any damage, inform the Technical Support and the shipping company within three workdays.

1.4.3 Warranty conditions

For information on warranty please refer to our general terms and conditions on the website: www.knauer.net/terms

1.4.4 Warranty seal

A blue or orange warranty seal is affixed to some devices.

- A blue seal is used by KNAUER's Manufacturing or Customer Support for devices to be sold.
- After repair, service technicians attach an orange seal onto the identical position.

After repair, the service technician affixes an orange seal in the same place. If unauthorised persons tamper with the device or if the seal is damaged, the warranty will lapse.



1.4.5 Declaration of conformity

The declaration of conformity is enclosed as a separate document with the product and can be obtained online:

www.knauer.net/en/Support/Declarations-of-conformity

2. Basic safety instructions

The device has been developed and constructed in such a way that hazards arising from its intended use are largely excluded. Nevertheless, the following safety instructions have to be observed in order to exclude residual hazards.

2.1 Intended use

Only use the device for applications that fall within the range of the intended use. Otherwise, the protective and safety equipment of the device could fail.

2.1.1 Operating ranges

The device is intended to be used for chromatographic applications in the laboratory.

2.1.2 Foreseeable misuse

Refrain from the use of the device for the following purposes or conditions:

- Medical purposes. The device is not approved as a medical product.
- Operating outside of a laboratory or measurement room. Otherwise, the manufacturer does not guarantee the functionality and safety of the device.
- Operation in potentially explosive areas without special and additional explosion protection. Contact the KNAUER Customer Support for more information.

2.2 User qualification

The user is qualified to handle the device if all of the following points apply:

- He has at least a basic knowledge of liquid chromatography.
- He has knowledge about the properties of the used solvents and their health risks.
- He is trained for the special tasks and activities in the laboratory and knows the relevant standards and regulations.
- Due to his technical training and experience, he can understand and carry out all the work described in the operating instructions on the instrument and recognize and avoid possible dangers independently.
- His ability to react is not impaired by the consumption of drugs, alcohol or medication.
- Participation in the installation of a device or a training by the company KNAUER or an authorized company.

If the user does not meet these qualifications, he has to inform his supervisor.

2.3 Operator responsibility

The operator is any person who operates the device himself or leaves it to a third party for use and who bears the legal product responsibility for the protection of the user or third parties during operation.

The obligations of the operator are listed below:

- Know and follow the applicable work safety regulations
- Identify hazards arising from the working conditions at the place of use in a risk assessment.
- Set up operating instructions for the operation of the device.
- Regularly check whether the operating instructions correspond to the current status of the regulations.
- Clearly regulate and specify responsibilities for installation, operation, troubleshooting, maintenance and cleaning and set clear rules
- Ensure that all personnel who work with the device have read and understood these operating instructions
- Train the personnel who work with the device at regular intervals and inform them about the dangers.
- Provide the necessary safety equipment to the employees working with the unit (see section below).

2.4 Personal safety equipment

The protective measures required in the laboratory have to be observed and the following protective clothing worn during all work on the device:

- Safety glasses with side protection
- Protective gloves in accordance with the prevailing ambient conditions and used solvents (e.g. heat, cold, protection against chemicals)
- Lab coat
- Personalised protective safety equipment which is specified in the particular laboratory.

2.5 Safety features on the device

- Power switch: Devices of the AZURA® L series may be switched off using the power switch (toggle switch on the back side of housing) at any time, this causes no damage to the device. To switch off devices of the AZURA® S series, remove the plug from the power socket.
- Front cover: Devices of the AZURA® L series have a front cover as a splash protection for the user
- Lamp: For the detectors AZURA DAD 2.1L, DAD 6.1L und MWD 2.1L, the lamp switches off automatically when the cover is opened.

2.6 Working with solvents

2.6.1 General requirements

- The user is trained for handling different solvents.
- Note recommended solvents and concentrations in these instructions in order to avoid personal injury or damage to the device. For example, certain chemicals may cause PEEK capillaries to swell or burst (see chapter 19 on page 81). Note that organic solvents are toxic above a certain concentration. For handling hazardous solvents see the following section.
- Mobile phases and samples may contain volatile or combustible solvents. Avoid the accumulation of these substances. Ensure good ventilation of the installation site. Avoid open flames and sparks. Do not operate the instrument in the presence of flammable gases or vapors.
- Only use solvents which do not self-ignite under given conditions. This applies especially to the use of a thermostat where liquids could get onto hot surfaces in the interior.

2.6.2 Contamination by health-threatening solvents

- Contamination with toxic, infectious or radioactive substances poses a hazard for all persons involved during operation, repair, sale, and disposal of a device.
- All contaminated devices have to be properly decontaminated by a specialist company or the operating company before they can be recommissioned, repaired, sold, or disposed (see chapter (see chapter 18 on page 80)).

2.6.3 Avoiding leakage

Risk of electrical shock or short circuit if solvents or other liquids leak into the interior of the device. You can avoid a leakage through the following measures:

- Tightness: Visually check the device or system regularly for leaks.
- Solvent tray: The use of a solvent tray prevents liquids get from the bottles into the inside of the device.
- Eluent lines: Install capillaries and hoses in such a way that, in case of a leak, liquids cannot get into the interior of the devices underneath.
- In case of leakage: Switch off the system. Only take the device into operation if the cause of the leak has been resolved (see chapter 13 on page 51).

2.7 Specific environments

2.7.1 Earthquake-endangered areas

In earthquake-endangered areas, do not stack more than 3 devices on top of each other. Otherwise there is risk of injury due to falling devices or loose parts.

2.7.2 Explosive environment

Never use the system in potentially explosive atmospheres without appropriate protective equipment. For more information, contact the KNAUER Customer Support.

2.7.3 Cooling room

You may operate the device in a cooling room. To prevent condensation, note the following instructions:

- Allow the device to acclimatize for min. 3 hours before taking it into operation.
- After taking into operation, the device should stay switched on.
- Avoid temperature fluctuations.

2.7.4 Wet room

The device must not be operated in wet rooms.

2.8 Maintenance, care and repair

- Avoiding electric shock: Before performing any maintenance and service work, disconnect the device from the power supply.
- Tools: Use only tools recommended or prescribed by the manufacturer.
- Spare parts and accessories: Only use original parts and accessories made by KNAUER or a company authorized by KNAUER.
- PEEK fittings: Use PEEK fittings only for a single port or brand-new PEEK fittings in order to avoid dead volume or not exactly fitting connections.
- Column care: Follow KNAUER or other manufacturer's instructions on caring for the columns (see www.knauer.net/columncare)
- Used capillaries: Do not use any used capillaries elsewhere in the system in order to avoid dead volumes, not exactly fitting connections and spreading contamination.
- Safety features: The device may only be opened by the KNAUER Customer Support of KNAUER or any company authorized by KNAUER (see chapter 1.4.1 on page 2).
- For more information visit the KNAUER website: www.knauer.net/hplc-troubleshooting

2.9 Service request form and decontamination report

Devices which are shipped without the completed document "Service request form and decontamination report" will not be repaired. If you would like to return a device to KNAUER, make sure to enclose the completed document: www.knauer.net/servicerequest

3. Product information

- AZURA L features** The device is a member of the AZURA L product line and shares a number of common features.
- Removable front cover, for optional device and/or operator protection. The removal of the front cover of the AS 6.1 L leads to the decrease of the syringe speed.
 - Instrument stability through a large base area and low center gravity.
 - Power connection and control connectors on rear of device.
- Identification** The device name can be found on the front panel, above the serial number. A silver sticker on the rear side displays the manufacturer name, address and power supply specifications.

3.1 Intended use



Note: Only use the device for applications that fall within the range of the intended use. Otherwise, the protective and safety equipment of the device could fail.

Operating ranges

The device can be used in the following areas:

- Biochemical analyses
- Chemical analyses
- Food analyses
- Pharmaceutical analyses
- Environmental analyses

3.2 Performance features

To make your HPLC/UHPLC separations as efficient as possible, pay close attention to the following:

- Use ultra-pure, filtered solvents - Gradient grade - for HPLC/UHPLC.
- Filtration of substances under analysis
- Use of inline filters

3.3 Device versions

	HPLC+	UHPLC	Bio	Prep
Maximum back pressure	1000 bar	1240 bar	345 bar	350 bar
Sample needle	15 µl	15 µl	15 µl	60 µl
Dispenser syringe	250 µl	250 µl	250 µl	2500 µl
Buffer tubing	500 µl	500 µl	500 µl	2000 µl
Sample loop	100 µl, 0.4 mm ID	10 µl, 0.18 mm ID	100 µl, 0.4 mm ID	10 ml
Order number	AAA50AA	AAA10AA	AAA20AA	AAA40AA
Order number (cool/heat option)	AAA51AA	AAA11AA	AAA21AA	AAA41AA*

* also available as biocompatible version: AAA31AA

3.4 Views

3.4.1 Front view

Legend

- ① Capillary guide
- ② Removable door
- ③ Removable side parts
- ④ Connection for drainage hose



3.4.2 Rear view

The following components, connections and warnings can be found at the rear panel:

Legend

- ① LAN connection
- ② I/O connection (9-pin)
- ③ Power switch
- ④ Fuse box
- ⑤ Socket for power connection
- ⑥ Optional ventilator for Cool/Heat-Version
- ⑦ Serial number and year of manufacture of device

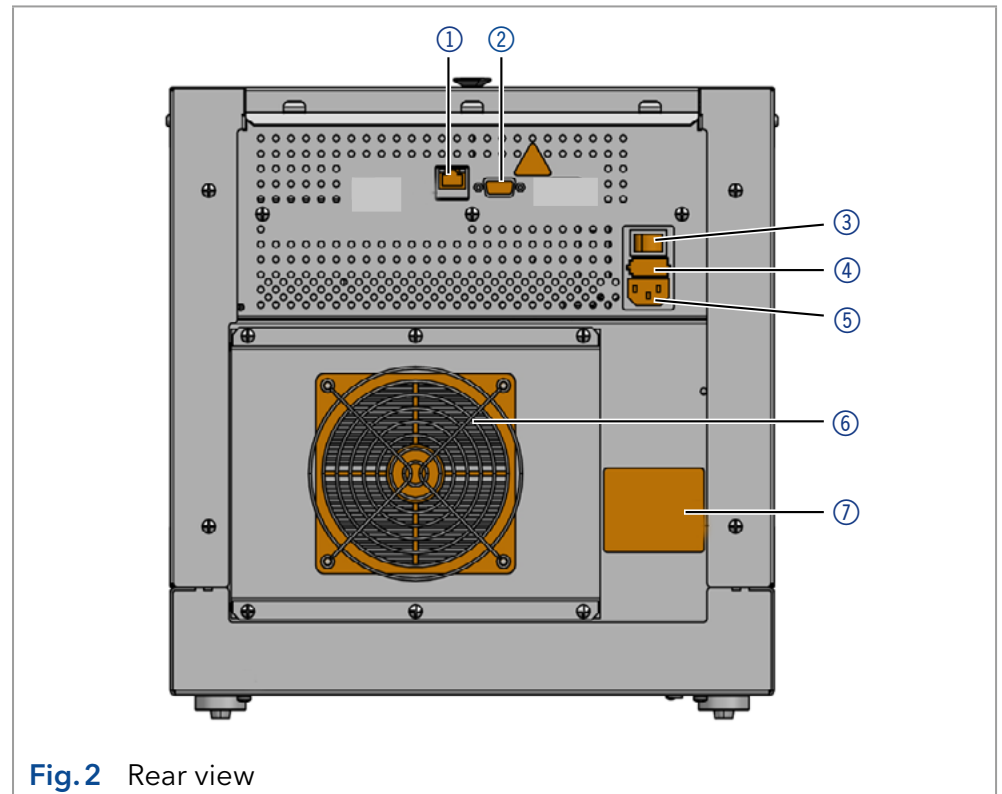

Fig.2 Rear view

Sample compartment

Legend

- ① Leak management funnel
- ② Injection valve
- ③ Valve leak bin
- ④ Sample compartment
- ⑤ Connection for drainage hose (at the side)
- ⑥ Needle wash position
- ⑦ Wash liquid bottles
- ⑧ Needle guide
- ⑨ Syringe

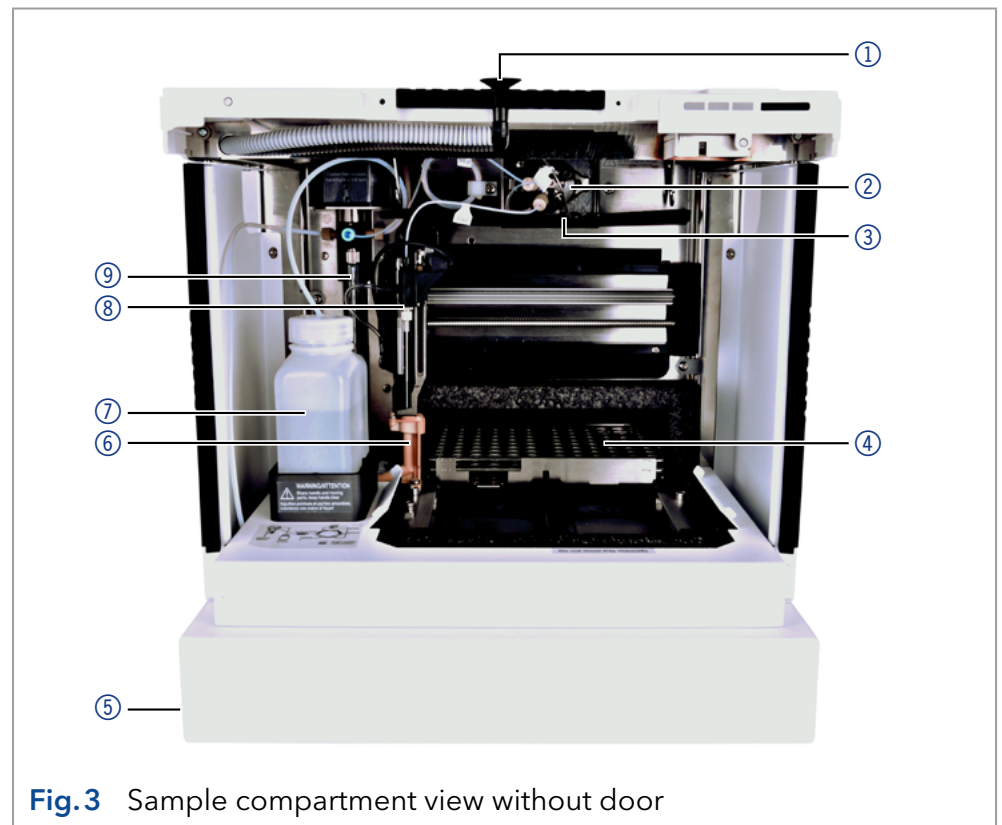

Fig.3 Sample compartment view without door

3.5 Scope of delivery



Note: Only use spare parts and accessories made by KNAUER or a company authorized by KNAUER.









- Device Autosampler AZURA® Autosampler AS 6.1L
- Power supply cable
- Accessories kit AZURA® Autosampler AS 6.1L

Applicable documents:

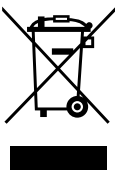
- AZURA® Autosampler AS 6.1L Instructions (Document number V6821)
- Declaration of conformity

3.6 Symbols and signs

The following symbols and signs can be found on the device:

Symbol	Meaning
	Electric shock hazard. Failure to observe this warning may result in loss of life, serious injury, damage or destruction of the device.
	Electrostatic discharge hazard. Damages to system, device, or sensitive electronic components can occur.
	A warranty seal is affixed to some devices. For more information (see chapter 1.4.4 on page 2).
	The device is covered by the Waste Electrical and Electronic Equipment Directive (WEEE Directive). It may not be disposed of as unsorted municipal waste and has to be collected separately. For more information (see chapter 18 on page 80).
	The device complies with the product-specific requirements of the European Union.
	The device complies with the product-specific requirements of the United Kingdom.
	The device has successfully passed the TÜV tests for quality and safety. The TÜV Germany is a nationally recognized testing agency (NRTL) in Canada and the USA.
	The electromagnetic interference from the device is below the limits approved by the Federal Communications Commission (FCC).
	The device complies with the Australian EMV regulations.
CAN ICES-3 (B)	The device complies with Industry Canada license-exempt RSS standards.

Symbol Meaning



The device can be used for 15 years according to its intended use before there is a risk that the contained substances may escape and thereby pose a risk to the environment and health.

部件名称	有毒及危险物质或元素					
	铅	汞	镉	铬(VI)	多溴联苯	多溴二苯醚
印刷电路板	O	O	O	O	O	O
机电部件	O	O	O	O	O	O
电缆和电线	O	O	O	O	O	O
金属部件	X	O	O	O	O	O
塑料部件	O	O	O	O	O	O
电池	O	O	O	O	O	O
显示	n/a	n/a	n/a	n/a	n/a	n/a

O = 表示部件中所有同质金属中的有毒和危险物质含量低于SJ/T 11363-2006中描述的浓度极限要求。(表示部件中所有同质金属中的有毒和危险物质含量低于SJ/T 11363-2006中描述的浓度极限要求。*)

X = 表示部件中所有同质金属中的有毒和危险物质含量超过SJ/T 11363-2006中描述的浓度极限要求。(表示部件中所有同质金属中的有毒和危险物质含量超过SJ/T 11363-2006*中描述的浓度极限要求。*)

Part Name	toxic and hazardous substances or elements					
	Pb	Hg	Cd	Cr(VI)	PBB	PBDE
PCB	O	O	O	O	O	O
Electromechanical parts	O	O	O	O	O	O
Cables & wires	O	O	O	O	O	O
Metal Parts	X	O	O	O	O	O
Plastic parts	O	O	O	O	O	O
Batteries	O	O	O	O	O	O
Display	n/a	n/a	n/a	n/a	n/a	n/a

O = Indicates that the content of the toxic and hazardous substances in all homogenous Materials of the part is below the concentration limit requirements as described in SJ/T 11363-2006. (Indicates that the content of the toxic and hazardous substances in all homogenous Materials of the part is below the concentration limit requirements as described in SJ/T 11363-2006.*)

X = Indicates that the content of the toxic and hazardous substances in all homogenous Materials of the part is exceeds the concentration limit requirements as described in SJ/T 11363-2006. (Indicates that the content of the toxic and hazardous substances in all homogenous Materials of the part is exceeds the concentration limit requirements as described in SJ/T 11363-2006.*)

4. Installation and initial startup

Before you determine the operation site, read the chapter “Technical Data” (page 75). There you will find all device-specific information on power supply, ambient conditions and humidity.



Note: The intended use be ensured only if the requirements for ambient conditions of the operating environment are met.

⚠ CAUTION

Lifting hazard

The device weighs more than 18 kg. If it falls, it may cause injury.

→ Only carry the device with two people.

4.1 Unpacking

Process

Procedure

1. Place the packaging in such a way that the lettering on the label is in the correct position.
2. Check the packaging, the device and the accessories for transport damage.
3. Check the scope of delivery. In the event of incomplete delivery, contact Technical Support immediately.
4. When lifting, carrying or moving the device, grab the unit only from below on the sides. Do not hold onto front cover, as it is loosely attached to the device.

Next steps

- Keep the included packing list for repeat orders.
- Keep the original packaging for safe storage or transportation.

4.2 Ambient conditions

4.2.1 Operation site

Observe the following requirements for the operation site so that the measurement results are not influenced:

- Place on a firm, level and straight surface.
- Protect against direct sunlight.
- Do not expose to air drafts such as air conditioning systems.
- Do not set up the to other machines that cause floor vibrations.
- Keep from high frequency sources.
- Ensure adequate ventilation (see chapter 4.2.3 on page 15).
- Avoid temperature fluctuations (see chapter 4.2.2 on page 14).

4.2.2 Ambient temperature

If the ambient temperature of the device is abruptly changed (e.g. when it is installed in a cooling chamber), condensation will form inside the device and may cause damage to the device.

Allow the device to acclimate for 3 h, before it is connected to the power supply and taken into operation.

4.2.3 Space requirements

- Make sure that the power plug on the power supply (wall socket or power strip) is always accessible, so that the device can be disconnected from the power supply.
- Ensure adequate ventilation around the device, otherwise it may overheat and malfunction:
 - Min. 5 cm distance if another device is set on one side.
 - Min. 10 cm distance if further devices are set on both sides.
 - At least 15 cm to the cooler fan on the rear.
- The mounting of a small device to an AZURA L device with a mounting bracket does not affect the performance of either device. The space requirements specified in both device instructions do not apply in this case.

4.3 Power supply

Power supply requirements

- Failure-free power supply: For failure-free operation, the electrical voltage has to be free of fluctuations, residual currents, voltage peaks and electromagnetic interference. The device has to receive sufficient voltage and reserve capacity.
- Check voltage: Only connect devices to a power supply whose voltage corresponds to the permissible voltage of the device.
- Power consumption: The nominal power of the connected devices must not exceed 50 % of the highest connected power capacity, since higher currents can flow briefly when the device is switched on.
- Main connection: The electrical power supply at the operation site has to be connected directly to the nearest main power connection.
- Grounding: The connectors for the voltage have to be grounded accordingly.

Power supply cables and plugs

- Original parts: For power supply, use the supplied power cable and plug to meet the specifications which are described in the chapter "Technical Data" (page 75). Detachable power cable cables are not allowed to be replaced with other cable types.
- Country-specific plugs: Before switching on the device, check whether the supplied plug is approved for your country. Overview of the device- and country-specific plug types from KNAUER:
www.knauer.net/plugs
- Power strips: If several devices are connected to one power strip, always consider the maximum power consumption of each device.
- Access to power supply: Make sure that the power plug on the power supply (wall socket or power strip) is always accessible, so that the device can be disconnected easily from the power supply.
- Damaged power supply cables and plugs: Damaged or faulty cables and plugs must not be used to connect the device to the power supply. Replace defective cables and plugs only with KNAUER accessories.

4.4 Leak management

The leak drainage system of AZURA L devices placed on the AS 6.1L is guided to the waste management of the autosampler (see Fig.3, Leak management funnel ). For more information please check the section "Connecting the leak management" in the respective device manual.

4.5 Computer control



Note: HPLC devices from KNAUER only work with IP addresses, which have been assigned by IPv4. IPv6 is not supported.

This chapter describes how to set up a chromatography system in a local area network (LAN) and how a network administrator can integrate this LAN into your company network. The description applies to the operating system Windows® and all conventional routers.



Note: When using PurityChrom®, static IP addresses are needed (see chapter 4.5.2 on page 17).

4.5.1 Setting up LAN

To set up a LAN, we recommend to use a router. That means the following steps are required:

Process

- Procedure**
1. On the computer, go to the control panel and check the LAN properties.
 2. Hook up the router to the devices and the computer.
 3. Set up the router for the computer network.
 4. Install the chromatography software.
 5. Switch on the device and run the chromatography software.

Next steps Configure LAN properties (see section 4.5.2).

4.5.2 Configuring LAN settings

The LAN uses only one server (which is normally the router) from that the devices automatically receive their IP address.

- Prerequisites**
- In Windows, power saving, hibernation, standby, and screen saver has to be deactivated.
 - In case you use an USB-to-COM box, the option "Allow the computer to turn off this device to save power" in the Device Manager has to be deactivated for all USB hosts.
 - Applies to all LAN devices: Disable the setting for the network adapter in Device Manager "Allow the computer to turn off this device to save power".

Process

- Procedure**
1. In Windows, open <Network and Sharing Center>.
 2. Double-click on <LAN connection>.
 3. Click on the button <Properties>.
 4. Select <Internet Protocol version 4 (TCP/IPv4)>.
 5. Click on the button <Properties>.

Process

6. Check the settings in the tab <General>. The correct settings for the DHCP client are:
 - a) Obtain an IP address automatically
 - b) Obtain DNS server address automatically
7. Click on the button <OK>.

Next steps Connect devices (see section 4.5.3).

4.5.3 Connecting devices with LAN

A router ② has several LAN ports ③ and one WAN port ④ that can be used to integrate the LAN into a wide area network (WAN), e.g. a company network or the Internet. In contrast, the LAN ports serve to set up a network from devices ① and a computer ⑤. To avoid interference, we recommend operating the chromatography system separately from the company network.



Note: You will find patch cables for each device and the router in the accessories kit. To connect the router to a LAN, an additional patch cable is required, which is not supplied within the scope of delivery.

Legend

- ① Devices
- ② Router
- ③ LAN ports
- ④ WAN/Internet connection
- ⑤ Computer

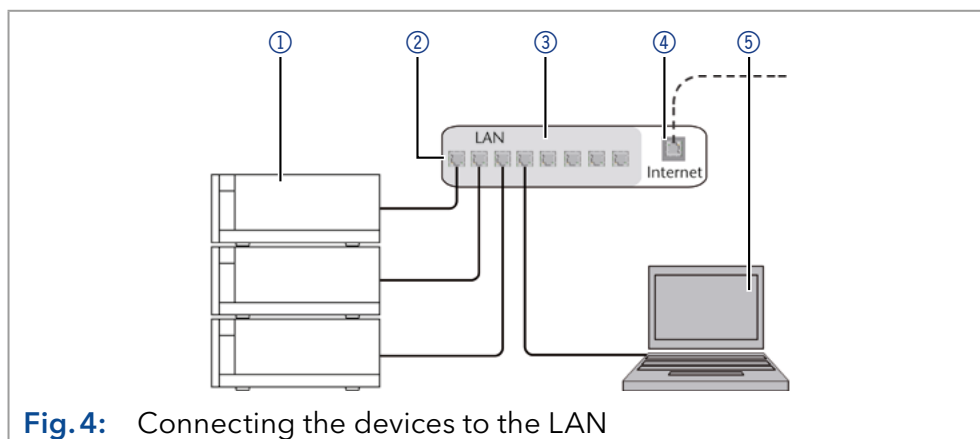

Fig.4: Connecting the devices to the LAN

- Prerequisites**
- The computer is switched off.
 - There is a patch cable for each device and the computer.

Process

- Procedure**
1. Use the patch cable to connect the router and the computer. Repeat this step to connect all devices.
 2. With additional patch cables, connect all devices individually with the router.
 3. Use the power supply to connect the router to the mains power system.

Next steps Set the router properties (see section 4.5.4).

4.5.4 Configuring the router

The router is preset at the factory. Information about address, user name and password is noted in the router manual:

www.knauer.net/en/Support/Library/PC-hardware

	Process
Procedure	1. To open the router configuration, start your Internet browser and enter the IP address (does not apply for all routers).
	2. Enter user name and password.
	3. Configure the router as DHCP server.
	4. In the router configuration, check the IP address range and make changes if necessary.



Note: If the IP address range has been changed, it is essential to note this information on the router.

Result Once the router has assigned IP addresses to all devices, the chromatography software can be used to remotely control the system.

4.5.5 Integrating LAN into the company network

A network administrator can integrate the LAN into your company network. In this case you use the WAN port of the router.

Prerequisites

- There is a patch cable for the connection.

	Process
Procedure	1. Make sure that there is no overlap between the IP addresses of the router and the corporate network.
	2. In case of an overlap, change the IP address range of the router.
	3. Use the patch cable to connect the router WAN port to the company network.
	4. Restart all devices, including the computer.

Result The LAN is now integrated into the company network.

4.5.6 Controlling several systems separately in LAN

Devices connected to a LAN communicate through ports, which are part of the IP address. If more than one chromatography systems are connected to the same LAN and you plan on controlling them separately, you can use different ports to avoid interference. Therefore, the port number for each device has to be changed and this same number has to be entered into the device configuration of the chromatography software. We recommend to use the same port number for all devices in the same system.



Note: The port is set to 2101 at the factory. You have to use the same numbers in the device configuration of the chromatography software as in the device, otherwise the connection fails.

	Process
Procedure	1. Find out port number and change it on the device.
	2. Enter the port number in the chromatography software.

Result The connection is established.

4.5.7 APIPA

APIPA is a service that allows the autosampler AS 6.1L to obtain a dynamic IP address even without a DHCP server in the network. The device has to be set to DHCP for this. If no DHCP server responds, the APIPA implementation ensures that the device gives itself a random IP address from the IP address range reserved for APIPA (169.254.x.x). This ensures that 2 devices do not use the same IP address. This process can take several minutes. At each reboot the device will use a different APIPA IP address.

Since Windows also supports APIPA, if the setting for the IP address (IPv4) is set to "Obtain automatically", a connection to the device can be established via this even without a router or fixed IP addresses. It is not recommended to use APIPA in general to establish a connection for device control by chromatography software.

5. Operation



Note: Before initial startup, wait approximately one hour until the temperature of the device has adapted to the ambient temperature.

5.1 Inserting the sample vials

5.1.1 Removing the front cover and the side parts

⚠ DANGER

Life-threatening injuries

Health danger if getting in contact with toxic or biohazardous substances as a result of a scratch or needle stick with the needle in the sample compartment.

- Operate the device only with the front panel closed.
- Stop operation before opening the front panel.

⚠ CAUTION

Stitching wounds

Behind the front panel is a chamber with a needle automatically transporting the sample during operation. Carelessness can lead to puncture injuries.

- Operate the device only with the front panel closed.
- Stop operation before opening the front panel.



Note: The speed of the auto-injection system has been increased to fulfill the requirements of ultra-high performance liquid chromatography. However, be aware that the high speed of the auto-injection system can cause stab injuries when handled inappropriately. When the door of the autosampler is open, the syringe speed is reduced automatically.

Prerequisites The device is switched off.

Tools Allen wrench, 2.5 mm

Process

1. Hold the front cover ① on both sides and remove it forwards.

Figure

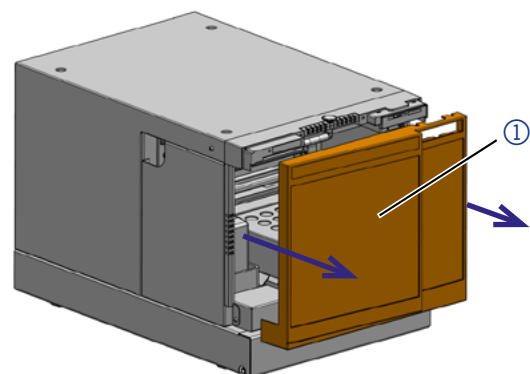
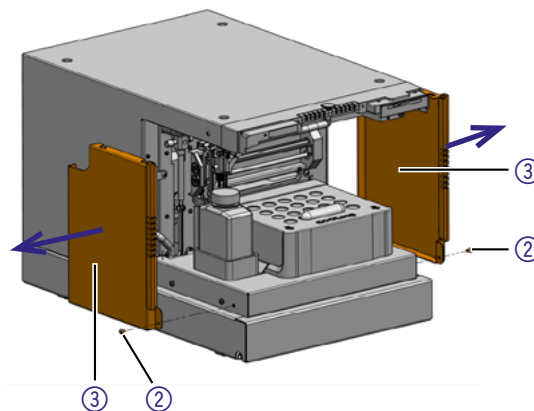

Fig.5 Removing the front cover

Process

2. Loosen the screws ② with an allen wrench.
3. Remove the side parts ③.

Figure**Fig.6** Removing the side parts

5.1.2 Removing the cooler cover

Prerequisites

- The device is switched off.
- Front cover has been removed.

Process

1. Remove the cooler cover ① forwards.

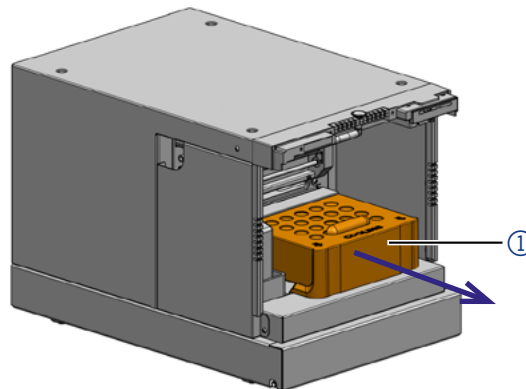
Figure**Fig.7** Removing the cooler cover

6. Injection System

6.1 PASA™ Loop injection

Loop injection with pressure assistance (Pressure Assisted Sample Aspiration PASA™) features the following:

- Samples do not have to be degassed.
- No air bubbles in sample loop.
- No clogging or contamination of sample needle.
- Precise control of syringe movement.

Legend:

- ① Buffer tubing
- ② Needle tubing
- ③ Syringe
- ④ Sample needle
- ⑤ Capillary to pump
- ⑥ Capillary to column
- ⑦ Sample loop
- ⑧ Connector for compressed air
- ⑨ Air needle

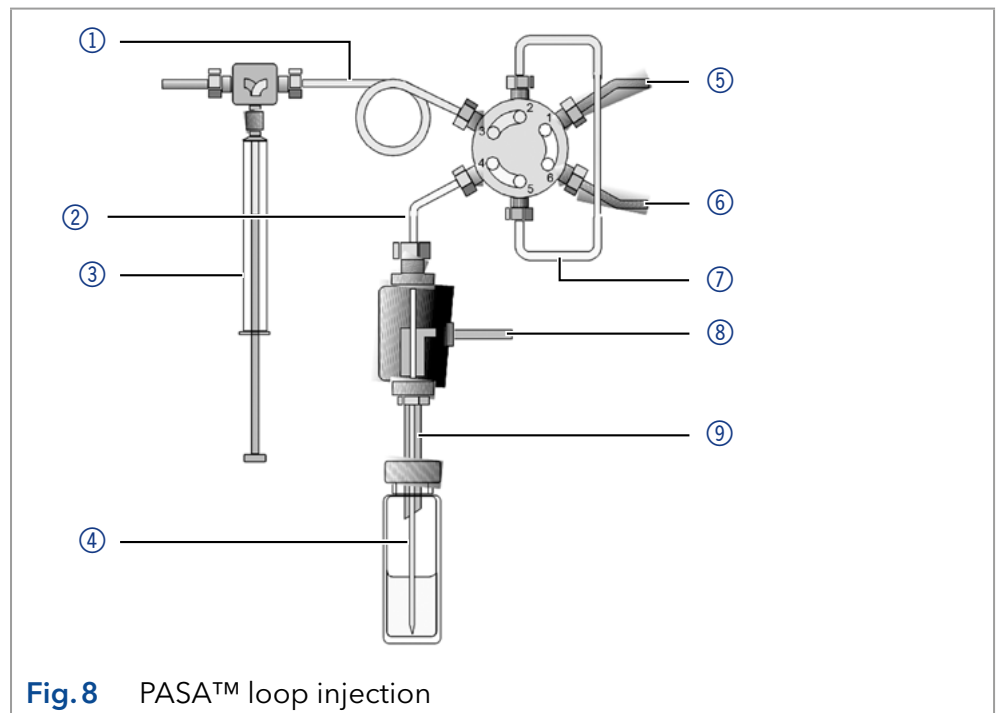

6.2 ILD™ for analytical autosamplers

For injections in the high pressure range of 700 bar or higher, the autosampler has an ILD™ valve (Intermediate Loop Decompression by Spark Holland). This valve consists of a rotor-stator combination and a central port for pressure release.

For applications in the high pressure range, pressure is released from the sample loop to avoid diluting the sample by eluent. Extremely fast switching valves reduce pressure surges further on. The results are more exact analyses and long-lasting columns.

Legend:

- ① Sample loop
- ② Syringe
- ③ Sample vial
- ④ Column
- ⑤ Pump

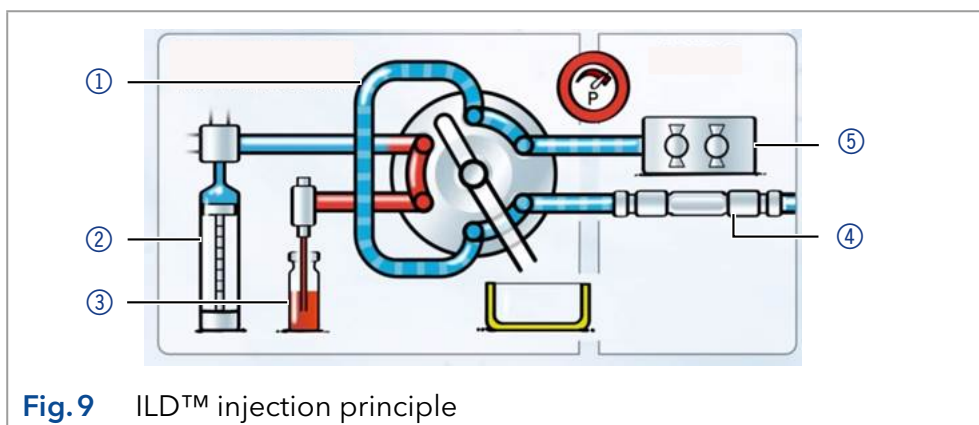

Fig.9 ILD™ injection principle

6.3 Injection principles

Legend:

- ① Transport solution
- ② Wash solution
- ③ Syringe waste
- ④ Syringe valve
- ⑤ Buffer tubing
- ⑥ Injection valve
- ⑦ Sample loop
- ⑧ Column
- ⑨ Needle tubing
- ⑩ Microtiter plate with samples

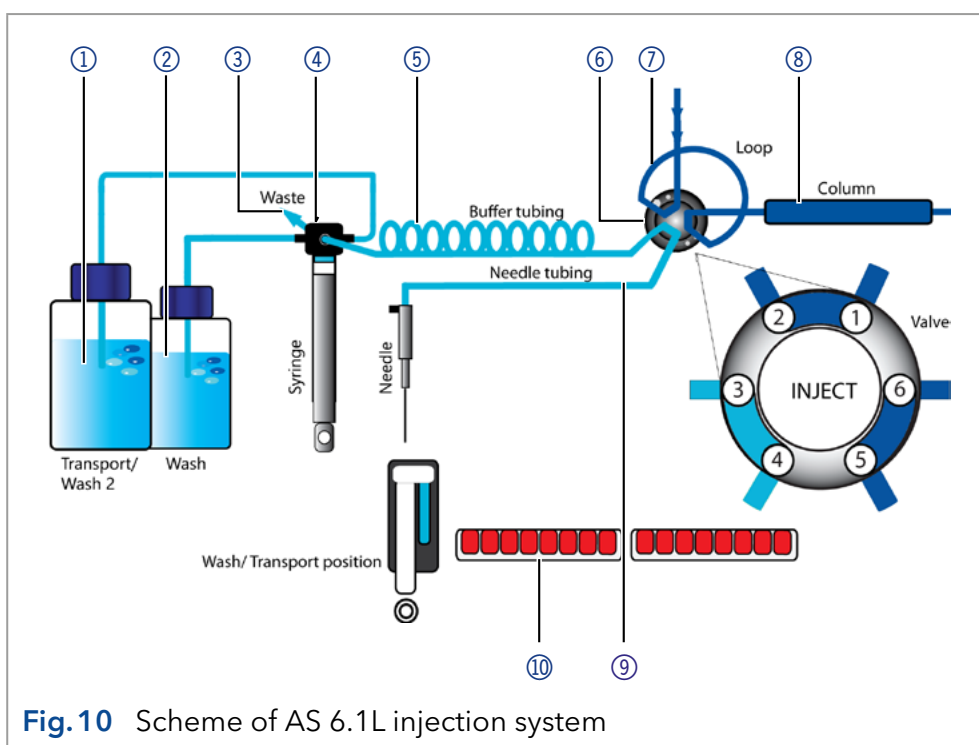

Fig.10 Scheme of AS 6.1L injection system

Three different injection methods are available:

- Full loop filling
- Partial loop filling
- μl pickup

Full loop filling

In full loop filling-mode, the sample loop is completely filled with the sample. The maximum reproducibility but not the maximum accuracy is achieved because the size of the sample loop may have a deviation of $\pm 10\%$. The maximum injection volume equals the loop volume.

The sample loop is overfilled with a multiple of the loop volume:

- 3 x loop volume for loops up to 100 µl ($\leq 100 \mu\text{l}$)
- 2 x loop volume for loops from 101 µl to 499 µl
- 1.5 x loop volume for loops of 500 µl and more ($\geq 500 \text{ ml}$)

The sample consumption per injection is the sum of the overfilling of the sample loop and the programmed flush volume.

E.g.: Full loop injection with 100 µl sample loop

- Overfill: 300 µl (100 µl of this volume is injected)
- Flush volume: 45 µl
- Total sample consumption: 345 µl

Partial loop filling

In partial loop filling mode, the sample loop is filled with sample as well as with mobile phase. It ensures the highest accuracy of the sample volume with minimal loss of sample. The maximum injection volume equals 50 % of the loop volume.

The sample loss per injection equals the programmed flush volume. Recommendation for flush volume is three times the needle volume and a minimum of 30 µl for a sample needle of 15 µl.

µl pickup

In *µl pickup* mode the sample volume aspirated from the vial is completely injected, ensuring no loss of sample. The maximum injection volume is calculated with the following formula:

$$(\text{loop volume} - 3 \times \text{needle volume})/2$$

In *µl pickup* mode the max. injection volume of an analytical autosamplers is 27.5 µl.

$$(100 \mu\text{l}^1 - 3 \times 15 \mu\text{l}^2)/2 = 27.5 \mu\text{l}$$

¹ 100 µl sample loop (standard configuration)

² 15 µl needle tubing (standard configuration)

The sample loop is only filled with a small amount of sample. The remaining volume of the loop is filled with transport liquid.



Note: In *µl pickup* mode, a 10 µl sample loop cannot be used.

For transport liquid the user can choose between the normal wash solution or a second liquid. It is recommended to select the second option and to use mobile phase in this case.

µl pickup 84+3

If the 84+3 vial plate is selected in *µl pickup* mode, the transport liquid is automatically aspirated from the three 10 ml vials. The before mentioned option to select the wash solution or a second liquid for transport is not available.

The autosampler uses a system of two telescopic needles, one that pierces through the cap of the sample vial - the air needle - and one that extracts the sample - the sample needle.

Using a syringe, the sample is aspirated through the two needles out of the sample vial while under pressure and into the sample loop. To prevent the syringe from becoming contaminated, a buffer tubing is situated

between the syringe and the injection valve. Using washing solution, sample residue is removed from the sample needle and buffer tubing.

Preparative Mode (PrepMode)

The PrepMode is intended only for the preparative AS 6.1L autosampler AAA31AA, AAA40AA and AAA41AA. For these device versions it is mandatory to activate the PrepMode via the Software.

This injection mode defines a (firmware-)fixed configuration, which is:

- 2500 µl syringe
- 10 ml sample loop
- 60 µl sample needle

Available racks:

- 2x 12x 10 ml vials
- 1x 30x 10 ml vials

The injection routine of the PrepMode is comparable to the partial loop injection mode with the following modifications:

The max. injection volume is not restricted to 50 % of the loop volume, but it's possible to fill the complete sample loop volume (up to 10 ml).

The flush volume is fixed to 60 µl, which equals the volume of the preparative sample needle and is aspirated after the injection volume.

6.3.1 Full loop filling

The sample loop is completely filled with sample. This kind of injection leads to outstanding reproducibility.

Reducing consumption

To reduce the flush volume, you can use an air segment of 5 µl. The air segment precedes the flush segment and is not injected.

The flush volume has to be at least 30 µl in case of a standard needle and an injection with air segment; in case of an injection without air segment, the flush volume has to be at least 35 µl. If samples are highly viscous it may be necessary to program larger flush volumes and reduce the syringe speed for better performance.

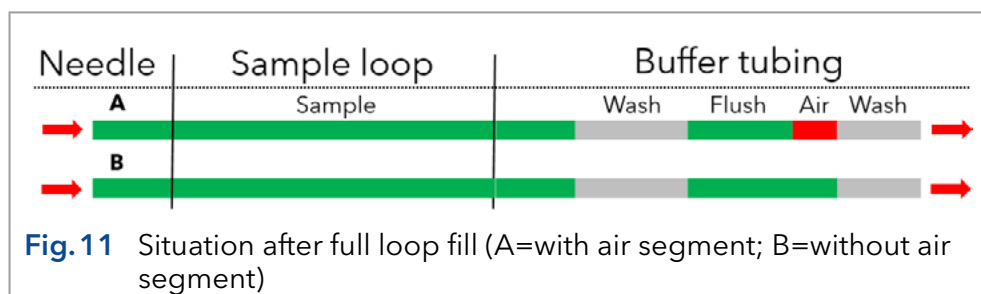

Explanations **Functional schematic**

1. Initial conditions:
The injection valve is in INJECT position. Sample needle and air needle are inserted into the vial.
2. If activated in software, *Headspace pressure* is applied through the air needle. This ensures that no air or vapor bubbles are formed during sample aspiration.

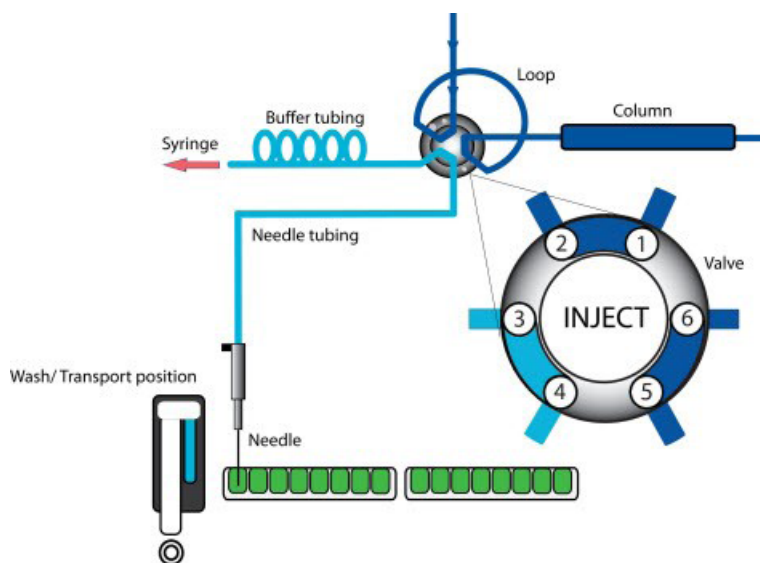

Fig. 12 Full loop filling: Initial conditions

3. The syringe aspirates the flush volume from the sample vial into the sample line and removes any washing solution.

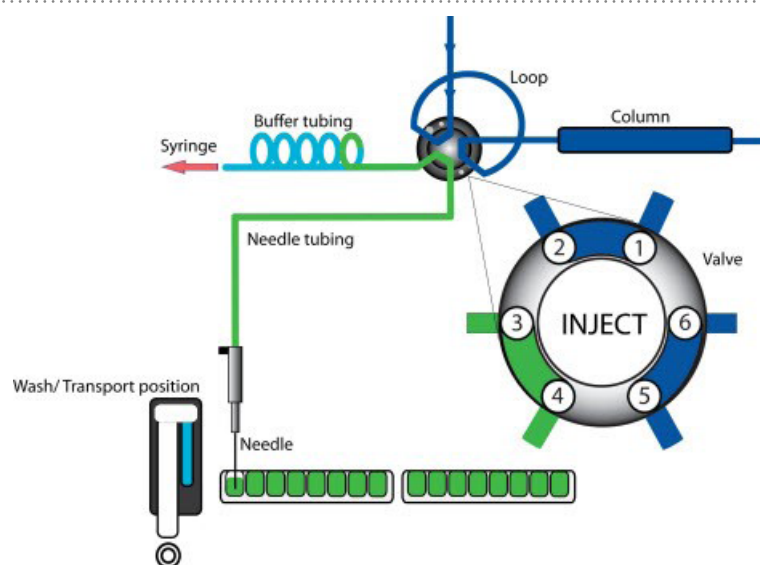

Fig. 13 Full loop filling: The needle and sample lines are flushed

4. The valve switches to LOAD position in order to transport the sample to the sample loop.

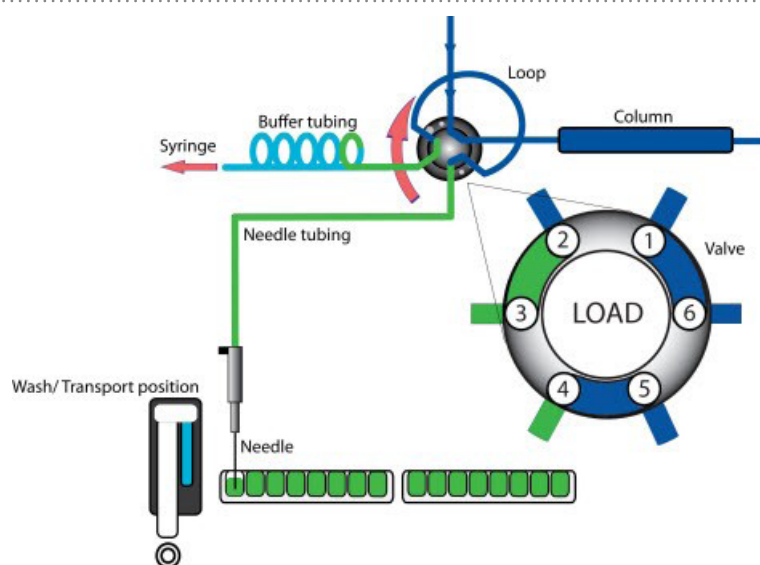

Fig. 14 Full loop filling: Valve switches to LOAD position

Explanations

Functional schematic

5. The loop is quantitatively filled with sample by aspirating a multiple of the loop volume (see "Injection principles" on page 24).

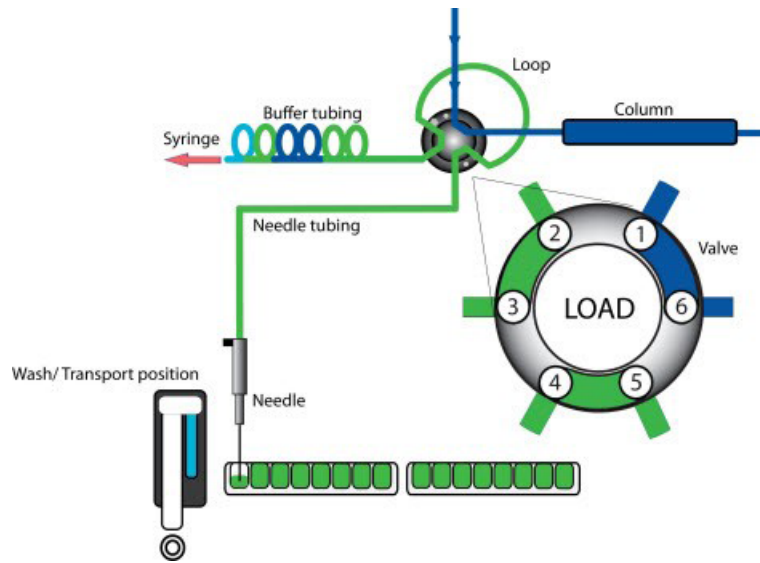

Fig. 15 Full loop filling: The sample loop is completely filled.

6. The valve switches to the INJECT position. As the sample loop is now within the flow path of the analytical system, the sample is transported to the column and the analysis starts.

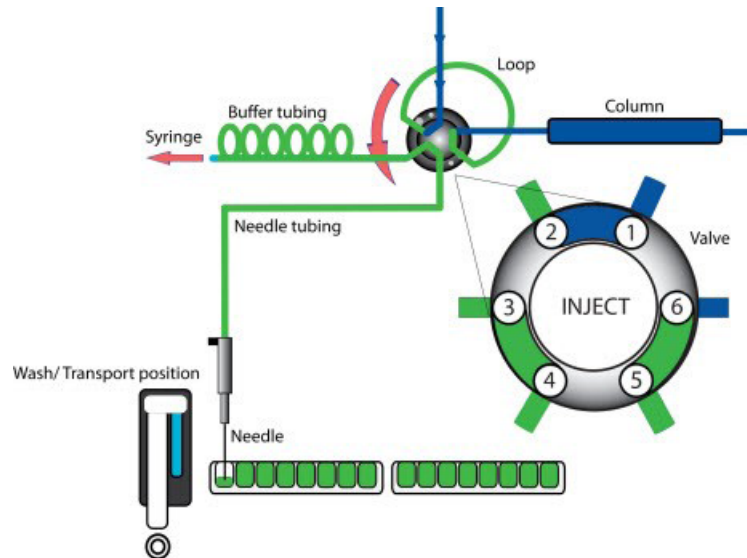

Fig. 16 Full loop filling: sample is injected

6.3.2 Partial loop filling

This kind of injection results in maximum accuracy of sample volume.

Reducing consumption

To reduce the flush volume, you can use an air segment of 5 μl . The air segment precedes the flush segment and is not injected.

The flush volume has to be at least 30 μl in case of a standard needle and an injection with air segment; in case of an injection without air segment, the flush volume has to be at least 35 μl . If samples are highly viscous it may be necessary to program larger flush volumes and reduce the syringe speed for better performance.

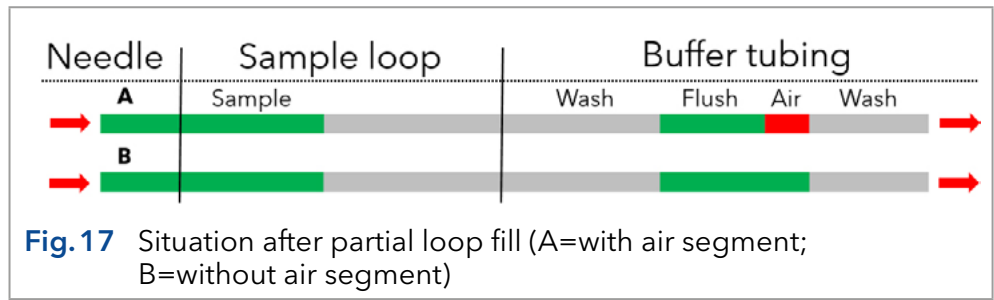

Note: Partial loop fill is processed automatically.

Process **Figure**

1. The valve is in the INJECT position. The sample needle with air needle has entered the vial/well. The buffer and needle tubings are filled with wash solution. If activated in software, *Headspace pressure* is applied through the air needle. This ensures that no air or vapor bubbles are formed during sample aspiration.

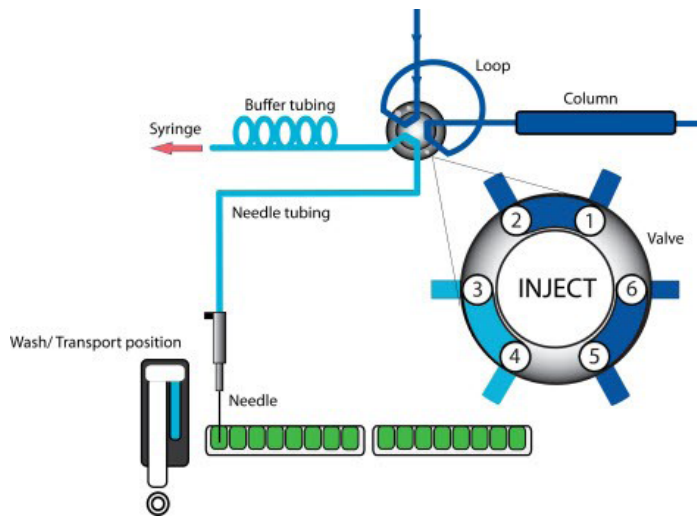

Fig. 18 Partial loop fill: Initial condition

2. The „flush volume“ is aspirated from the sample vial to remove the wash solution from the needle tubing.

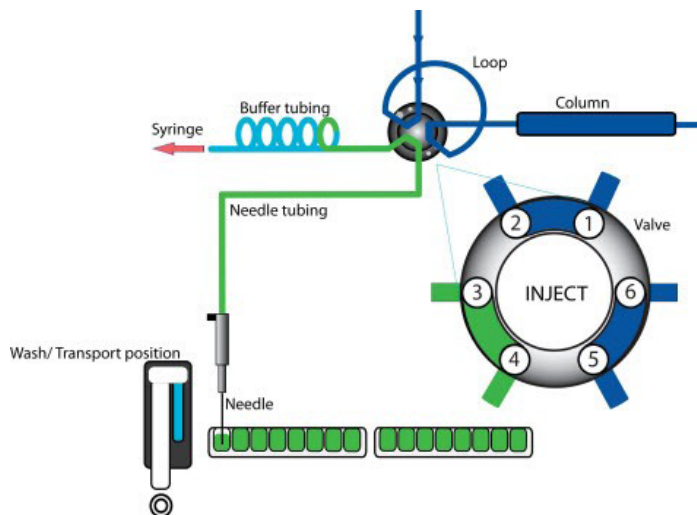

Fig. 19 Partial loop fill: Flush of needle and tubing

Process

Figure

3. The valve switches to the LOAD position.

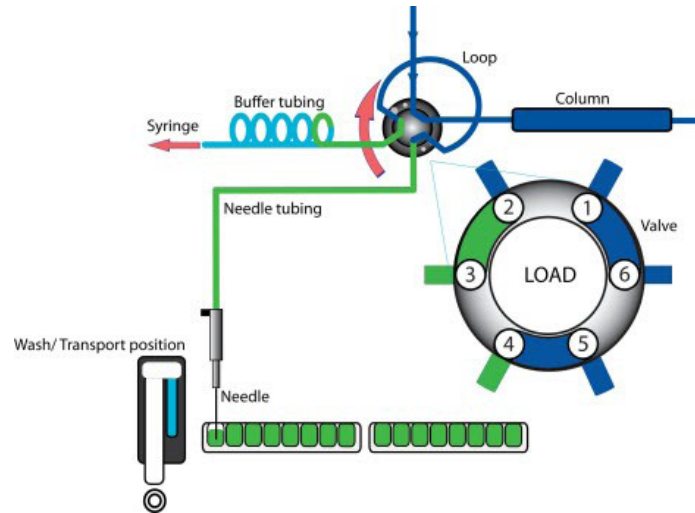

Fig.20 Partial loop fill: Injection valve switches to LOAD

4. Sample is aspirated into the loop. In this mode the loop can be filled to a maximum of 50 % with sample. The rest of the loop volume is filled with wash solution. Therefore, it is recommended to use mobile phase as wash solution.

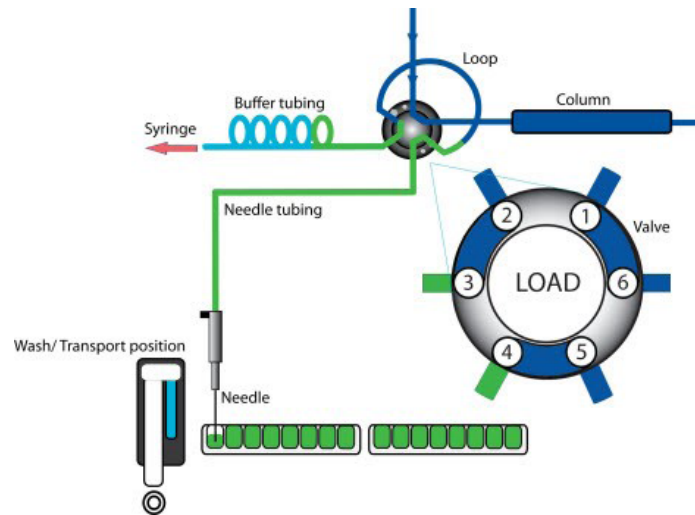

Fig.21 Partial loop fill: Sample loop is filled

5. The valve switches to the INJECT position. As the sample loop is now within the flow path of the analytical system, the sample is transported to the column and the analysis starts.

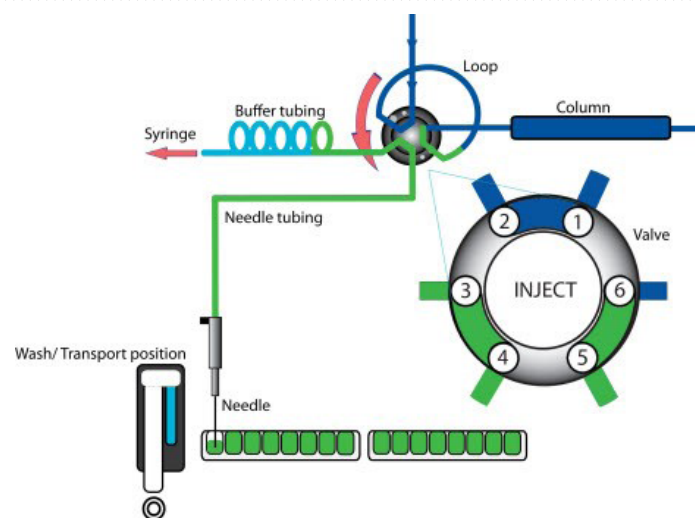

Fig.22 Partial loop fill: Sample is injected



Note: After each injection a wash routine for the syringe and the needle is performed.

6.3.3 μ l pickup

In μ l pickup mode the sample is located between two sections of transport liquid. No sample is lost due to flush procedures.

For transport liquid the user can choose between the normal wash solution or a second liquid. It is recommended to select the second option and to use mobile phase. The connection of both solution is depicted in Fig. 10.

Before using the μ l pickup mode please consider the following points:

1. In this mode the headspace pressure is deactivated as the sample volume could be distorted due to the air expansion during the movement from sample vial to loop.
2. If activated, the air segment is in front of the sample plug and injected into the HPLC system. Therefore, it is recommended to deactivate this option.
3. Make sure that wash solution and transport liquid are compatible. Use the software to flush the tubing extensively with transport liquid or wash solution.

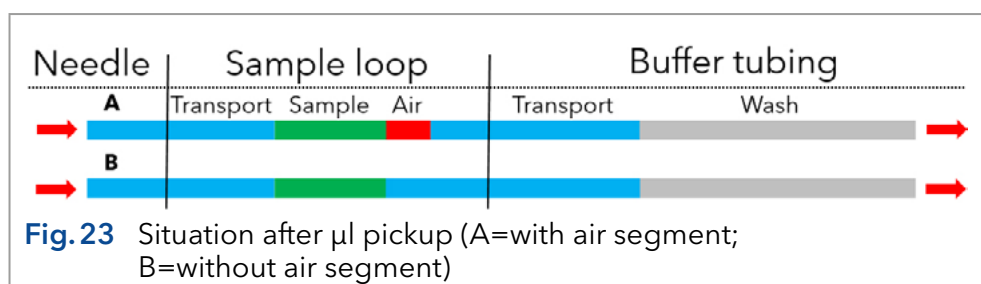

Process

1. The valve is in INJECT position. The sample needle is located in the transport position/reservoir, which is filled with transport liquid. Needle and tubing are already filled with transport liquid aspirated from the reservoir.

Figure

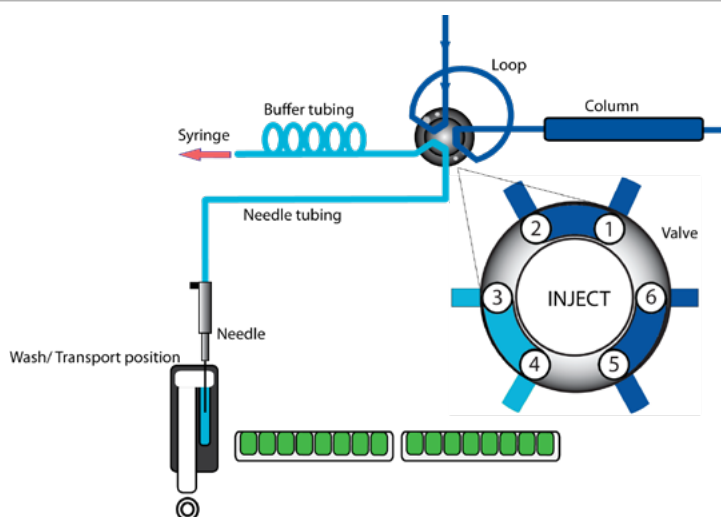

Fig. 24 μ l pickup: Initial condition

Process

Figure

- The valve switches to the LOAD position and the needle moves to the sample vial. Preceded by a segment of transport liquid, the sample is aspirated.

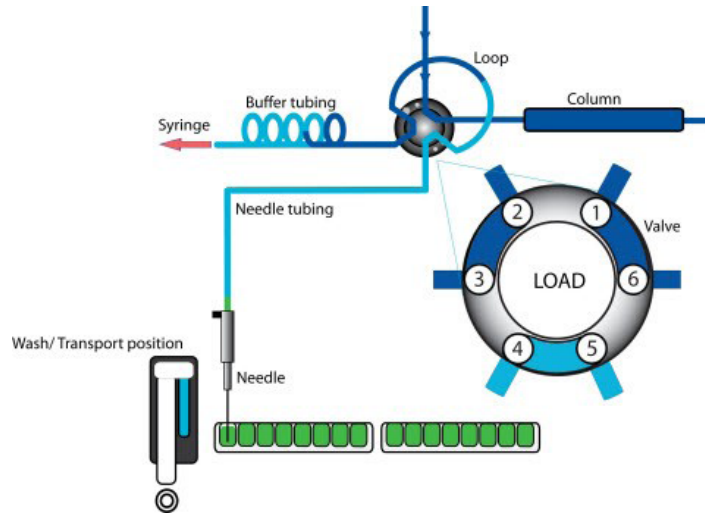

Fig.25 μ l pickup: Sample is aspirated

- After the programmed sample volume is aspirated, the needle moves back to the transport reservoir. The second transport section is aspirated, placing the sample in the middle of the loop.

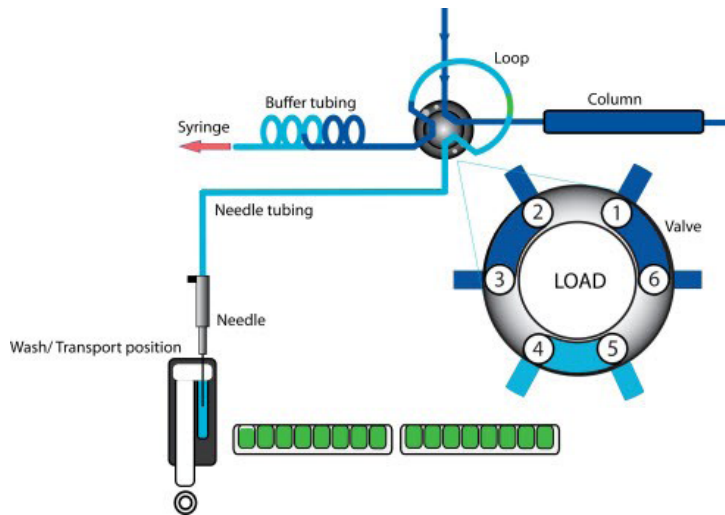

Fig.26 μ l pickup: 2nd transport segment is aspirated

- The valve switches to the INJECT position. As the sample loop is now within the flow path of the analytical system, the sample is transported to the column and the analysis starts.

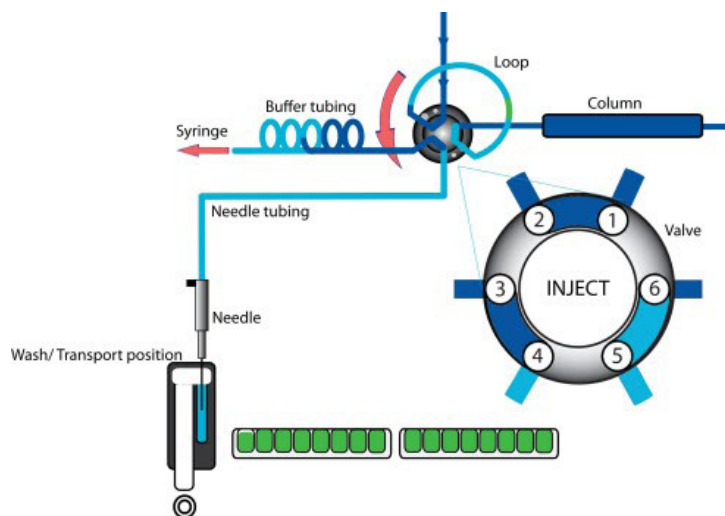

Fig.27 μ l pickup: Sample is injected

6.3.4 μ pickup with 84+3 vial plate

If you choose to operate the μ pickup mode with the 84+3 vial plate, three 10 ml vials are used automatically as source of transport liquid. In this case, the wash/transport position (transport reservoir) is only used to wash the needle. With exception of this point, the above description of μ pickup applies also for the 84+3 option.

Process

Figure

1. The valve is in INJECT position. The sample needle is located in one of the three 10 ml vials, which are filled with transport liquid. Needle and tubing are already filled with transport liquid aspirated from the vial.

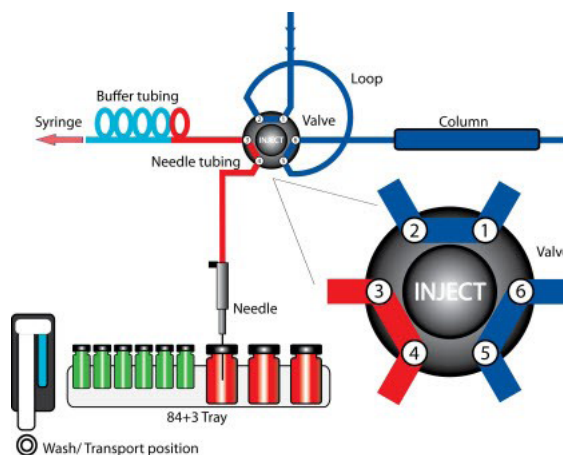

Fig.28 μ pickup 84+3: Initial condition

2. The valve switches to the LOAD position and the needle moves to the sample vial. Preceded by a segment of transport liquid, the sample is aspirated.

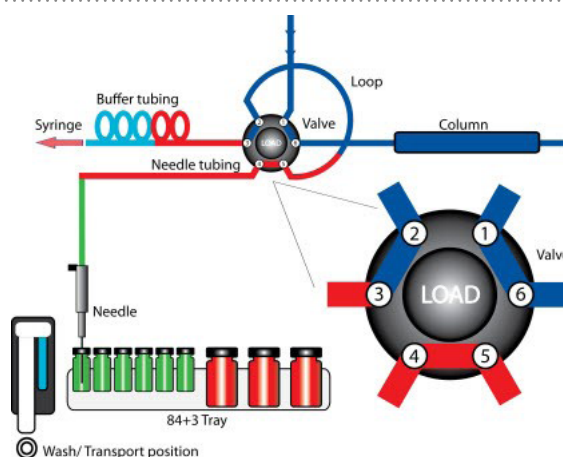

Fig.29 μ pickup 84+3: Sample is aspirated

3. After the programmed sample volume is aspirated, the needle moves back to the 10 ml vial, filled with transport liquid. The second transport segment is aspirated, placing the sample in the middle of the loop.

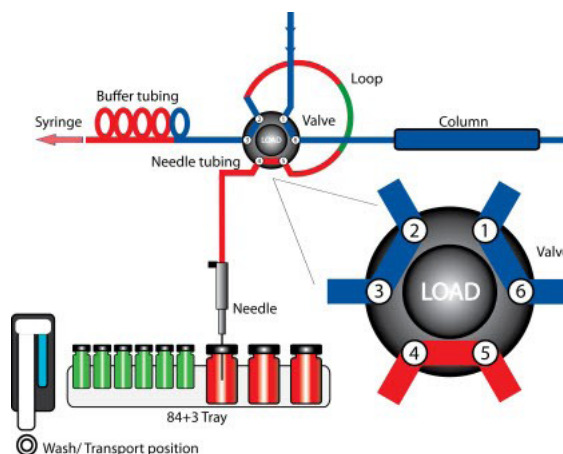

Fig.30 μ pickup 84+3: 2nd transport segment is aspirated

Process

Figure

- The valve switches to the INJECT position. As the sample loop is now within the flow path of the analytical system, the sample is transported to the column and the analysis starts.

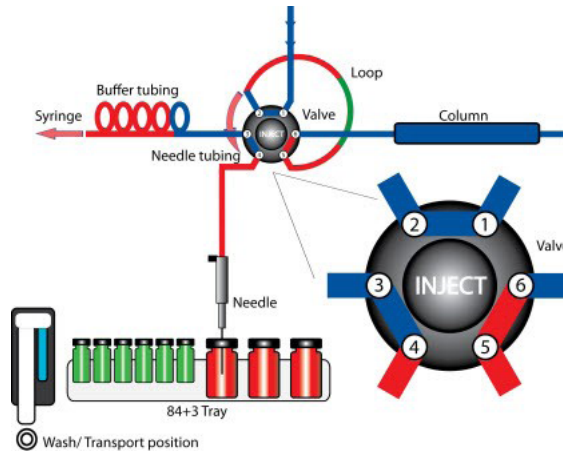

Fig.31 μ l pickup 84+3: Sample is injected

7. 84+3 vial plate

The 84+3 vial plate is not included in the accessories kit and has to be ordered separately (see chapter (see chapter 16 on page 77)). When installing the plate take care that position 87 is in the far right-hand corner of the sample compartment.

The vial plate is suited for maximum 84 vials of 1.5 ml and 3 vials of 10 ml. It was designed with the caps of all vials being level, independently from their different heights. Therefore, one needle can be used for both vial sizes (Fig. 32).

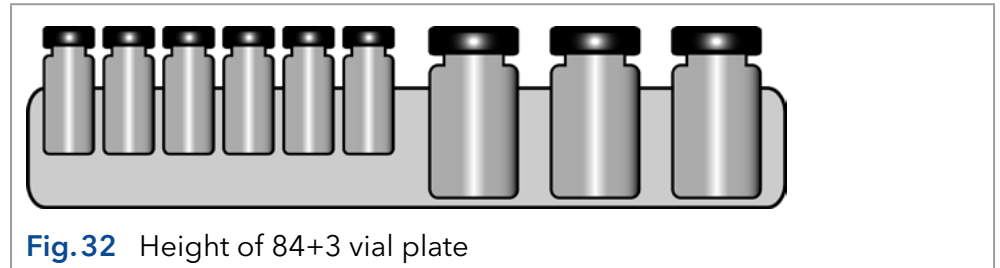

Fig.32 Height of 84+3 vial plate

Therefore, the needle height has to be programmed for the 1.5 ml vials. For the 10 ml vials two fixed needle height levels are available, depending on the transport liquid levels

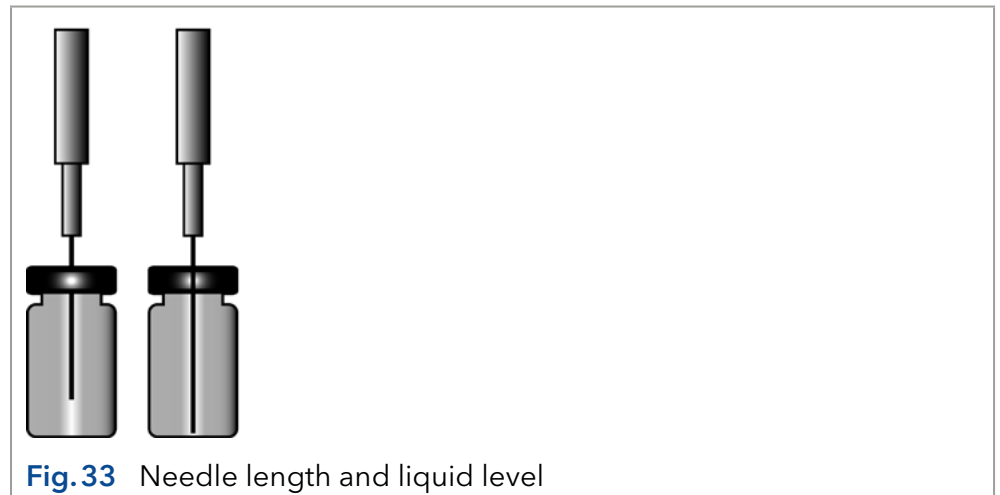

Fig.33 Needle length and liquid level

7.1 Settings for the 84+3 vial plate

Before using the 84+3 vial plate, it is necessary to change the software settings.

If you choose to operate the μl pickup mode with the 84+3 vial plate, three 10 ml vials are used automatically for transportation. In this case, the wash/transport position is only used to wash the needle.

The vial positions for the 84+3 vial plate are as follows:

Position of the first sample:	Vial positions 1-84
Position of the final sample:	Vial positions 1-84
Transport position:	Vial positions 85-87

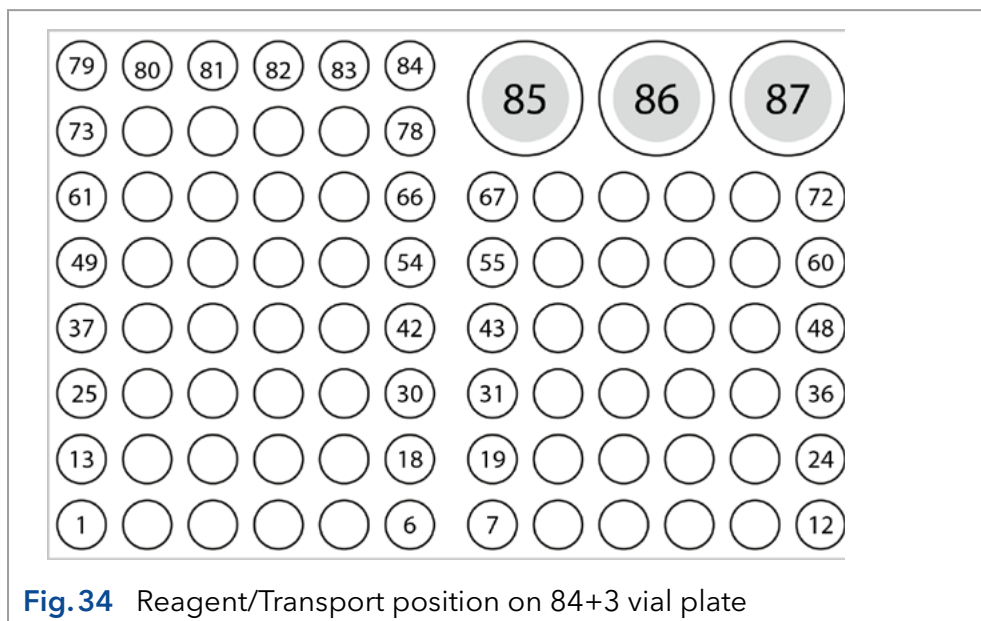

Fig.34 Reagent/Transport position on 84+3 vial plate

You need to define the first and the final sample to enter a sample range. The transport positions are always positions 85, 86, 87.

7.2 Details on programming

- Valid positions for transport vials are 85, 86 and 87. Which of the three vials is used has to be defined in the method. The transport reservoir, which is used in the normal *µl pickup* mode, cannot be selected.
- Each time the autosampler is switched on (or restarted) the liquid level of a transport vial is per default reset to 8 000 µl. Therefore, make sure that the vial is filled with at least 8 000 µl of transport liquid before system start. A reset of the filling level (to 8 000 µl) can also be done via software.
- Starting with the default filling level (8 000 µl), the autosampler automatically calculates the consumption of transport liquid. If this calculated consumption exceeds 8 000 µl, the device sends an error message and stops the current run and sequence (if programmed) - there is no automatic change to the next transport vial. Therefore, if a sequence is programmed that requires more than 8 000 µl transport liquid, the user has to program two versions of the method, which differ in the used transport vial (e.g. Method 1: transport vial = 85, Method 2: transport vial = 86).
- To avoid contamination of the air needle, the needle stops inside the transport vial in the up most position. If the volume falls below 4 000 µl, the needle moves deeper into the transport vial.
- For detailed information on method programming please check the respective software manual.

8. Air needles

Six different lengths of air needles from 50 to 80 mm are available for the autosampler. The needle holder allows you to further adjust the needle height by 6 mm.

8.1 Standard air needle

The standard air needle is 62 mm long and can be used for a wide range of high and low vial plates.

When 10 ml sample vials are used, the needle deeply penetrates the sample vial. If the vial is not filled to more than 60 %, the needle can be used. The same applies to deep microtiter plates.

For non-standard settings, use one of the optional needle types.

Legend:

- ① 10 ml sample vials
- ② 2 ml sample vials

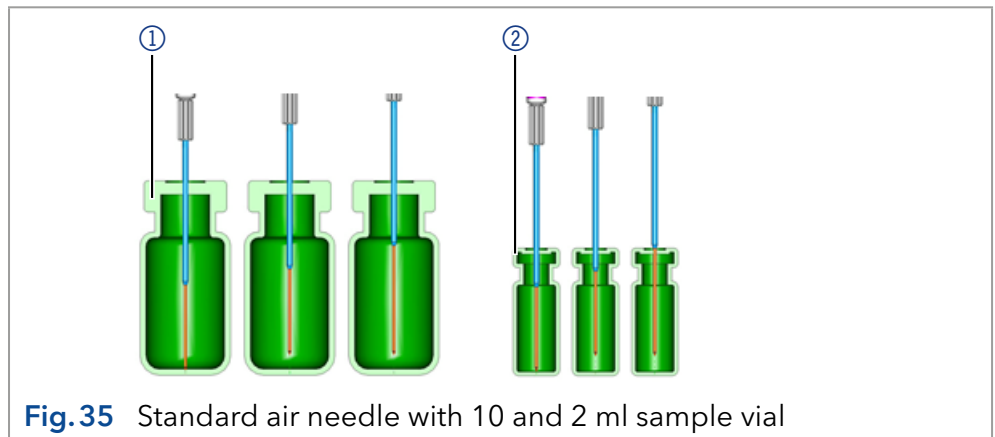

Fig.35 Standard air needle with 10 and 2 ml sample vial



Note: The PASA™ option should not be activated for low microtiter plates. The sample needle sufficiently punctures the seal to prevent vacuum and therefore the air needle is irrelevant in this case.

Legend:

- ① Deep microtiter plate with closure
- ② Low microtiter plate

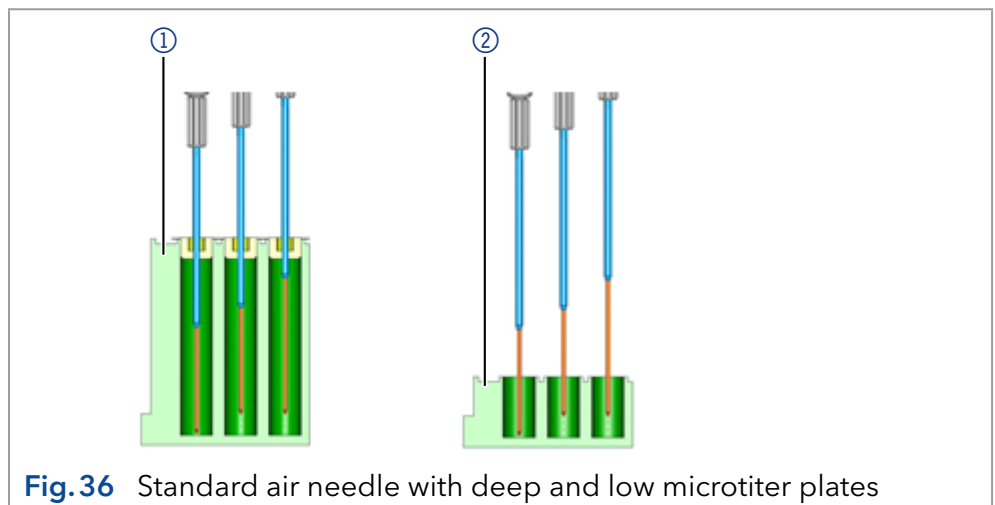

Fig.36 Standard air needle with deep and low microtiter plates

8.2 Choosing the correct air needle

To choose the correct air needle, take the following dimensions into consideration (Fig.37).

Legend

- H_t = height of sample plate
- D_w = hole depth
- C_d = thickness of closure
- N_h = set needle height
- A_c = distance from air needle tip to closure (min. 2 mm)
- P_L = Protrusion

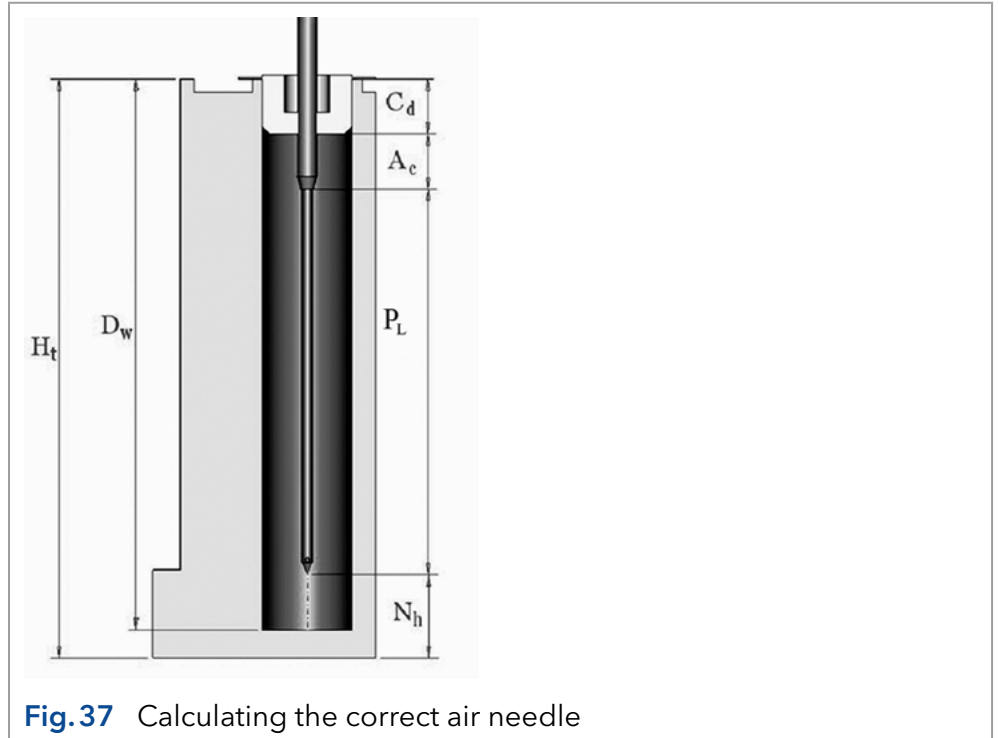

Fig.37 Calculating the correct air needle

The correct air needle is selected on basis of the protrusion length (P_L).

This is the distance between the tip of the air needle and the tip of the sample needle. As a prerequisite to choose an air needle the equation $H_t - D_w = 2-6$ mm has to be true.

The protrusion length is calculated by the following equation:

$$P_L = H_t - C_d - N_h - A_c$$

Air needle type	Protrusion length (P_L)
50 mm, yellow	34-40 mm
56 mm, red	28-34 mm
62 mm, nature (standard needle)	22-28 mm
68 mm, blue	16-22 mm
74 mm, green	10-16 mm
80 mm, black	4-10 mm

Legend:

- ① 10 ml sample vial
50 mm air needle
- ② 2 ml sample vial
62 mm air needle

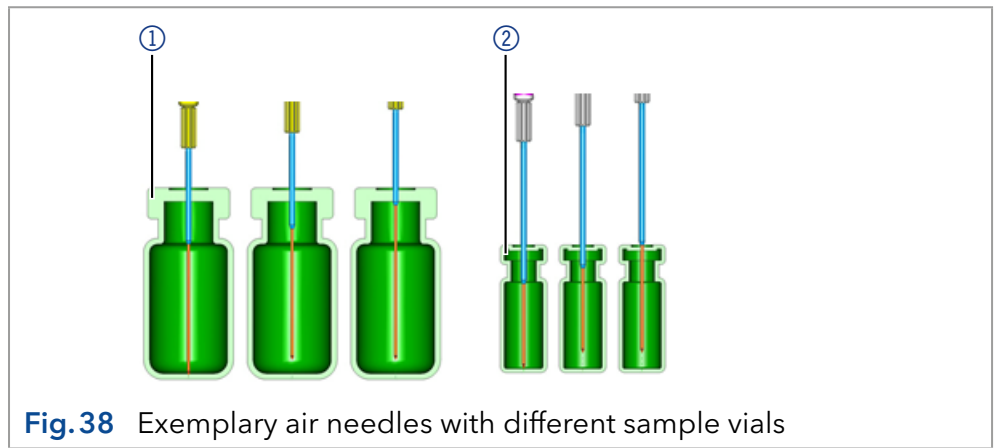
**Fig.38** Exemplary air needles with different sample vials**Legend:**

- ① Deep microtiter plate with closure, 56 mm air needle
- ② Low microtiter plate, 80 mm air needle

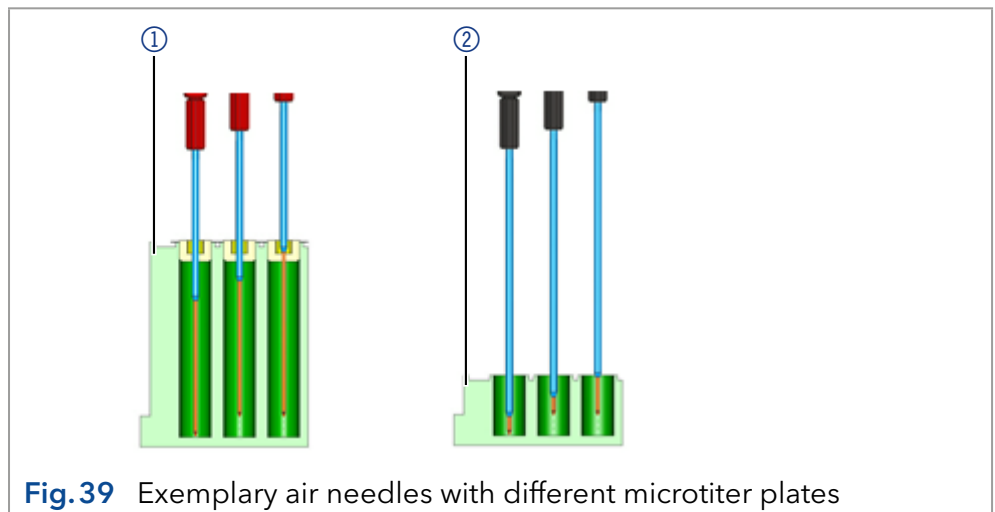
**Fig.39** Exemplary air needles with different microtiter plates**Calculation example for air needle**

Starting point:

- autosampler with standard setting for needle height.
- deep microtiter plate with closure

Dimensions:

$$H_t = 41.4 \text{ mm}$$

$$D_w = 37.8 \text{ mm}$$

$$C_d = 3.8 \text{ mm}$$

$$N_h = 6.0 \text{ mm (standard)}$$

$$A_c = 2.0 \text{ mm (minimum)}$$

Prerequisite:

$$H_t - D_w = \text{between 2 and 6 mm}$$

$$H_t - D_w = 41.4 \text{ mm} - 37.8 \text{ mm} = 3.6 \text{ mm. Condition has been met.}$$

Calculation:

$$H_t - C_d - N_h - A_c = \text{protrusion length}$$

$$41.4 \text{ mm} - 3.8 \text{ mm} - 6.0 \text{ mm} - 2.0 \text{ mm} = 29.6 \text{ mm}$$

Air needle type	Protrusion length
56 mm, red	28-34 mm

An air needle length of 56 mm is required.

8.3 Handling the sample vials

When handling the sample vials, consider the following:

- Standard vials can best be filled by means of a narrow-end pipette to allow air to escape when filling the vial.
- To prevent the sample from contaminating the air needle, do not fill the sample vials to the very top.
- Do not use uncapped sample vials, as the injection performance may not meet the specification.
- Only use air-tight closure seals to prevent air bubbles from forming and volatile components from evaporating.
- Do not use sample vials with hard closures that the sample needle cannot pierce.

9. Mix & Dilute

A mix method can be programmed for the autosampler to mix or dilute the sample fluid.

- Configure the mixing routine and syringe speed using the chromatography software.
- A maximum of 15 steps can be programmed for a Mix & Dilute method.

Three types of actions are possible:

1. Add
2. Mix
3. Wait

Add When adding, the defined volume is aspirated from either the sample vial, the vial with Reagent A or Reagent B or wash solution and then dispensed into the sample or destination vial.



Note: To prevent carryover, the autosampler aspirates 125 % of the given volume from the corresponding sample vial and uses the additional 25 % to flush the needle and tubing.

Mix When mixing, the contents of a specific sample vial is mixed by aspirating and dispensing the defined volume n times. If a destination vial has not been defined, mixing is performed in the current sample vial.



Note: When entering the Sample Vials, the Destination Vial is used automatically.

Wait With the Wait command, the system waits until the programmed delay time has elapsed before executing the next line of the program.

9.1 Example: Add

The command ADD 100 μ l from Reagent A to Destination (100 μ l Reagent A to the target vial) triggers the following steps:

1. An air segment of 5 μ l is aspirated to separate the wash solution in the needle tubing from Reagent A.
2. 25 μ l of Reagent A are aspirated to flush the needle and needle tubing.
3. The syringe is emptied through the syringe-waste position.
4. 100 μ l of Reagent A are aspirated and then dispensed into the destination vial.
5. Needle and tubing are flushed with wash solution.

9.2 Example: Mix

The command *MIX 3 times with 100 µl* triggers the following steps:

1. An air segment of 50 µl is aspirated to separate the wash solution in the needle and buffer tubing from the sample solution to be mixed.
2. The syringe is emptied through the syringe-waste position.
3. 100 µl sample solution are aspirated and dispensed back into the same sample vial.
4. Step 3 is repeated twice.
5. Needle and tubing are flushed with wash solution.



Note: If the previous *ADD* command was *TO DESTINATION*, the mixing is performed in the destination vial. If the previous *ADD* command was *TO SAMPLE*, the mixing is performed in the sample vial.

9.3 Sample positions in mixing routine

When configuring a mix method, the positions of the sample vials depend on whether the vial plates are to be processed in rows or columns.

9.3.1 Processing in columns

When column processing is used, the following positions are possible for the Sample, Destination, Reagent A and Reagent B:

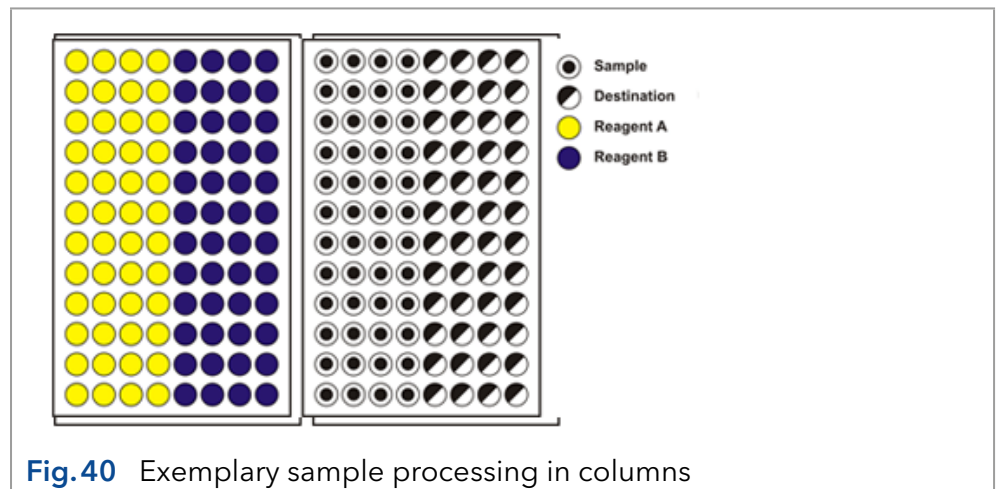

9.3.2 Processing in rows

When row processing is used, the following positions for the Sample, Destination, Reagent A and Reagent B are possible:

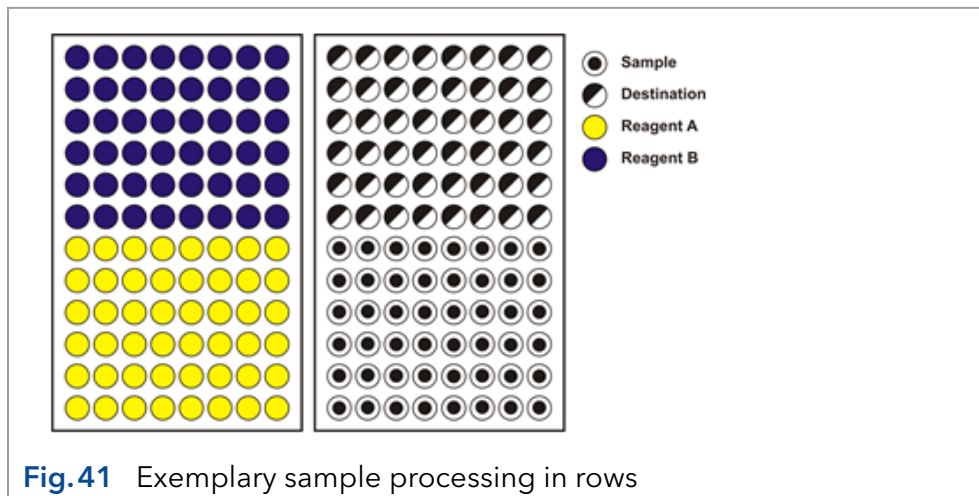

9.4 Parameters for mixing method with 84+3 vial plate

Before using the 84+3 vial plate, it is necessary to change the system configuration of the software.

The vial positions for the 84+3 vial plate are as follows:

Position for sample:	Vial positions 1-84
Position for destination:	Vial positions 1-84
Position for Reagents:	Vial positions 85-87

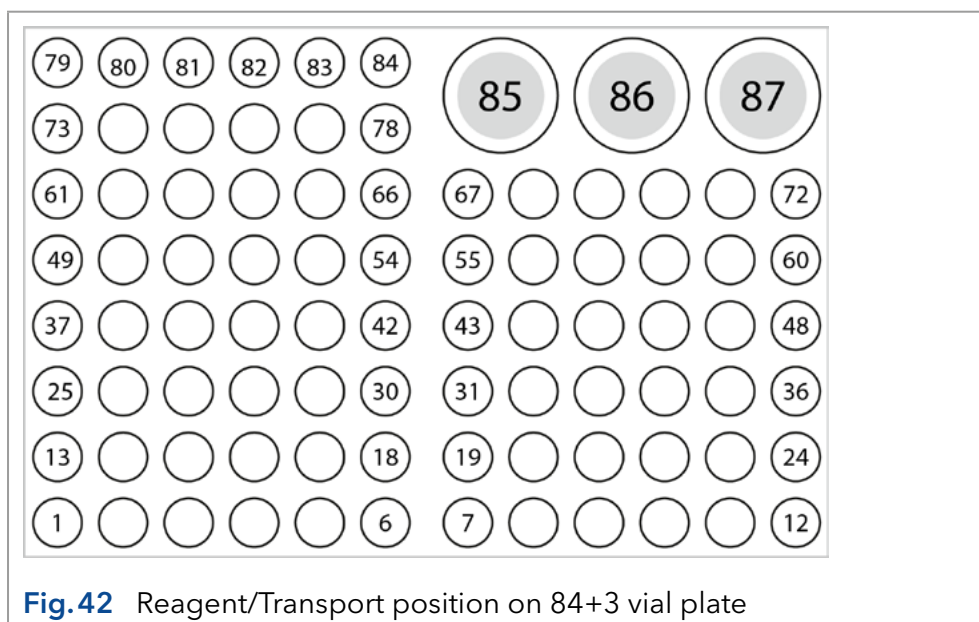

You need to define the first and the final sample to enter a sample range. The same range can be used for the destination vials. The reagent positions are always positions 85, 86, 87.

9.4.1 Details on programming the 84+3 mixing method

- The position of the reagent vial can be programmed. Possible positions are 85, 86, and 87. Position 85 per default is reserved for transport solution in case that *µl pickup* mode is used. Therefore, the default positions for Reagent A and B are 86 and 87. The system calculates the necessary reagent volume. Before system start, make sure that the vials are filled with at least 8 000 µl of liquid.
- The liquid levels of the reagent liquids are not updated at system start. To avoid contamination of the air needle, the needle stops inside the reagent vial in the up most position.
- If conducting a sample sequence or one sample per row, the autosampler takes the residual volume of the reagent liquid into account. If the volume falls below 4 000 µl, the needle moves deeper into the reagent vial. If the amount of reagent liquid reaches 0 µl, the autosampler sends an error message 370 (not enough reagent liquid available).
- The liquid levels of the reagent liquid will reset after reprogramming the mode.
- Reagent will only be taken from preprogrammed positions. The needle does not move automatically to the next reagent vial. You have to change the settings when reagent is to be taken from one of the other vials.

10. Connecting capillary and tubing

In the delivery state of the autosampler all tubings and the sample loop are already installed. The user only has to connect the pump and the column to the respective ports of the autosampler injection valve.

Please note the following points if you need to replace a tubing:

- Insert tube ends always flush with ferrule ends
- Do not overtighten nuts, as this may cause blockage in the flow path
- Make sure that you always use tubing volumes that are suitable for use with the other items in the flow path.

10.1 Valve connections

Legend

- ① Port 3 with connected buffer tubing
- ② Sample loop connected to Port 2 and 5
- ③ Port 1 to be connected with pump
- ④ Port 6 to be connected with column
- ⑤ ILDTM Port with connected waste tubing (only analytical autosampler)
- ⑥ Port 4 with connected needle tubing

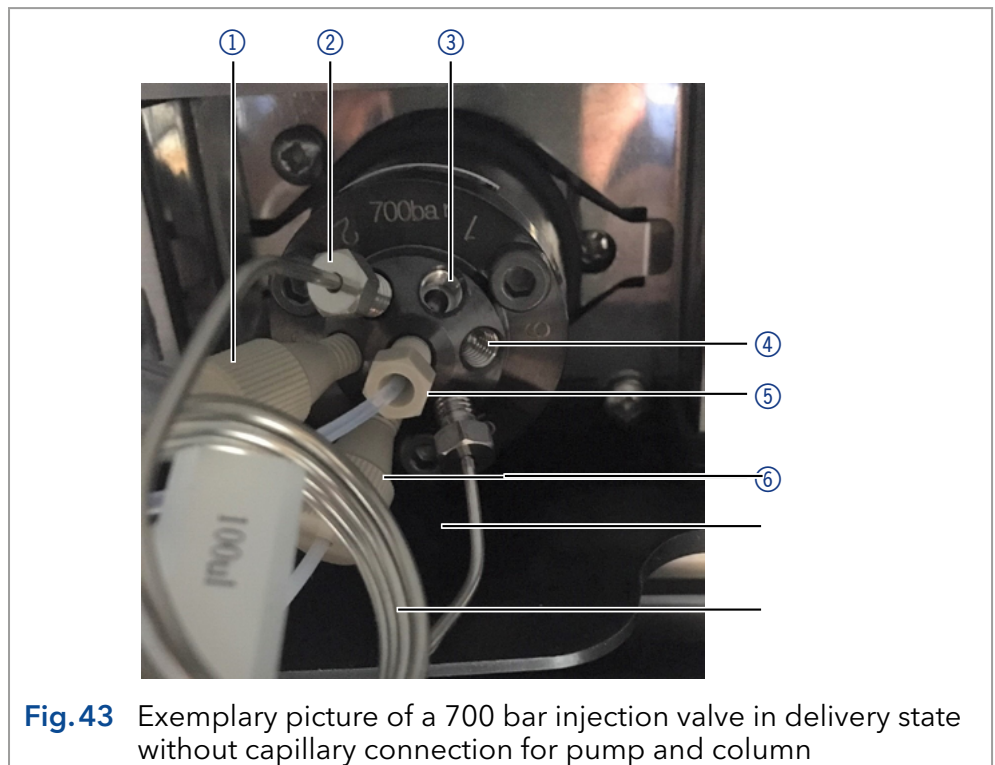

10.2 Syringe connections

Legend:

- ① Suction tube for wash solution
- ② Buffer tubing connected to injection valve
- ③ Suction tube for transport liquid

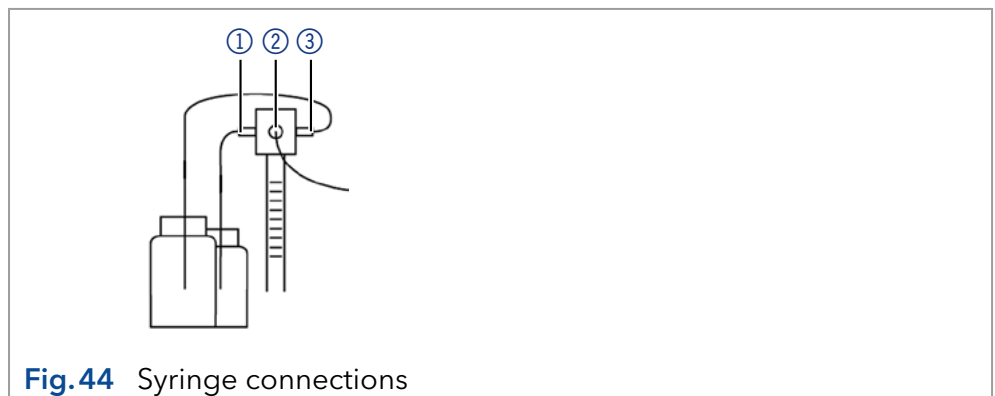

10.2.1 Tubing guide for flushing solution



Note: To prevent that the suction tubing for transport/wash 2 solution obstructs the horizontal movement of the needle unit, use the tubing guide integrated in the leakage drain.

Legend:

- ① Suction tube for transport/wash 2 solution
- ② Top view of tubing guide

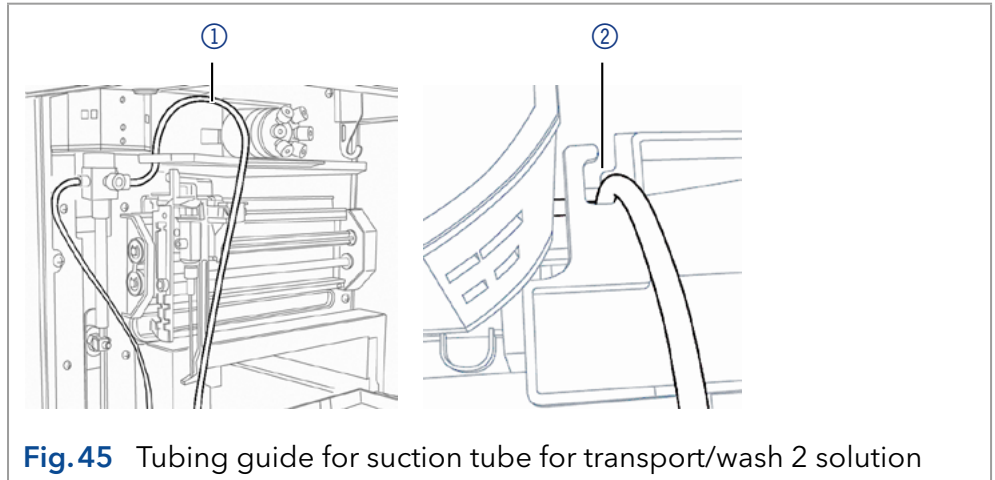

Fig.45 Tubing guide for suction tube for transport/wash 2 solution

10.3 Connecting the waste

Via the waste tube all wash and transport solution as well as non-injected sample is removed.

Connect the waste tube at the left side of the device and insert the end of the hose into a waste bottle on the floor. Make sure that the waste tube is not kinked so that the liquid can drain. If the waste tube is blocked and waste solution can not flow off, the waste will leak at the bottom of the autosampler via an additional overflow.

⚠ DANGER

Life-threatening injuries

Health danger if getting in contact with toxic vapors, toxic material or biological hazardous substances, which can escape through the overflow hole.

- ➔ Avoid overflowing the waste container.
- ➔ Clean the overflow hole after overflowing. Observe the safety regulations applicable to the materials.

Process	Figure
<ol style="list-style-type: none"> 1. Mount the waste tube at the left side of the ① device. 2. Place the waste bottle below the device. 3. Connect the waste tube to the waste bottle. 	<p>Fig.46 Waste tube connected to the AS 6.1L</p>

11. Connecting the autosampler to other devices

11.1 Controlling the autosampler with chromatography software

The autosampler is controlled directly with software, e. g. OpenLAB® and ClarityChrom® by KNAUER or Thermo Scientific™ Dionex™ Chromeleon™.

Connect the autosampler to the network, using the LAN connection at the rear panel of the device.

11.1.1 Checking and configuring the parameters of the autosampler

You can configure the autosampler parameters using the chromatography software, e.g. ClarityChrom®:

1. Select the autosampler in LAN.
2. Set the syringe volume according to the installed syringe.
3. Choose the cool/heat option if your autosampler offers temperature control.

11.1.2 Configuration window of ClarityChrom®

Legend:

- ① Serial number
- ② Device detection in local network
- ③ Manual search for device in network
- ④ Volume of sample loop
- ⑤ Volume of syringe

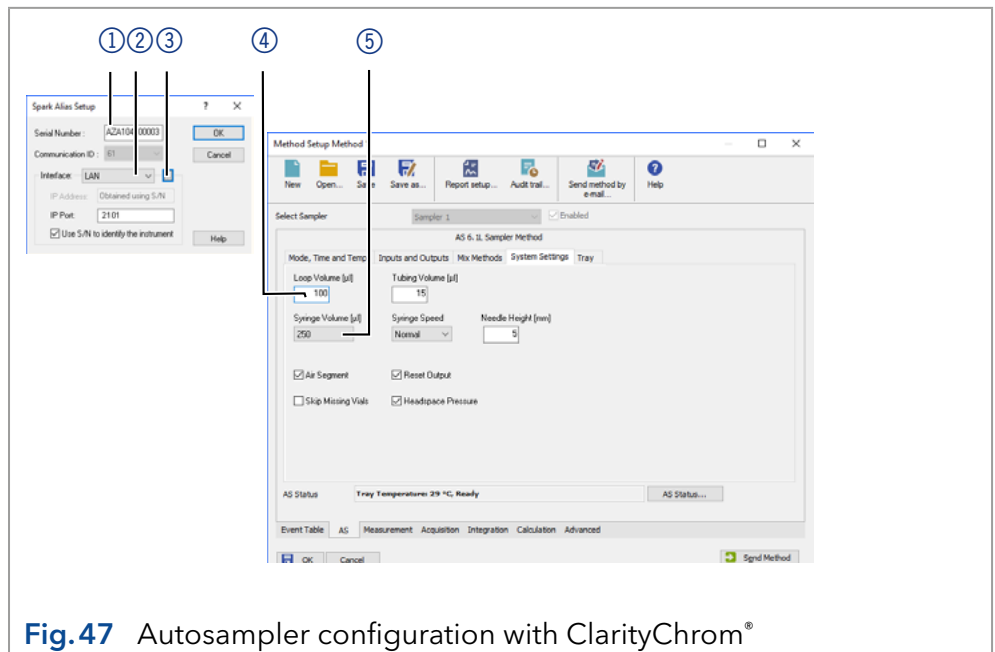

Fig.47 Autosampler configuration with ClarityChrom®

11.2 Autosampler device software

The Autosampler AS 6.1L Service Manager is included with the autosampler. Using this software, you can check and control the device. These settings can also be made with the chromatography software, so that it is not absolutely necessary to install the Service Manager.

11.3 Flushing the system

The system should be flushed before a column is connected. The flushing procedure using the Service Manager tool is described below.



Note: KNAUER recommends using a mixture of water and isopropanol (80 % : 20 %) or the mobile phase as the flushing solution.

The following steps are explained for when the Service Manager is used.

11.3.1 System flushing with Autosampler AS 6.1L Service Manager

1. Install Autosampler 6.1L Service manager.
2. Fill a bottle with degassed wash solution and place it in the respective holder inside the autosampler.
3. Introduce the suction tube for wash solution (right port of syringe valve, see. Fig. 44) into the bottle.
4. Start the Service Manager Tool and select the Direct Control menu (**Instrument** → **Maintenance** → **Direct Control**).
5. In the Syringe field, click **End**. One syringe volume is aspirated into the syringe through the wash solution tube.
6. In the Syringe field, click **Home**. The syringe content is emptied into the waste.
7. Repeat step 5 and 6 until the syringe and the suction tube have been filled completely.
8. In the Initial wash field, click **Start**. All tubes that are connected to the syringe are flushed.
9. In the Initial wash field click **Stop**, if all tubings are filled.
10. Click **Close** to exit the Direct Control window.

11.4 I/O connection

By default, the autosampler has an I/O connection that supports TTL inputs (low-active) and a closed-contact output. Devices without LAN connection that require a trigger signal for the injection can be connected by means of the I/O connection.

The TTL inputs allow you to control the autosampler using other devices and are defined using the instrument methods of the chromatography software.



Note: Only connect the autosampler to devices that fulfill the required safety standards!

11.4.1 Defining the TTL inputs

- Next Injection Input: The injection sequence is started. After ending the injection sequence, the autosampler waits for the next start signal.

- Freeze Input: The analysis time is paused. The autosampler runs the configured program up to the filling of the sample loop. The injection is not performed until the input is deactivated.
- Stop Input: Immediately halts the analysis.

11.4.2 Defining the closed-contact output

- Inject Marker: The closed-contact output is activated when the injection valve switches from LOAD to INJECT.
- Alarm: The closed-contact output is activated when there is an autosampler fault.
- Auxiliary: -

11.4.3 Configuration of I/O connection (9 pins)

Explanation	Cable color
1. Output, start injection	Red in three-conductor cable
2. Output, start injection	Black in three-conductor cable
3. Input 1, programmable input for stopping injections (low-active)	Red in four-conductor cable
4. Input 2, programmable input for stopping injections (low-active)	Black in four-conductor cable
5. Not occupied.	-
6. Output	Brown in three-conductor cable.
7. Not occupied.	-
8. Ground, for inputs 1 and 2	Orange in four-conductor cable
9. Ground, for inputs 1 and 2	Brown in four-conductor cable

12. Functionality tests



Note: Standard processes regarding IQ and OQ in single devices may be handled differently in individual cases.

12.1 Installation Qualification (IQ)

The customer may request the Installation Qualification, which is free of charge. In case of a request, the technical support of KNAUER or a provider authorized by KNAUER performs this functionality test during the installation.

The Installation Qualification is a standardized document that includes the following:

- confirmation of flawless condition at delivery
- check if the delivery is complete
- certification on the functionality of the device

You can either use the IQ document attached to this instruction manual or download a digital version from our website:



12.2 Operation Qualification (OQ)

The Operation Qualification includes an extensive functionality test according to KNAUER standard OQ documents. The Operation Qualification is a standardized document and free of charge. It is not part of the delivery. Please contact the technical support in case of a request.

The Operation Qualification includes the following:

- definition of customer requirements and acceptance terms
- documentation on device specifications
- device functionality check at installation site

Test intervals To make sure that the device operates within the specified range, you should test the device regularly. The test intervals depend on the usage of the device.

Execution The test can be carried out either by the technical support of KNAUER or by a provider authorized by KNAUER (for a fee). For further information visit our website:



13. Maintenance and care

13.1 Maintenance contract

The following maintenance work on the device may only be performed by KNAUER or a company authorized by KNAUER and is covered by a separate maintenance contract:

- Opening the device or removing housing parts.

DANGER

Electric shock

Danger of electric shock from voltage-carrying parts inside the device. The housing serves as a protective cover against voltages inside the device.

- Switch the device off before opening the device.
- Pull the power plug.

13.2 Which type of maintenance tasks may users perform on the device?

Users may perform the following maintenance tasks themselves:

- Regularly check for clogged capillaries - test back pressure without column.
- Exchanging the fuses
- Exchanging the air and sample needle
- Exchanging the injection valve
- Exchanging the sample loop
- Exchanging the rotor seals
- Exchanging the capillary and tubing

NOTICE

Electronic defect

Performing maintenance tasks on a switched on device can cause damage to the device.

- Switch off the device.
- Pull the power plug.



Note: If leaks occur on the capillary screw fittings after maintenance and proper assembly, do not tighten them further, but instead replace them with new connection capillaries.

13.3 System flushing

Procedure	Process
	1. Connect the autosampler to the power supply.
	2. Establish a connection to the PC.
	3. Start the Service Manager Tool and select the Direct Control menu (Instrument → Maintenance → Direct Control).
	4. Click Initialize to check whether the valve is correctly positioned at the Inject position.
	5. In the Initial Wash field, click Start to flush the system.
	6. In the Initial Wash field, click Stop to stop flushing the system.

13.4 Exchanging the fuses



Note: If the fuses blow repeatedly, consult with KNAUER Technical Support for replacements and help in identifying the cause.

Procedure	Process
	1. Switch off the autosampler and remove the power plug to completely disconnect the device from the power supply.
	2. Remove the fuses from the fuse box at the rear of the device.
	3. Insert new fuses (2 x 2.5 A).
	4. Plug in the power plug.

13.5 Exchanging the injection valve and rotor seal

- Regularly clean the rotor seal of the injection valve.
- Regularly replace the rotor seal (approx. once a year).

13.5.1 Removing the injection valve and rotor seal

Prerequisites	<ul style="list-style-type: none"> ▪ The device is switched off. ▪ All capillary connections, except the sample loop, are removed from the valve. During removal, consecutively loosen all screws by half a turn respectively, until they can be removed.
Tools	<ul style="list-style-type: none"> ▪ Phillips screwdriver ▪ Allen screwdriver, 3 mm

Process

1. Loosen the screws ① on both sides of the injection valve.
2. Remove the valve by pulling it towards you.

Figure

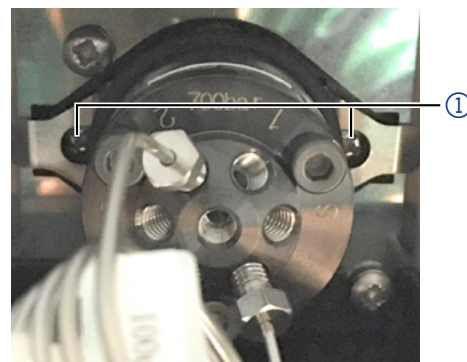

Fig.48 Removing the injection valve



Note: Note the position of the pin in the shaft of the removed valve!

Make sure the pin is in the same position when reinstalling the valve in the unit.



Fig.49 Note the position of the pin

3. Unscrew the 3 screws at the front of the valve ② with the allen wrench. Take care to consecutively loosen the screws by half a turn, until the tension of the spring assembly is released.
4. Lift the stator ③ when all three screws are removed.

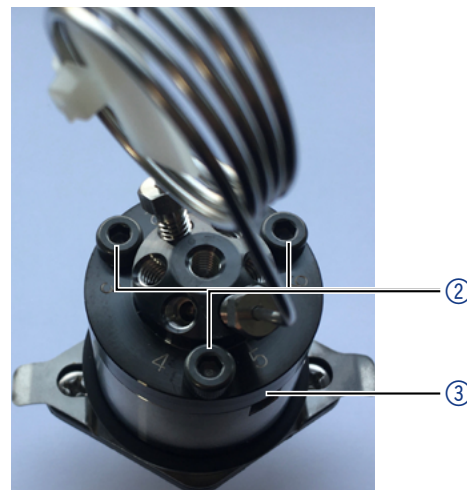

Fig.50 Removing the stator

5. Remove the rotor seal ④ from the rotor ⑤.
6. Clean or exchange the rotor seal (size and model of the rotor seal can vary, depending on the equipment of the autosampler).

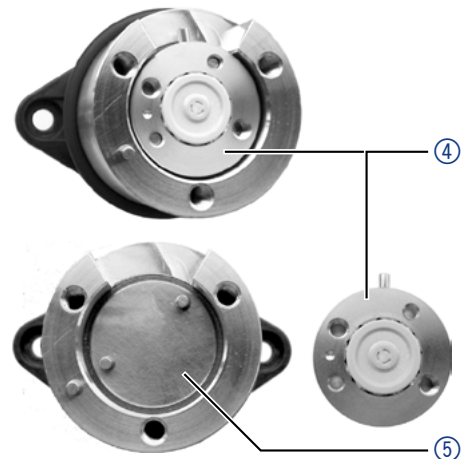

Fig.51 Remove the rotor seal

Reassembling the valve To reassemble the valve proceed in reverse order.

When reinstalling the valve into the autosampler make sure that ports 6 and 1 point upwards.

13.6 Replacing the sample loop

- When installing a sample loop with a different injection volume, make sure to use the correct combination of syringe and tubings and configure the control software accordingly. Also consider the maximum injection volume as given in section 8.3.
- Always connect the sample loop to ports 2 and 5 of the injection valve.

13.7 Exchanging the sample needle

- When using sample plates with 12, 48 or 108 sample vials, make sure that the needle height setting is >2 mm to prevent the needle from contacting the bottom of the sample vial.
- Tighten the screw fitting only until it is finger-tight to prevent the plastic capillary from becoming blocked.

Legend:

- ① Screw fitting
- ② Needle tubing
- ③ Nut
- ④ Sample needle

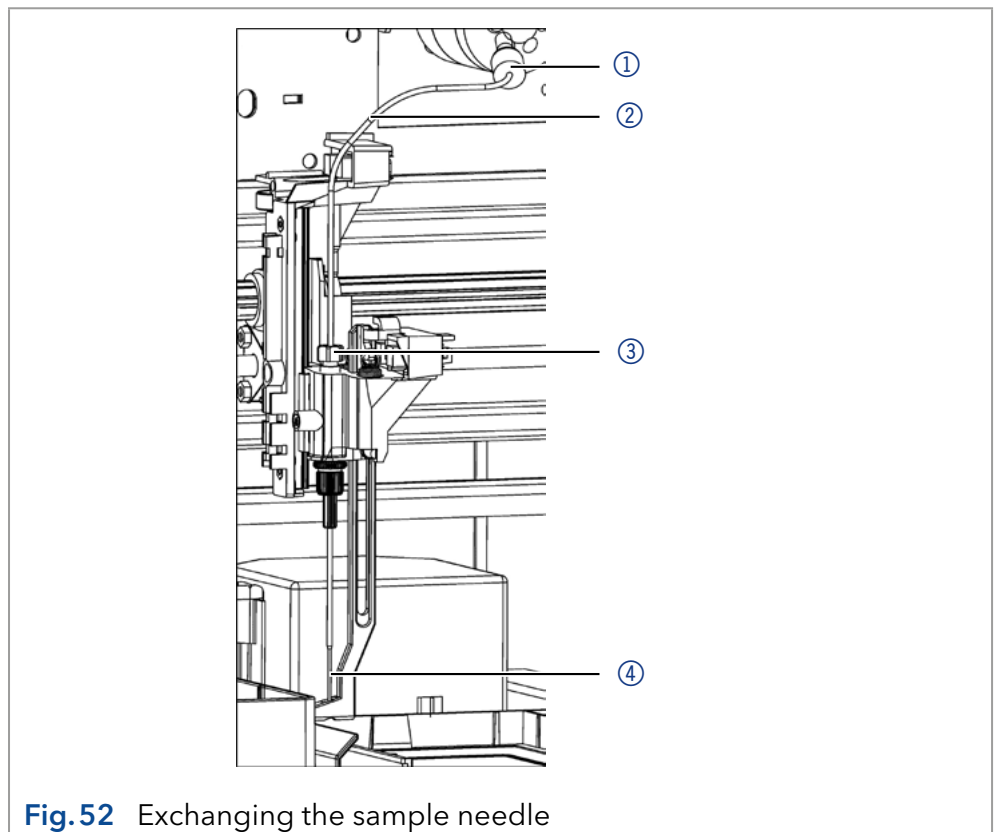

Fig.52 Exchanging the sample needle

- Procedure**
1. Start the Service Manager Tool and select the Direct Control menu (**Instrument → Maintenance → Direct Control**).
 2. In the Needle field, click **Exchange**. The needle moves to the replacement position.
 3. Loosen the union nut ③.
 4. Loosen the screw fitting ① of the needle tubing ② on the injection valve.
 5. Remove the sample needle ④ with the needle tubing.

6. Install a new sample needle unit. Make sure that the air seal fully surrounds the sample needle.
7. Fasten the sample needle with the union nut.
8. Fasten the needle tubing using the screw fitting on the injection valve.
9. In the Direct Control window, click **Initialize**. The needle moves to the initial position.
10. In the Initial Wash field, click **Start** to flush the system.
11. In the Initial Wash field, click **Stop** to stop flushing the system.
12. Click **Close** to exit the Direct Control window.

13.8 Exchanging the air needle

- When exchanging the air needle, make sure that the thread of the new height adjustment screw is flush with the lower edge of the retaining nut.
- Make sure that the sealing ring is located in the retaining nut.

Legend:

- ① Nut
- ② Retaining nut
- ③ Height adjustment screw
- ④ Air needle
- ⑤ Sample needle

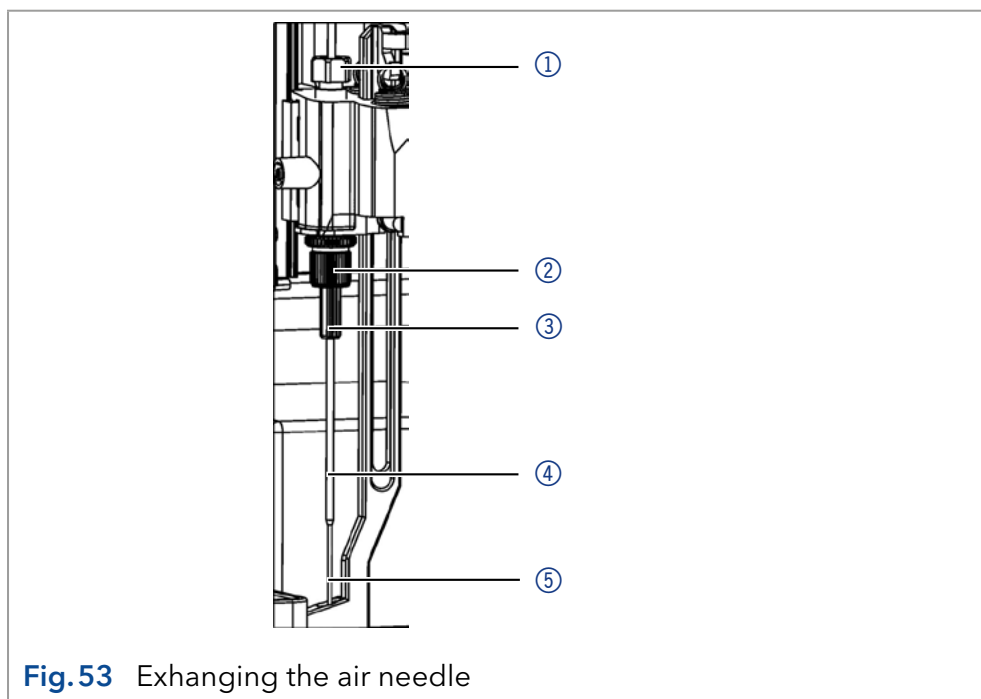

Fig.53 Exchanging the air needle

1. Start the Service Manager Tool and select the Direct Control menu (**Instrument → Maintenance → Direct Control**).
2. In the Needle field, click **Exchange**. The needle moves to the replacement position.
3. Loosen the union nut ①.
4. Loosen the screw fitting of the needle tubing on the injection valve.
5. Remove the sample needle ⑤ with the needle tubing
6. Loosen the retaining nut ② and pull it downwards together with the air needle ④.
7. Unscrew the retaining nut from the height adjustment screw ③.
8. Screw a new air needle with a new height adjustment screw into the retaining nut.
9. Screw in the retaining nut.

10. Insert the sample needle and fasten with the union nut.
11. Fasten the needle tubing using the screw fitting on the injection valve.
12. In the Direct Control window, click **Initialize**. The needle moves to the initial position.
13. In the Initial Wash field, click **Start** to flush the system.
14. In the Initial Wash field, click **Stop** to stop flushing the system.
15. Click **Close** to exit the Direct Control window.



Note: If you are also planning to replace the wash port, you can do this now, as all the relevant components are in the corresponding position (see chapter 13.12 on page 60).

13.9 Change of the syringe

By standard, the analytical autosamplers are equipped with a 250 μ l syringe. Use isopropanol as flushing solution to remove air bubbles from the new syringe.

Legend:

- ① Syringe valve
- ② Syringe
- ③ Syringe drive
- ④ Syringe plunger

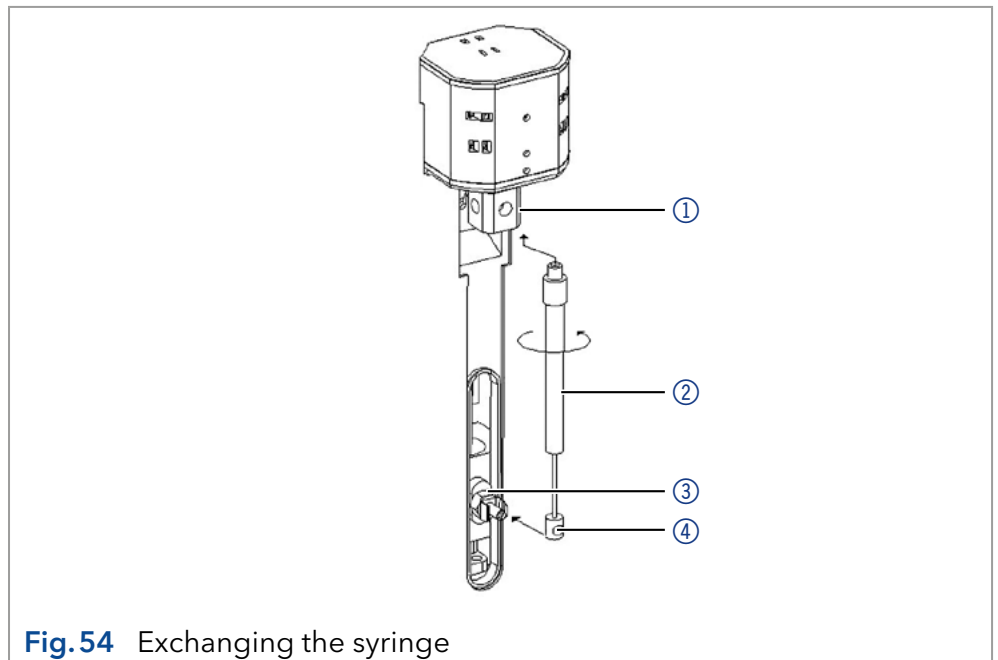

Fig.54 Exchanging the syringe

1. Start the Service Manager Tool and select the Direct Control menu (**Instrument** → **Maintenance** → **Direct Control**).
2. In the Syringe field, click **Exchange**. The syringe plunger is lowered.
3. Unscrew the syringe ② by rotating it counterclockwise.
4. Remove the syringe plunger ④ from the syringe drive ③ by pulling it towards you. Do not loose the screw of the syringe drive.
5. Fill new syringe with flushing solution.
6. Insert the syringe plunger into the syringe drive.
7. Tighten the syringe in the syringe valve by rotating it clockwise.
8. In the Syringe field, click **Home**. The syringe content is emptied into the waste.
9. If there is still air in the syringe, click **End** in the Syringe field. One syringe volume is aspirated into the syringe through the wash solution suction tube.

10. In the Syringe field, click **Home**. The syringe content is emptied into waste.
11. Slightly tap the body of the syringe if it still contains air. If necessary, repeat step 9 and 10. Repeat the step.
12. In the Initial Wash field, click **Start** to flush the system.
13. In the Initial Wash field, click **Stop** to stop flushing the system.
14. Click **Close** to exit the Direct Control window.

13.9.1 Exchanging the syringe plunger or plunger tip

1. Start the Service Manager Tool and select the Direct Control menu (**Instrument** → **Maintenance** → **Direct Control**).
2. In the Syringe field, click **Exchange**. The syringe plunger is lowered.
3. Remove the syringe (see chapter 13.9)
4. Pull the syringe plunger out of the glass cylinder of the syringe.
5. Use a pair of tweezers to remove the plunger tip.
6. Wet the new plunger tip with isopropanol.
7. Mount the new plunger tip onto the syringe plunger.
8. Push the syringe plunger into the glass cylinder of the syringe.
9. Install the syringe (see chapter 13.9).
10. In the Syringe field, click **Home**. The syringe content is emptied into the waste.

13.10 Syringe valve replacement

The syringe valve is subject to wear and tear and it has to be replaced periodically.

A worn out valve may cause a bad performance of the instrument.



Note: Place the syringe valve in Wash port 2 position before you replace the syringe valve. In this position, the mounting screws are opposite/in line with the holes.

Proceed as follows to replace the syringe valve:

Process

1. Open Alias Service Manager (ASM).
2. Go to Service mode:
Select **Instrument** > **Service** > **Service mode**.
3. Enter password: 101163

Figure

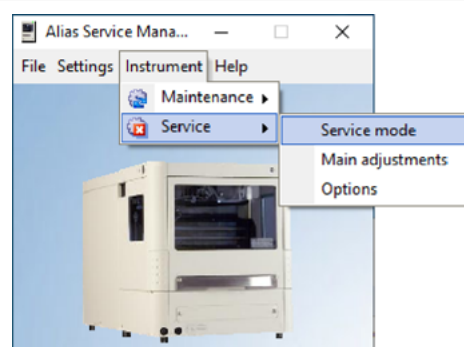

Process

4. Click **Exchange**. The syringe will move half way down.
5. Remove the syringe.

Figure

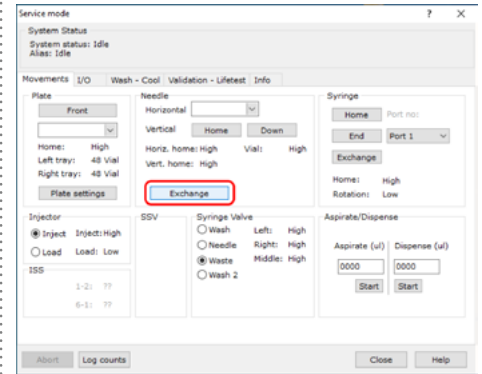

6. Select Syringe Valve position: **Wash 2**.



7. Remove all tubing from the syringe valve.
8. Loosen the lower socket-head screw ② a full rotation counter-clockwise.
9. Loosen the upper socket head screw ① a full rotation counter-clockwise.

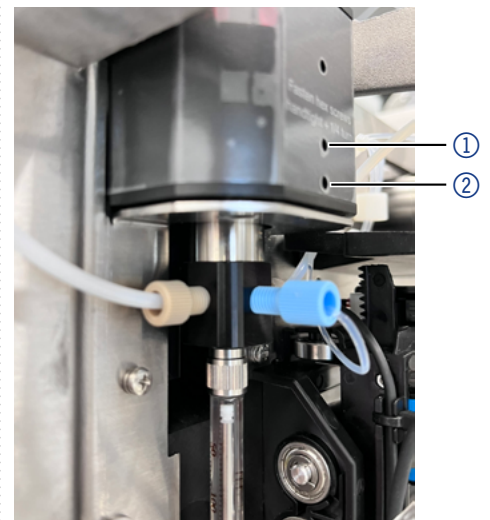

10. Disconnect the waste tubing ③ and remove the syringe valve ⑤.
11. Connect the waste tubing to the back of the new syringe valve.



Note: When installing the new syringe valve, the flat side ④ on the valve shaft should be facing forwards!

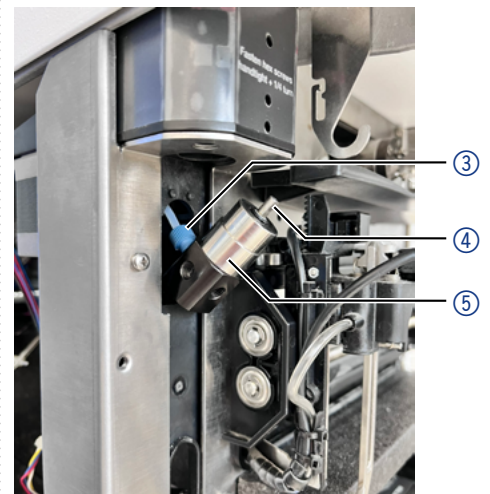

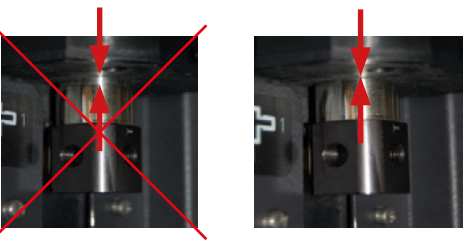
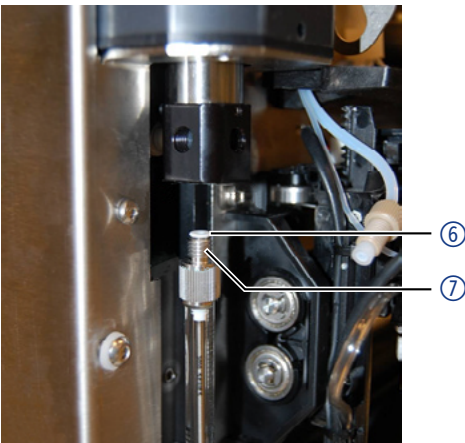
Process	Figure
<p>12. Make sure the valve is completely up when retightening the 2 socket head screws ① and ②.</p> <p>Note: Do not overtighten the screws! This might result in an unreparable syringe assembly (fingertight + 1/4 turn)!</p>	
<p>13. Install the syringe with a new Teflon seal as follows: Moisten the new seal ⑥ slightly with isopropanol, place it on the upper end ⑦ of the syringe, move the syringe carefully upwards into the syringe valve and tighten it by rotating it clockwise.</p> <p>14. Reconnect all tubing and initialize the instrument.</p>	

13.11 Replacing the buffer tubing

Legend:

- ① Loop
- ② Fitting on the injection valve
- ③ Screw
- ④ Loop holder
- ⑤ Fitting on the syringe valve

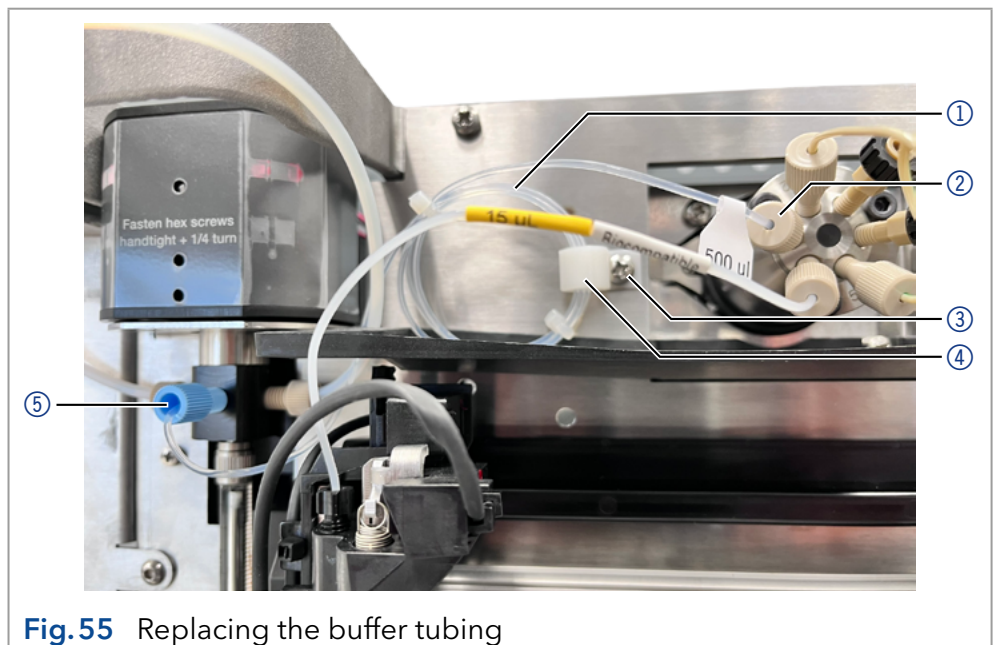

Tool Phillips screwdriver, PH1.

Procedure

1. Unscrew the fitting ⑤ on the syringe valve.
2. Unscrew the fitting ② on the injection valve (port 3).

Procedure**Process**

3. Loosen the screw ③ that secures the loop holder ④ to the housing.
4. Remove the loop ① from the loop holder.
5. Install the new buffer tubing in reverse order.

Result The buffer tubing has been replaced.

13.12 Replacing the wash port

Legend:

- ① Washport
- ② Screw

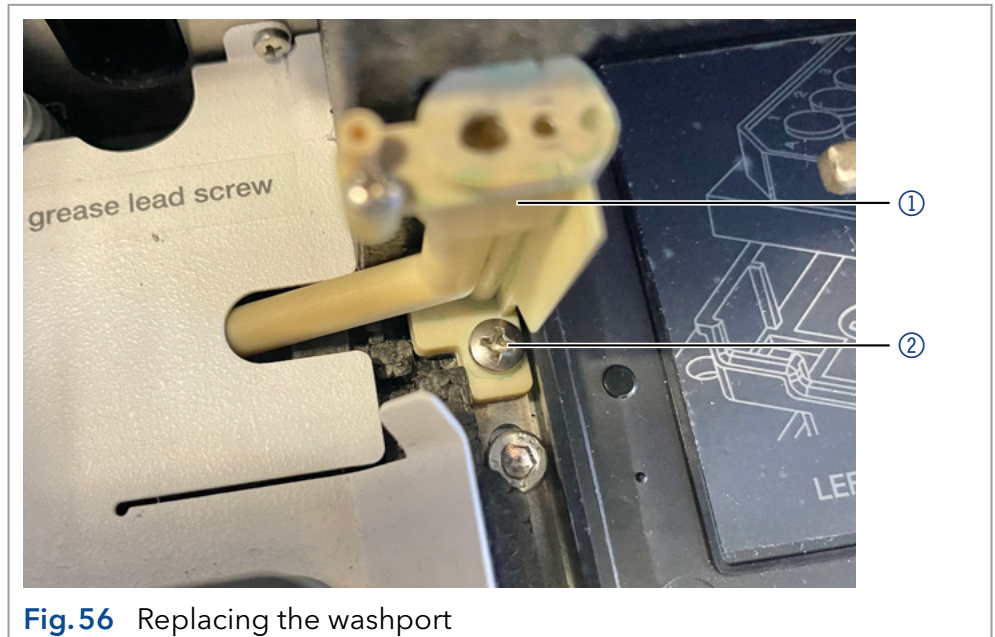
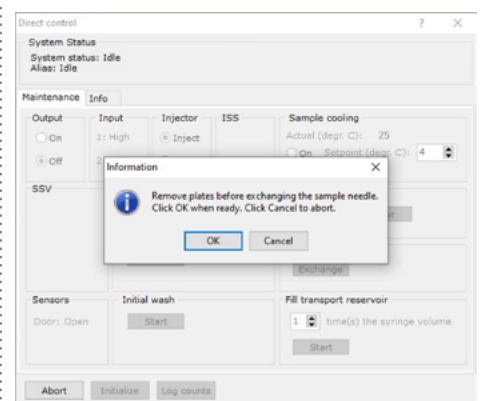

Fig.56 Replacing the washport

Tool Phillips screwdriver, PH1.

Procedure**Process**

1. Start the Alias Service Manager and select the Direct Control menu (**Instrument > Maintenance > Direct Control**).
2. In the Needle area, click **Exchange** and confirm with **<OK>**.
The needle moves to the position where it can be replaced.



3. Use the Philips screwdriver to loosen the screw ② that secures the washport ① and remove the washport (see Fig. 56).
4. Install the new washport.

Procedure

Process

- Click <OK> when the washport has been exchanged.
The needle moves back to the home position.

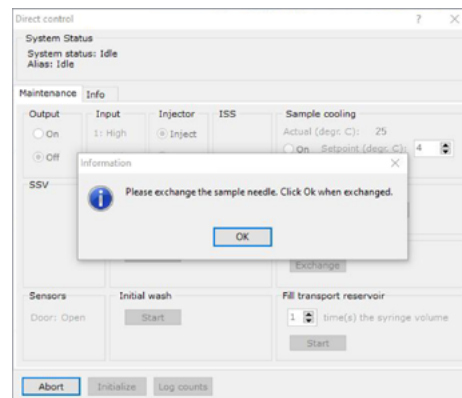

Note: Check that the needle is in the correct position after replacement. Correct the position of the needle with the Alias Service Manager if necessary.

Procedure

Process

- Open Alias Service Manager (ASM).
- Go to Main adjustments mode:
Select **Instrument > Service > Main adjustments**.
- Enter password: 101163

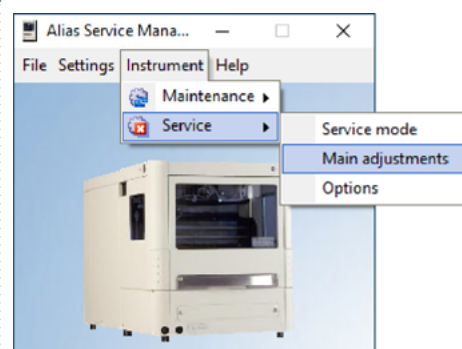

Legend:

- ① Adjustment buttons
- ② Correct needle position

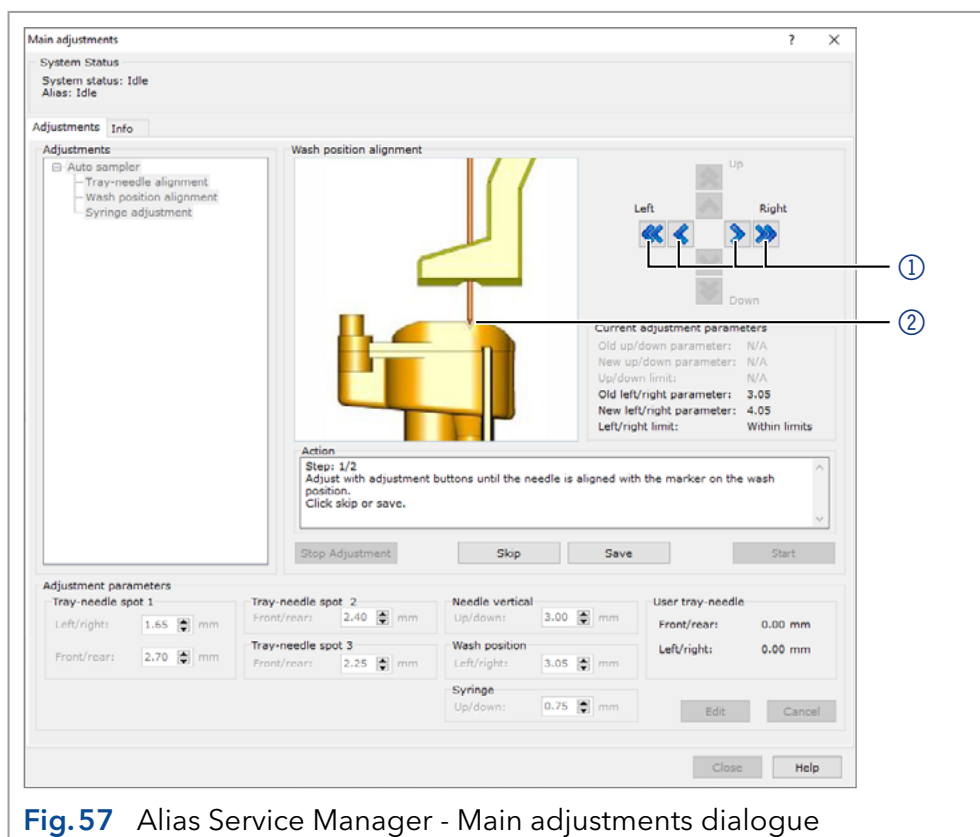





Fig.57 Alias Service Manager - Main adjustments dialogue

Procedure	Process
	<p>8. If the needle already is in correct position click <Skip>, <Finish> and <Close>, if not, proceed as follows.</p>
	<p>9. Click <Start> in the "Wash position alignment" area. The needle has to be aligned with the marker on the wash port (see illustration in the software).</p>
	<p>10. Use the adjustment buttons , ,  and  to align the needle.</p>
	<p>11. When the needle is in the correct position, click <Save>, <Finish> and <Close>.</p>

Result The washport has been replaced and the needle is in correct position.

13.13 Cleaning and caring for the device

All smooth surfaces of the device can be cleaned with a mild, commercially available cleaning solution, or with isopropanol.

- Clean collecting container and vial plates with a soft cloth.
- To remove deposits, flush the drainage tube regularly using solvent.

13.14 Putting the instrument out of operation

The device is designed for the usage of different solvents. Solvent residue can damage the device or irritate the skin. That is why we recommend to flush components of the flow path in the autosampler before maintenance.

Prerequisites The device has been flushed.

Procedure	Process
	<p>1. Switch off the autosampler.</p>
	<p>2. Pull the plug from the socket</p>
	<p>3. Remove the power cable from the device.</p>

Next Steps Conduct any allowed maintenance tasks. For storage, select a location according to the requirements, which are listed in the according chapter of this user manual.

14. Troubleshooting

14.1 Device errors

One possible cause of device errors is a malfunctioning valve.

14.1.1 Checking the valve

Remove the valve and check all parts for wear and contamination. Checking the valve implies that you remove and disassemble it and check rotor seal and stator for wear and dirt. After the problem has been eliminated and the valve reinstalled, flush the system as described in the section „Maintenance and care“.

14.2 LAN

Software faults can occur due to flawed communications between the devices or incorrect installation of the software.

- Procedure**
1. Check the cable connections.
 2. Start Autosampler AS 6.1L Service Manager.
 3. Start the Service Manager Tool and select the Direct Control menu (**Instrument → Maintenance → Direct Control**)
 4. In the Direct Control window, click **Initialize**.

Go through the following steps, in case no connection between the computer and the devices can be established. Check after each step if the problem is solved. If the problem cannot be located, call the Technical Support.

Check the status of the LAN connection in the Windows taskbar:



If no connection was established, test the following:

- Is the router switched on?
 - Is the patch cable connected correctly to the router and the computer?
5. Check the router settings:
 - Is the router set to DHCP server?
 - Is the IP address range sufficient for all the connected devices?
 6. Check all connections:
 - Are the patch cable connected to the LAN ports and not the WAN port?
 - Are all cable connections between devices and router correct?
 - Are the cables plugged in tightly?
 7. If the router is integrated into a company network, pull out the patch cable from the WAN port.
 - Can the devices communicate with the computer, even though the router is disconnected from the company network?

8. Turn off all devices, router, and computer. Turn on the router first and allow it to initialize. After the router is ready turn on the devices and the computer.
9. Replace the patch cable of the device to which no connection could be established.
10. Make sure that the IP port of the device matches the port in the chromatography software.

14.3 Analytical errors

Possible causes:

- Wear of parts
- Errors in injection and method settings
- Unsuitable combination of sample loop, buffer tubing and syringe.
- External effects such as temperature, and light-sensitive samples being exposed to light.

Solutions:

- Check whether the application has run previously without errors and that no changes have been made to the analytical system.
- Determine whether the fault is caused by the autosampler or other devices in the system.

If the required degree of reproducibility is not achieved, check the following possible sources of error and perform steps to eliminate them:

Cause of fault	Elimination
Air in liquid path	Perform an initial wash.
Leaking syringe	If the syringe is leaking at the top, check whether it has been installed correctly. If the syringe is leaking at the bottom, exchange the syringe plunger or complete syringe.
Leaking syringe valve	Check connections and retighten if required.
Rotor seal worn	Exchange the rotor seal and check the stator of the valve.
Dead volume in capillary connections	Install new fittings onto capillary connections.

If a blank run returns an excessively large peak, check the following possible causes of error and perform steps to eliminate them:

Cause of fault	Elimination
Solubility problems	Either modify sample or accept carryover.
Interaction between the sample and the hardware	Check hardware: <ul style="list-style-type: none"> ▪ Either use an additional wash of the needle (inside and outside) or install a different needle type (steel, coated steel). ▪ Capillaries and tubing: Use other connections between the autosampler and the columns (steel, PEEK) or other wash solutions.
Blank contaminated	Use new blank.
Cause unknown.	Attempt to solve problem by using different solvents.

If no injection is performed:

Cause of fault	Elimination
Liquid path blocked	<ol style="list-style-type: none"> 1. Disconnect the needle tubing of the needle from the injection valve. 2. Start system flushing. 3. If solvent flows out of the free port (port 4), check the needle. 4. If no solvent out of the free port (port 4), disconnect the buffer tubing from the injection valve (port 3). 5. Start system flushing. 6. If solvent flows out at the open end of the buffer tubing, check the rotor seal. 7. If no solvent flows out of the open end of the buffer tubing, disconnect it from the syringe valve. 8. Start system flushing. 9. If solvent flows out of syringe valve, check the buffer tubing and replace it if necessary. 10. If no solvent flows out of the syringe valve, check for over-tightened connections in the entire flow path and check the syringe valve.

Cause of fault	Elimination
Leaking valve	<ol style="list-style-type: none"> 1. Disconnect the needle and buffer tubings from the injection valve. 2. Connect the pump to port 1 of the injection valve and block port 6 with a blind plug. 3. Set the valve to LOAD position (initial position) and start the pump at a low flow rate. 4. Check ports 3 and 4 for leakage. <ul style="list-style-type: none"> ▪ If leakage occurs, check the rotor seal and stator. ▪ If no leakage occurs install new capillaries and check again.

14.4 System messages in OpenLAB®

The various system messages of the chromatography software OpenLAB® from KNAUER are explained below. The system messages are sorted alphabetically.

System message	Explanation
Autosampler is in run mode.	<ul style="list-style-type: none"> ▪ Quit the control software and restart. ▪ Switch the device off and on.
Autosampler is not responding. Check communication settings and ensure the device is online.	<ul style="list-style-type: none"> ▪ Switch the device off and on. Check the network settings. ▪ Inform the Technical Support of the manufacturer in case the system message repeats itself.
Cannot run autosampler.	<ul style="list-style-type: none"> ▪ Switch the device off and on. Check the network settings. ▪ Inform the Technical Support of the manufacturer in case the system message repeats itself.
Cannot set destination vial to (number).	Check parameters in control software and correct entry.
Cannot set first transport vial to (number).	Check parameters in control software and correct entry.
Cannot set last transport vial to (number).	Check parameters in control software and correct entry.
Cannot stop autosampler.	<ul style="list-style-type: none"> ▪ Check the network settings. ▪ Inform the Technical Support of the manufacturer in case the system message repeats itself.

System message	Explanation
Communication port for autosampler was not initialized. Check the configuration settings.	Switch the device off and on. Inform the Technical Support of the manufacturer in case the system message repeats itself.
Configuration settings do not match with the device. Run cannot start.	Check configuration and settings.
Destination position not reached.	Switch the device off and on. Inform the Technical Support of the manufacturer in case the system message repeats itself.
Deviation of more than ± 2 mm towards home.	<ul style="list-style-type: none"> ▪ Look for visible obstructions in area of vial plate. ▪ Check the belt tension of the vial plate.
Dispenser error.	Switch the device off and on. Inform the Technical Support of the manufacturer in case the system message repeats itself.
Electronics error.	Switch the device off and on. Inform the Technical Support of the manufacturer in case the system message repeats itself.
EEPROM error in adjustments.	Switch the device off and on. Inform the Technical Support of the manufacturer in case the system message repeats itself.
EEPROM error in log counter.	Switch the device off and on. Inform the Technical Support of the manufacturer in case the system message repeats itself.
EEPROM error in settings.	Switch the device off and on. Inform the Technical Support of the manufacturer in case the system message repeats itself.
EEPROM write error.	Switch the device off and on. Inform the Technical Support of the manufacturer in case the system message repeats itself.
Error 369	Not enough transport liquid in store. Refill transport liquid.
Error 370	Not enough reagent in store. Refill reagent.
Error by setting Mix&Dilute vials.	Switch the device off and on. Inform the Technical Support of the manufacturer in case the system message repeats itself.
Error occurred during initialization, the Autosampler AS 6.1L cannot start.	Switch the device off and on. Inform the Technical Support of the manufacturer in case the system message repeats itself.
Error resetting output.	Switch the device off and on. Inform the Technical Support of the manufacturer in case the system message repeats itself.
Error running user defines program.	Switch the device off and on. Inform the Technical Support of the manufacturer in case the system message repeats itself.

System message	Explanation
Error setting injection mode.	Switch the device off and on. Inform the Technical Support of the manufacturer in case the system message repeats itself.
Error setting needle height.	Switch the device off and on. Inform the Technical Support of the manufacturer in case the system message repeats itself.
Error setting syringe speed.	Switch the device off and on. Inform the Technical Support of the manufacturer in case the system message repeats itself.
Error setting the analysis time.	Switch the device off and on. Inform the Technical Support of the manufacturer in case the system message repeats itself.
Error setting the auxiliaries.	Switch the device off and on. Inform the Technical Support of the manufacturer in case the system message repeats itself.
Error setting the flush volume.	Switch the device off and on. Inform the Technical Support of the manufacturer in case the system message repeats itself.
Error setting the injection volume.	Switch the device off and on. Inform the Technical Support of the manufacturer in case the system message repeats itself.
Error setting the loop volume.	Switch the device off and on. Inform the Technical Support of the manufacturer in case the system message repeats itself.
Error setting the prep. mode.	Switch the device off and on. Inform the Technical Support of the manufacturer in case the system message repeats itself.
Error setting the syringe volume.	Switch the device off and on. Inform the Technical Support of the manufacturer in case the system message repeats itself.
Error setting timed events.	Switch the device off and on. Inform the Technical Support of the manufacturer in case the system message repeats itself.
Error setting the tray configuration.	Switch the device off and on. Inform the Technical Support of the manufacturer in case the system message repeats itself.
Error setting the tray temperature.	Switch the device off and on. Inform the Technical Support of the manufacturer in case the system message repeats itself.
Error setting the vial number.	Switch the device off and on. Inform the Technical Support of the manufacturer in case the system message repeats itself.
Error setting tubing volume.	Switch the device off and on. Inform the Technical Support of the manufacturer in case the system message repeats itself.

System message	Explanation
Error setting wash volume.	Switch the device off and on. Inform the Technical Support of the manufacturer in case the system message repeats itself.
Flush volume error.	Check parameters in control software and correct entry.
Home sensor activated when not expected.	<ul style="list-style-type: none"> ▪ Check parameters in control software and correct entry. ▪ Switch the device off and on. Inform the Technical Support of the manufacturer in case the system message repeats itself.
Home sensor not de-activated.	<ul style="list-style-type: none"> ▪ Check whether there are visible obstructions impairing the vial plate. ▪ Switch the device off and on. Inform the Technical Support of the manufacturer in case the system message repeats itself.
Home sensor not reached.	<ul style="list-style-type: none"> ▪ Check whether there are visible obstructions impairing the vial plate. ▪ Switch the device off and on. Inform the Technical Support of the manufacturer in case the system message repeats itself.
Horizontal: Home sensor activated when not expected.	Switch the device off and on. Inform the Technical Support of the manufacturer in case the system message repeats itself.
Horizontal: Home sensor not de-activated.	<ul style="list-style-type: none"> ▪ Check whether there are visible obstructions impairing the needle unit. ▪ Switch the device off and on. Inform the Technical Support of the manufacturer in case the system message repeats itself.
Horizontal: Home sensor not reached.	<ul style="list-style-type: none"> ▪ Check whether there are visible obstructions impairing the needle unit. ▪ Switch the device off and on. Inform the Technical Support of the manufacturer in case the system message repeats itself.
Horizontal: Needle position is unknown.	Initialize the needle unit using the control software.
Illegal sensor readout.	Switch the device off and on. Inform the Technical Support of the manufacturer in case the system message repeats itself.
Incorrect first destination vial.	Check parameters in control software and correct entry.
Injection needle unit error.	<ul style="list-style-type: none"> ▪ Check whether there are visible obstructions impairing the needle unit. ▪ Switch the device off and on. Inform the Technical Support of the manufacturer in case the system message repeats itself.

System message	Explanation
Injection valve or ISS unit error.	Switch the device off and on. Inform the Technical Support of the manufacturer in case the system message repeats itself.
Injection volume (number) is invalid. For specified injection method, volume should be within the range $\%.2f \mu\text{l}-\%.2f \mu\text{l}$, with (number). μl increments.	Check parameters in control software and correct entry.
Injection volume error.	Check parameters in control software and correct entry.
Invalid (number) vial position (number). The vial position must be between 01 and (number).	Check parameters in control software and correct entry.
Invalid combination of the trays. The combination of different trays for the Mix&Dilute mode is not allowed.	<ul style="list-style-type: none"> ▪ Insert the correct vial plate. ▪ Check parameters in control software and correct entry.
Invalid combination of the trays. The combination of plates 384 low and 96 high is not allowed.	<ul style="list-style-type: none"> ▪ Insert the correct vial plate. ▪ Check parameters in control software and correct entry.
Invalid configuration. ISS option not installed on autosampler. Switch off this option in configuration dialog.	Check parameters in control software and correct entry.
Invalid configuration. SSV option not installed on autosampler. Switch off this option in configuration dialog.	Check parameters in control software and correct entry.
Invalid flush volume (number) μl . The flush volume should be between 0 and (number) μl .	Check parameters in control software and correct entry.
Invalid instrument is detected.	Check parameters in control software and correct entry.
Invalid loop volume (number) μl . The loop volume should be between 0 and (number) μl .	Check parameters in control software and correct entry.

System message	Explanation
Invalid mix program: no Destination vial is specified in the configuration dialog.	Check parameters in control software and correct entry.
Invalid mix program: No Reagent A vial is specified in the configuration dialog.	Check parameters in control software and correct entry.
Invalid mix program: No Reagent B vial is specified in the configuration dialog.	Check parameters in control software and correct entry.
Invalid mix times. The time should be between 1 and 9.	Check parameters in control software and correct entry.
Invalid needle height (number) mm. The needle height should be between (number) and (number) mm.	Check parameters in control software and correct entry.
Invalid time-based method. Several AUX events have the same time.	Check parameters in control software and correct entry.
Invalid time-based method. Several SSV events have the same time.	Check parameters in control software and correct entry.
Invalid tray temperature (number) °C. The temperature should be between 4 and 22 °C.	Check parameters in control software and correct entry.
Invalid loop volume (number) µl. The loop volume should be between 0 and (number) µl.	Check parameters in control software and correct entry.
Invalid wait time. The time should be between 0 and 9 h 50 min 59 sec. Invalid wash volume (number) µl. The loop volume should be between 0 and (number) µl.	Check parameters in control software and correct entry.
Invalid loop volume (number) µl. The volume should be between the 0 and the syringe volume (%d µl).	Check parameters in control software and correct entry.

System message	Explanation
ISS valve error.	Switch the device off and on. Inform the Technical Support of the manufacturer in case the system message repeats itself.
Missing destination vial.	<ul style="list-style-type: none"> ▪ Check position of sample vial. ▪ Check parameters in control software and correct entry.
Missing reagent vial.	<ul style="list-style-type: none"> ▪ Check position of sample vial. ▪ Check parameters in control software and correct entry.
Missing transport vial.	<ul style="list-style-type: none"> ▪ Check position of sample vial. ▪ Check parameters in control software and correct entry.
Needle movement error.	<ul style="list-style-type: none"> ▪ Check position of needle unit. ▪ Switch the device off and on.
Missing vial.	<ul style="list-style-type: none"> ▪ Check position of needle unit. ▪ Switch the device off and on.
No destination vial is specified in the configuration.	Check parameters in control software and correct entry.
No reagent A vial is specified in the configuration.	Check parameters in control software and correct entry.
No reagent B vial is specified in the configuration.	Check parameters in control software and correct entry.
No user defined or mix program is running.	Check parameters in control software and correct entry.
Not enough reagent liquid.	Check volume of liquid and change as required.
Not enough transport liquid available due to missing transport vials.	Check volume of liquid and change as required.
Specify inject marker or AUX event to be able to trigger the run.	Check parameters in control software and correct entry.
Selecting transport position failed.	Switch the device off and on. Inform the Technical Support of the manufacturer in case the system message repeats itself.
Serial number is not valid. Check the configuration.	Check parameters in control software and correct entry.
Setting mix program error.	Switch the device off and on. Inform the Technical Support of the manufacturer in case the system message repeats itself.
Setting service mode failed.	Switch the device off and on. Inform the Technical Support of the manufacturer in case the system message repeats itself.

System message	Explanation
Syringe dispenser unit error.	Switch the device off and on. Inform the Technical Support of the manufacturer in case the system message repeats itself.
Syringe home sensor not de-activated.	<ul style="list-style-type: none"> ▪ Needle flushing with control software. ▪ Switch the device off and on. Inform the Technical Support of the manufacturer in case the system message repeats itself.
Syringe home sensor not reached.	<ul style="list-style-type: none"> ▪ Needle flushing with control software. ▪ Switch the device off and on. Inform the Technical Support of the manufacturer in case the system message repeats itself.
Syringe position is unknown.	Initialize the syringe unit using the control software.
Syringe rotation error.	<ul style="list-style-type: none"> ▪ Needle flushing with control software. ▪ Switch the device off and on. Inform the Technical Support of the manufacturer in case the system message repeats itself.
Syringe valve did not find destination position.	<ul style="list-style-type: none"> ▪ Needle flushing with control software. ▪ Switch the device off and on. Inform the Technical Support of the manufacturer in case the system message repeats itself.
Temperature above 48 °C at cooling ON.	<ul style="list-style-type: none"> ▪ Switch off the cooling and check whether ambient temperature sensor is properly functioning. ▪ Inform the Technical Support of the manufacturer in case the system message repeats itself.
ISS option not installed on autosampler. Switch off ISS-B option in configuration dialog.	Check control software configuration and correct entry.
The autosampler is not ready. Try again later.	Switch the device off and on. Inform the Technical Support of the manufacturer in case the system message repeats itself.
The injection volume of (number) µl is invalid. For the specified injection method, volume should equal (number) µl.	Check parameters in control software and correct entry.
Tray error.	Check parameters in control software and correct entry.
Valve error.	Check parameters in control software and correct entry.

System message	Explanation
Vertical: Home sensor not de-activated.	<ul style="list-style-type: none"> ▪ Check whether there are visible obstructions impairing the needle unit. ▪ Switch the device off and on. Inform the Technical Support of the manufacturer in case the system message repeats itself.
Vertical: Home sensor not reached.	<ul style="list-style-type: none"> ▪ Check whether there are visible obstructions impairing the needle unit. ▪ Switch the device off and on. Inform the Technical Support of the manufacturer in case the system message repeats itself.
Vertical: Needle position is unknown.	Initialize the instrument in the control software.
Vertical: Stripper did not detect plate (or wash/waste). Missing vial.	<ul style="list-style-type: none"> ▪ Check sample vial and plate. ▪ Switch the device off and on. Inform the Technical Support of the manufacturer in case the system message repeats itself.
Vertical: Stripper stuck.	Switch the device off and on. Inform the Technical Support of the manufacturer in case the system message repeats itself.
Vertical: The sample needle arm is at an invalid position.	Switch the device off and on. Inform the Technical Support of the manufacturer in case the system message repeats itself.
Wear-out limit reached.	Switch the device off and on. If the system message appears again, notify KNAUER Technical Support. The valve has to be replaced.
Wrong tubing volume. The largest tubing volume for standard injections is 200 µl.	Check parameters in control software and correct entry.

15. Technical data

15.1 Main features

Max. plate/vial height	47 mm (incl. septa or capmat)
Headspace pressure	Built-in compressor, only for sample vials with septum
Switching time inj. valve	< 100 ms
Piercing needle precision	± 0.6 mm
Sample carrier cooling / -heating	With cooling/heating function 4 - 40 °C (±2 °C at range limits)
Vial detection	Missing vial/well plate detection by sensor
Needle flushing	Programmable: wash between injections and wash between vials
Injection precision	RSD (Relative Standard Deviation): <ul style="list-style-type: none"> ▪ Full loop filling < 0.3 % ▪ Partial loop filling at injection volumes > 5 µl: < 0.5 % ▪ µl pickup at injection volumes > 5 µl: < 1.0 %
Injections per vial	max. 9 injections
Injection cycle time	Min. 7 s from the same vial, 14 s from different vials; < 60 s for 100 µl sample injection in all injection modes, incl. 300 µl needle wash.
Analysis time	Max. 9 h, 59 min, 59 s

15.2 Device variants

	Analytical	Bio	Preparative
Sample capacity	Max. 768 samples (microtiter plates) or 108 x 1.5 ml vials	Max. 768 samples (microtiter plates) or 108 x 1.5 ml vials	Max. 30 x 10 ml vials
Injection volume range	0.1 µl - 5000 µl	0.1 µl - 5000 µl	1 - 10000 µl
Injection mode	Full loop, Partial loop, µl pickup	Full loop, Partial loop, µl pickup	Partial loop

	Analytical	Bio	Preparative
Sample carryover	< 0.01 % under typical conditions using needle wash; < 0.005 % under special conditions with extended needle wash	< 0.01 % under typical conditions using needle wash; < 0.005 % under special conditions with extended needle wash	< 0.1 % under typical conditions using needle wash
Wetted parts	Stainless steel, ETFE, Vespel, Kel-F, glass, PTFE	Silica-coated stainless steel, PEEK, ETFE, Kel-F, glass, PTFE	Stainless steel, ETFE, PEEK, Kel-F, glass, PTFE

15.3 Communication

Interfaces	LAN
Control	Ethernet (LAN), analog
Inputs	2 programmable TTL inputs (next injection, freeze, stop)
Outputs	1 programmable relay output (inject marker, auxiliary, alarm)

15.4 General

Energy demand	95 - 240 V AC \pm 10 %, 50 - 60 Hz
Energy consumption	200 VA
Dimensions (width \times height \times depth)	<ul style="list-style-type: none"> ▪ Standard: 364 x 379 x 567 mm ▪ Cool/Heat: 364 x 379 x 623 mm
Weight	<ul style="list-style-type: none"> ▪ Standard: 28 kg ▪ Cool/Heat: 30 kg
Stackable weight (Maximum resting weight)	65 kg
Leak sensor	None
Ambient conditions	<ul style="list-style-type: none"> ▪ Temperature range: 10 - 40 °C; 50 - 104 °F ▪ Air humidity: 20 - 80 % ▪ Max. operating altitude: 2000 m above sea level
Area of use	For indoor use only.
Overvoltage category	II
Pollution degree	2
Storage conditions	-29 °C to +60°C Max. 85 % humidity

16. Repeat orders

The list of repeat orders is current at the time of publication. Deviations are possible at later date.

Use the included packing list for repeat orders of spare parts. If there are any questions concerning repeat orders, contact the Technical Support.

	Name	Order number
Device	AZURA® Autosampler AS 6.1L, Basic, 1000 bar	AAA50AA
	AZURA® Autosampler AS 6.1L, Basic cool/heat, 1000 bar	AAA51AA
	AZURA® Autosampler AS 6.1L, Basic, 1240 bar	AAA10AA
	AZURA® Autosampler AS 6.1L, cool/heat, 1240 bar	AAA11AA
	AZURA® Autosampler AS 6.1L, Bio	AAA20AA
	AZURA® Autosampler AS 6.1L, Bio cool/heat	AAA21AA
	AZURA® Autosampler AS 6.1L, Prep	AAA40AA
	AZURA® Autosampler AS 6.1L, Prep cool/heat	AAA41AA
Vial plate	AZURA® Autosampler AS 6.1L, Prep-Bio cool/heat	AAA31AA
	Vial plate for 48 x 1,5 ml vials	A50050
	Vial plate for 84 x 1.5 ml + 3x 10 ml vials	A500501
	Vial plate for 12 x 10 ml vials	A500502
	Vial plate for 108 x 1.5 ml vials	A500505
Vial kits for analytical & preparative HPLC	Vial plate for 30 x 10 ml vials	A500507
	Screw neck vial set 1.5 ml (N9), clear glass, silicone septum, 100 pcs.	A0638-6
	Screw neck vial set 1.5 ml (N9), amber glass, silicone septum, 100 pcs.	A0638-7
	Screw neck vial set 1.5 ml (N9), clear glass, rubber septum, 100 pcs.	A0638-8
	Screw neck vial set 1.5 ml (N9), amber glass, rubber septum, 100 pcs.	A0638-9
	0.1 ml Microinserts for screw neck vials (N9), 100 pcs.	A18201-3
	Screw neck vial set 10 ml (N18), clear glass, rubber septum, 100 pcs.	A15854
Sample loops	10 µl sample loop incl. fittings, stainless steel	A50078
	100 µl sample loop incl. fittings, stainless steel	A50077
	10 ml sample loop incl. fittings, stainless steel	A500509
	100 µl sample loop incl. fittings, PEEK	A500510
	10 ml sample loop incl. fittings, PEEK	A500511

	Name	Order number
Syringes	250 µl syringe	A500512
	500 µl syringe	A500513
	2500 µl syringe	A500514
Sample needle	Sample needle (stainless steel) with tubing (15 µl) incl. fitting	A64700
	Sample needle (stainless steel) with tubing (60 µl) incl. fitting	A500516
	Sample needle (coated stainless steel, biocompatible) with tubing (15 µl) incl. fitting	A500517
	Sample needle (coated stainless steel, biocompatible) with tubing (60 µl) incl. fitting	A500518
Air needles	50 mm air needle, yellow	A500529
	56 mm air needle, red	A500530
	62 mm air needle, nature	A50058
	68 mm air needle, blue	A500531
	74 mm air needle, green	A500532
	80 mm air needle, black	A500533
	Air needle set, incl. 1 pc. of each type	A50059
Rotor seals	Rotor seal (Vespel) for 700 bar valve (spare part for AAA00AA, AAA01AA)	A500519
	Rotor seal (Vespel) for 1000 bar valve (spare part for AAA50AA, AAA51AA)	A500520
	Rotor seal (Vespel) for 1240 bar valve (spare part for AAA10AA, AAA11AA)	A500521
	Rotor seal (PEEK) for 345 bar valve (spare part for AAA20AA, AAA21AA)	A500522
	Rotor seal (PEEK) for 350 bar valve (spare part for AAA40AA, AAA41AA)	A500523
	Rotor seal (PEEK) for 200 bar valve (spare part for AAA31AA)	A500524
Buffer tubings	500 µl buffer tubing incl. fittings	A500525
	1000 µl buffer tubing incl. fittings	A500526
	2000 µl buffer tubing incl. fittings	A500527
Optional accessories	2.5 A fuse, 2 pcs.	A500534
	Wash bottle, rectangular, 250 ml	A500535
	Waste tube (8 mm ID x 12 mm OD), silicone, 1 m	A500536
	Waste tube (8 mm ID x 9.5 mm OD), PTFE, 1 m	A500537

17. Transport and storage

Regarding the following information, carefully prepare the device for transport or storage.

17.1 Taking the device out of operation

Prerequisites The device is switched off.

Procedure

Process

1. Pull the power plug out of the socket and then out of the device.
2. Pack the power cable together with the device.

Next steps Disconnect all electrical connections. Remove the accessories and pack the device for transport or storage.

17.2 Packing the device

- Original packaging: Ideally you should use the original transport packaging.
- Lifting: Grab the device around the center of both sides and lift it into the packaging. Do not hold onto front cover, as it is loosely attached to the device.

17.3 Transporting the device

- Documents: If you want to return your device to KNAUER for repairs, enclose the „[Service request form and decontamination report](#)“ which can be downloaded from our website.
- Device data: For a secure transport, note the weight and dimensions of the device (see chapter “Technical data” on page 75).

17.4 Storing the device

- Flushing solution: Pay attention that all hoses and capillaries have been emptied or filled with flushing solution (e. g. isopropanol) before storage. To prevent algae formation, do not use pure water.
- Seals: Close all inputs and outputs with cap fittings.
- Ambient conditions: The device can be stored under ambient conditions which are listed in the Technical data (see page 75).

18. Disposal

Hand in old devices or disassembled old components at a certified waste facility, where they will be disposed of properly.

18.1 AVV-Marking Germany

According to the German "Abfallverzeichnisverordnung" (AVV) (January, 2001), old devices manufactured by KNAUER are marked as waste electrical and electronic equipment: 160214.

18.2 WEEE registration number

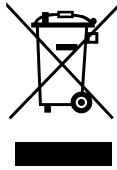

All WEEE registrations of KNAUER and the corresponding categories can be viewed on our website: www.knauer.net/imprint

All dealers and importers of KNAUER devices are responsible for the disposal of old devices in accordance with the WEEE Directive. KNAUER devices may not be disposed of with household waste.

For devices purchased directly from KNAUER, KNAUER will bear the costs of disposal. In all other cases, the respective dealer is obliged to bear the disposal costs. Get in touch with your contact person for further information on disposal.

If it is necessary to ship the old device, you will bear the shipping costs.

18.3 Eluents and other operating materials

All eluents and other operating materials have to be collected separately and disposed of properly.

All wetter components of a device, e. g. flow cells of detectors or pump heads and pressure sensors for pumps, have to be flushed with isopropanol first and water afterwards before being maintained, disassembled or disposed.

19. Chemical compatibility of wetted materials



Note: The user takes the responsibility for using the fluids and chemicals in an appropriate and safe way. If there is any doubt, contact the Technical Support of the manufacturer.

19.1 General

The device is very resistant against a variety of commonly used eluents. However, make sure that no eluents or water come in contact with the device or enter into the device. Some organic solvents (such as chlorinated hydrocarbons, ether) may cause coating damage or loosen glued components by improper handling. Even small quantities of other substances, such as additives, modifiers, or salts can influence the durability of the materials. Exposure time and concentration have a high impact on the resistance.

The following list contains information about the chemical compatibility of all wetted materials which are used in devices made by KNAUER. The data bases on a literature research on the manufacturer specifications of the materials. The wetted materials of this device are listed in the chapter "Technical data".

All resistances mentioned here are for use at temperatures up to 40 °C, unless stated otherwise. Please note that higher temperatures can significantly affect the stability of different materials.

19.2 Plastics

Polyetheretherketone (PEEK)

PEEK is a durable and resistant plastic and, next to stainless steel, the standard material in HPLC. It can be used at temperatures up to 100 °C and is highly chemical resistant against almost all commonly used solvents in a pH range of 1 - 12.5. PEEK is potentially moderate resistant against oxidizing and reducing solvents.

Therefore, following solvents should not be used: Concentrated and oxidizing acids (such as nitric acid solution, sulfuric acid), halogenated acids (such as hydrofluoric acid, hydrobromic acid) and gaseous halogens. Hydrochloric acid is approved for most applications.

In addition, following solvents can have a swelling effect and may have an impact on the functionality of the built-in components: Methylene chloride, THF and DMSO in any concentration such as acetonitrile in higher concentrations.

Polyethylene terephthalate (PET, outdated PETP)

PET is a thermoplastic and semi-crystalline material with high wear resistance. It is resistant against diluted acids, aliphatic and aromatic hydrocarbons, oils, fats and alcohols, but not against halogenated hydrocarbons and ketones. Since PET belongs chemically to esters, it is not compatible with inorganic acids, hot water and alkalis. Maximum operating temperature: up to 120 °C.

Polyimide (Vespel®)

This material is wear-resistant and permanent resilient thermally (up to 200 °C) as well as mechanically. It is chemically broadly inert (pH range 1-10) and is especially resistant against acidic to neutral and organic solvents, but vulnerable to pH strong chemical or oxidizing environments: It is incompatible with concentrated mineral acids (such as sulfuric acid), glacial acetic acid, DMSO and THF. In addition, it will be disintegrated by nucleophilic substances like ammonia (such as ammonium salts under alkaline conditions) or acetate.

Ethylene-tetrafluorethylene copolymer (ETFC, Tefzel®)

This fluorinated polymer is highly resistant against neutral and alkaline solvents. Some chlorinated chemicals in connection with this material should be handled with care. Maximum operating Temperature is 80 °C.

Perfluorethylenpropylen-Copolymer (FEP), Perfluoralkoxy-Polymer (PFA)

These fluorinated polymers hold similar features as PTFE, but with a lower operation temperature (up to 205 °C). PFA is suitable for ultrapure applications, FEP can be used universally. They are resistant against almost all organic and inorganic chemicals, except elemental fluorine under pressure or at high temperatures and fluorine-halogen compounds.

Polyoxymethylene (POM, POM-H-TF)

POM is a semi-crystalline, high-molecular thermoplastic material which stands out due to its high stiffness, low friction value and thermic stability. It can even substitute metal in many cases. POM-H-TF is a combination of PTFE fibres and acetal resin and is softer and has better slip properties as POM. The material is resistant against diluted acids (pH > 4) as well as diluted lyes, aliphatic, aromatic and halogenated hydrocarbons, oils and alcohols. It is not compatible with concentrated acids, hydrofluoric acid and oxidizing agent. Maximum operating temperature is 100 °C.

Polyphenylene sulfide (PPS)

PPS is a soft polymer which is known for its high break resistance and very high chemical compatibility. It can be used with most organic, pH neutral to pH high, and aqueous solvents at room temperature without concerns. However, it is not recommended for using with chlorinated, oxidizing and reducing solvents, inorganic acids or at higher temperatures. Maximum operating temperature: 50 °C.

Polytetrafluorethylene (PTFE, Teflon®)

PTFE is very soft and anti-adhesive. This material is resistant against almost all acids, lyes and solvents, except against fluid sodium and fluoride compounds. In addition, it is temperature-resistant from -200 °C to +260 °C.

Systec AF™

This amorphous perfluorinated copolymer is inert against all commonly used solvents. However, it is soluble in perfluorinated solvents like Fluorinert® FC-75 and FC-40, and Fomblin perfluor-polyether solvents from Ausimont. In addition, it is affected by Freon® solvents.

Polychlorotrifluoroethylene (PCTFE, Kel-F®)

The semi-crystalline thermoplastic material is plasticizer-free and dimensionally stable, even in a wide temperature range (-240 °C to +205 °C). It is moderately resistant against ether, halogenated solvents and toluene. Halogenated solvents over +60 °C and chlorine gas should not be used.

Fluorinated rubber (FKM)

The elastomer consisting of fluorinated hydrocarbon stands out due to a high resistance against mineral oils, synthetic hydraulic fluids, fuels, aromatics, and many organic solvents and chemicals. However, it is not compatible with strong alkaline solvents (pH value > 13) like ammonia, and acidic solvents (pH value < 1), pyrrole and THF. Operating temperature: Between -40 °C and +200 °C.

Perfluorinated rubber (FFKM)

This perfluoro elastomer has a higher fluorine content as fluorinated rubber and is therefore chemically more resistant. It can be employed at higher temperatures (up to 275 °C). It is not compatible with Pyrrole.

19.3 Non-metals

Diamond-like carbon (DLC)

This material is characterized by a high hardness, a low coefficient of friction and thus low wear. In addition, it is highly biocompatible. DLC is inert against all acids, alkalis and solvents commonly used in HPLC.

Ceramic

Ceramic is resistant against corrosion and wear and is fully biocompatible. An incompatibility against acids, alkalis and solvents commonly used in HPLC is not known.

Alumina (Al₂O₃)

Due to their high resistance to wear and corrosion, alumina ceramic is used as a coating for mechanically stressed surfaces. It is a biocompatible material with low thermal conductivity and low thermal expansion.

Zirconium oxide (ZrO₂)

Zirconia ceramics are characterized by their high mechanical resistance, which makes them particularly resistant to wear and corrosion. It is also biocompatible, has low thermal conductivity and is resistant to high pressures.

Sapphire

Synthetic sapphire is virtually pure monocrystalline alumina. It is biocompatible and very resistant to corrosion and wear. The material is characterized by a high hardness and a high thermal conductivity.

Ruby

Synthetic ruby is monocrystalline alumina and gets its red color by the addition of some chromium oxide. It is biocompatible and very resistant to corrosion and wear. The material is characterized by a high hardness and a high thermal conductivity.

Mineral wool

This insulating material consists of glass or stone wool fibres and isolates in high oxidizing conditions and at high temperatures. Mineral wool is valid as commonly inert against organic solvents and acids.

Glass, glass fibre, quartz, quartz glass

These mineral materials are resistant against corrosion and wear and are mostly chemical inert. They are compatible with oils, fats and solvents and show a high resistance against acids and lyes up to pH values of 3-9. Concentrated acids (especially hydrofluoric acid) may embrittle and corrode the minerals. Lyes may ablate the surfaces slowly.

19.4 Metals

Stainless steel

Stainless steel is, apart from PEEK, the standard material in HPLC. Steels with WNr. 1.4404 (316L) are used, or with a mixture of higher compatibility.

They are inert against almost all solvents. Exceptions are biological applications which are metal ion sensitive, and applications with extreme corrosive conditions. These steels, in comparison to commonly used steels, are increasingly resistant against hydrochloric acid, cyanides and other halogen acids, chlorides and chlorinated solvents.

The use in ion chromatography is not recommended. In case of electrochemical applications, a passivation has to be executed first.

Hastelloy®-C



This nickel-chrome-molybdenum alloy is extremely resistant to corrosion, especially against oxidizing, reducing and mixed solvents, even at high temperatures. This alloy may be used in combination with chlor, formic acid, acetic acid and saline solutions.

Titanium, titanium alloy (TiAl6V4)

Titanium has a low weight and a high hardness and stability. It stands out due to its very high chemical compatibility and biocompatibility. Titan is applied when neither stainless steel nor PEEK are usable.

Appendix: Installation Qualification (IQ)

Installation Qualification (IQ) for a Device

	Created	Reviewed	Approved
Function	Technical editor	Engineering	Head of Quality
Name	Anna Erben	Paul Pietsch	Kate Monks
Date	23/08/2022	29/08/2022	30/08/2022
Signature	 <small>Digital unterschrieben von Anna Erben Datum: 2022.08.23 14:09:27 +02'00'</small>		

0. Customer approval

Prior to installation at the customer site, the customer has reviewed the OQ document and agrees with the design and scope

Company name:

Name	Function	Reviewed & approved	Date	Signature

Installation Qualification (IQ) for a Device

1. Definition of the Installation Qualification

The qualification document „Installation Qualification (IQ)“ is part of the quality management system at the company KNAUER Wissenschaftliche Geräte GmbH.

2. Scope

The customer can request the Installation Qualification. In case of a request, the technical support of KNAUER or a provider authorized by KNAUER performs this functionality test during the installation. The IQ is a standardized document and includes the following:

- Confirmation of flawless condition at delivery
- Check if the delivery is complete
- Certification on the functionality of the device

3. Instructions

All deviations from the specifications that occurred during installation have to be recorded in this document.

In addition, all measures taken to eliminate the deviations have to be noted down as comments in the list of rectifications (LOR) on page 4.

If certain items in the report are not applicable, this has to be indicated in the table as „N/A“ (not applicable). Major sections that are not used have to be crossed out (diagonal line), marked „N/A“, dated and signed.

All required documents have to be completed by the end of the installation. The document has to be reviewed and approved by an authorized person. The review and approval have to be documented with signature and date (DD/MM/YYYY).

The tests have to be carried out in a suitable environment, as described in the user instruction of the device.

4. About this document

The information in this document is subject to change without prior notice. This document may not be used, reproduced or translated without written consent of KNAUER Wissenschaftliche Geräte GmbH. Depending on the customer's quality assurance system, the signed document either has to be filed in the device folder or scanned and stored in an electronic archive.

5. Device data

Device name		Product number	
Serial number		Order number	
Firmware version			
Installation location			

6. Customer and manufacturer data

	Customer	Manufacturer
Company		KNAUER Wissenschaftliche Geräte GmbH
Customer number		-
Contact person/agent		
Address		Hegauer Weg 38
Postal Code/City		14163 Berlin
Phone		+49 30 80 97 27 111
E-Mail		support@knauer.net

Installation Qualification (IQ) for a Device

7. Installation Qualification Tests

Test	Description	Specification	Passed	Failed	N/A	Comment/LOR No.
1	Identify the device.	The name on the device matches the name on the delivery order.				
2	Check the device for transport damage.	No transport damage is observed.				
3	Check the scope of delivery.	The scope of delivery matches the packing list and/or the delivery order.				
4	Check that the technical documentation provided is correct and complete (material documentation of wetted parts, calibration certificates etc.)	The documentation is correct and complete.				
5	Check that all equipment is properly and correctly labeled according to the delivery order and/or the labeling specifications document, if applicable.	The equipment is labeled correctly.				
6	Connect all loose parts (e.g. capillaries, tubings, measuring head) according to the user instructions.	The device is fully assembled and ready to use.				
7	Ensure that the installation site is suitable according to the user instructions.	The installation site matches the specifications in the user instructions.				
8	Connect the device to the power supply and switch it on.	The device starts (operating noise). The power LED or the display lights up.				

Installation Qualification (IQ) for a Device

8. List of rectifications (LOR)

LOR No.	Test No.	Type of deviation*	Description of the deviation	Action plan	Persons responsible	Due date	Date/signature

*Type of deviation:

A = acceptable (e.g. not a GMP-critical deviation)

N = not acceptable

Continuation of qualification activities into the next qualification phase is only possible when deviation is rectified.

T = temporarily acceptable

a) Release and use of the system is possible, even when the deviation is not rectified.

b) A continuation of qualification activities into the next qualification phase is possible, even when the deviation is not rectified

Installation Qualification (IQ) for a Device

9. List of changes to the document

Revision no.	Description of change	Additional information	Date/signature

Installation Qualification (IQ) for a Device

10. Certificate and approval

A KNAUER employee or an employee authorized by KNAUER has checked the device and performed all tests described in the IQ.

The IQ form has to be signed by an authorized person. The scope of the IQ meets the customer’s requirements.

The results of the IQ, any changes made as well as the IQ process have been documented in this form in writing. The users listed below were instructed and are familiar with how to operate the device. Both parties confirm that the IQ has been performed to the customer’s satisfaction by signing it.

10.1 Customer approval

Name	Function	Date	Signature

10.2 KNAUER agent approval

Name	Function	Date	Signature

11. Comments / recommendations

Installation Qualification (IQ) for a Device

Appendix: List of supporting documents

No.	Test no.	Description

Science with Passion



Latest KNAUER instructions online:
www.knauer.net/library

KNAUER
Wissenschaftliche Geräte GmbH
Hegauer Weg 37-38
14163 Berlin

Phone: +49 30 809727-0
Fax: +49 30 8015010
E-mail: info@knauer.net
Internet: www.knauer.net